

MSTB 2,5/ 5-GF-5,08

Order No.: 1776537

The figure shows a 10-position version of the product

<http://eshop.phoenixcontact.de/phoenix/treeViewClick.do?UID=1776537>Header, Nominal current: 12 A, Nom. voltage: 250 V, Pitch: 5.08 mm,
Number of positions: 5, Color: green, Assembly: Soldering

Commercial data

EAN	4017918038700
Pack	50 pcs.
Customs tariff	85366990
Weight/Piece	0.003816 KG
Catalog page information	Page 249 (CC-2009)

Product notes

WEEE/RoHS-compliant since:
01/01/2003

<http://www.download.phoenixcontact.com>
Please note that the data given here has been taken from the online catalog. For comprehensive information and data, please refer to the user documentation. The General Terms and Conditions of Use apply to Internet downloads.

Technical data

Dimensions / positions

Pitch	5.08 mm
Dimension a	20.32 mm
Number of positions	5
Pin dimensions	1 x 1 mm
Hole diameter	1.4 mm

Technical data

Insulating material group	IIIa
Rated surge voltage (III/3)	4 kV
Rated surge voltage (III/2)	4 kV
Rated surge voltage (II/2)	4 kV
Rated voltage (III/2)	320 V
Rated voltage (II/2)	400 V
Connection in acc. with standard	EN-VDE
Nominal current I_N	12 A
Nominal voltage U_N	250 V
Maximum load current	12 A
Insulating material	PBT
Inflammability class acc. to UL 94	V0

Certificates / Approvals



Certification CB, CSA, CUL, GL, GOST, RS, UL, VDE-PZI

CSA

Nominal voltage U_N	300 V
Nominal current I_N	10 A

CUL

Nominal voltage U_N	300 V
Nominal current I_N	10 A

UL

Nominal voltage U_N	300 V
Nominal current I_N	10 A

Accessories

Item	Designation	Description
Assembly		
1755477	MSTB-BL	Keying cap, for forming sections, plugs onto header pin, green insulating material

Marking		
1051993	B-STIFT	Marker pen, for manual labeling of unprinted Zack strips, smear-proof and waterproof, line thickness 0.5 mm
0804293	SK 5,08/3,8:FORTL.ZAHLEN	Marker card, printed horizontally, self-adhesive, 12 identical decades marked 1-10, 11-20 etc. up to 91-(99)100, sufficient for 120 terminal blocks
0805085	SK 5,08/3,8:SO	Marker card, special printing, self-adhesive, labeled acc. to customer requirements, 12 identical marker strips per card, max. 25-position labeling per strip, color: white
0805412	SK 5,08/3,8:UNBEDRUCKT	Marker cards, unprinted, with pitch divisions, self-adhesive, 10-section marker strips, 12 strips per card, can be labeled with the M-PEN

Plug/Adapter		
1734401	CR-MSTB	Coding section, inserted into the recess in the header or the inverted plug, red insulating material

Additional products

Item	Designation	Description
General		
1873236	FKC 2,5/ 5-STF-5,08	Plug component, Nominal current: 12 A, Nom. voltage: 250 V, Pitch: 5.08 mm, Number of positions: 5, Connection type: Spring-cage conn., Color: green
1902330	FKCT 2,5/ 5-STF-5,08	Plug component, Nominal current: 12 A, Nom. voltage: 250 V, Pitch: 5.08 mm, Number of positions: 5, Connection type: Spring-cage conn., Color: green
1874138	FKCVR 2,5/ 5-STF-5,08	Plug component, Nominal current: 12 A, Nom. voltage: 250 V, Pitch: 5.08 mm, Number of positions: 5, Connection type: Spring-cage conn., Color: green
1873838	FKCVW 2,5/ 5-STF-5,08	Plug component, Nominal current: 12 A, Nom. voltage: 250 V, Pitch: 5.08 mm, Number of positions: 5, Connection type: Spring-cage conn., Color: green
1777837	FRONT-MSTB 2,5/ 5-STF-5,08	Plug component, Nominal current: 12 A, Nom. voltage: 250 V, Pitch: 5.08 mm, Number of positions: 5, Connection type: Screw connection, Color: green

1778014	MSTB 2,5/ 5-STF-5,08	Plug component, Nominal current: 12 A, Nom. voltage: 250 V, Pitch: 5.08 mm, Number of positions: 5, Connection type: Screw connection, Color: green
1809763	MSTBC 2,5/ 5-STZF-5,08	Plug component, Nominal current: 12 A, Nom. voltage: 320 V, Pitch: 5.08 mm, Number of positions: 5, Connection type: Crimp connection, Color: green
1805330	MSTBT 2,5/ 5-STF-5,08	Plug component, Nominal current: 12 A, Nom. voltage: 250 V, Pitch: 5.08 mm, Number of positions: 5, Connection type: Screw connection, Color: green
1849118	MSTBVK 2,5/ 5-STF-5,08	Plug component, Nominal current: 12 A, Nom. voltage: 320 V, Pitch: 5.08 mm, Number of positions: 5, Connection type: Screw connection, Assembly: DIN rail, Color: green
1835122	MVSTBR 2,5/ 5-STF-5,08	Plug component, Nominal current: 12 A, Nom. voltage: 250 V, Pitch: 5.08 mm, Number of positions: 5, Connection type: Screw connection, Color: green
1834932	MVSTBW 2,5/ 5-STF-5,08	Plug component, Nominal current: 12 A, Nom. voltage: 250 V, Pitch: 5.08 mm, Number of positions: 5, Connection type: Screw connection, Color: green
1883381	QC 1/ 5-STF-5,08	Plug component, Nominal current: 10 A, Nom. voltage: 500 V, Pitch: 5.08 mm, Number of positions: 5, Connection type: Insulation displacement connection QUICKON, Color: green
1853133	TMSTBP 2,5/ 5-STF-5,08	Plug component, Nominal current: 12 A, Nom. voltage: 250 V, Pitch: 5.08 mm, Number of positions: 5, Connection type: Screw connection, Color: green
1859205	UMSTBVK 2,5/ 5-STF-5,08	Plug component, Nominal current: 12 A, Nom. voltage: 320 V, Pitch: 5.08 mm, Number of positions: 5, Connection type: Screw connection, Assembly: DIN rail, Color: green

Diagrams/Drawings

Drilling plan/solder pad geometry

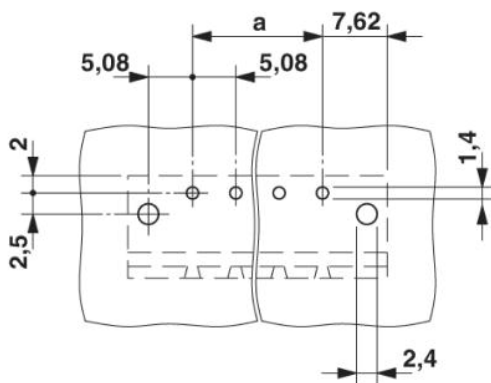

Diagram

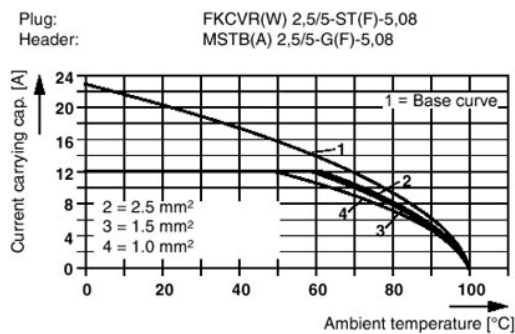
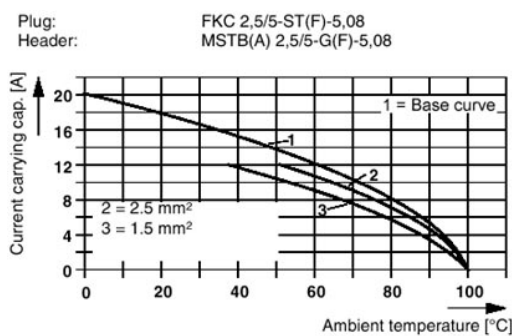
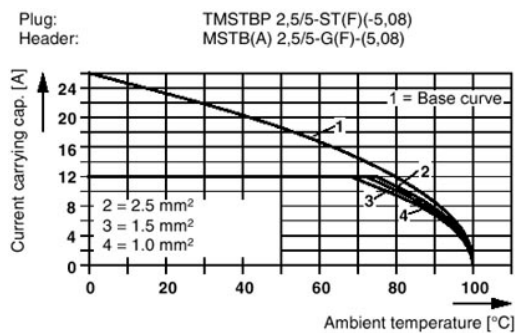
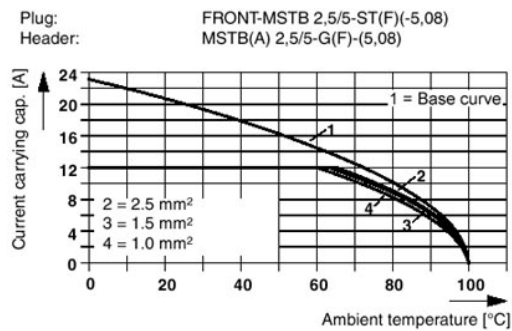
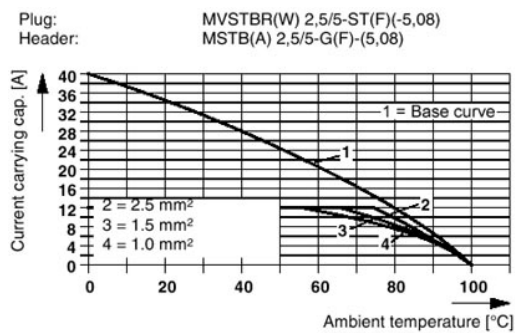
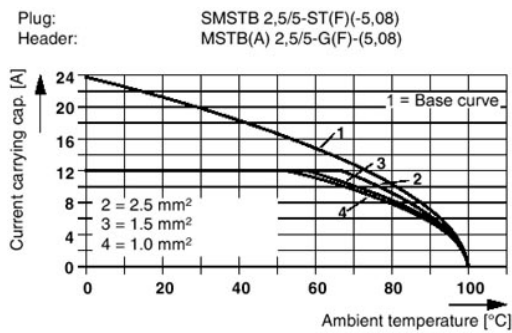
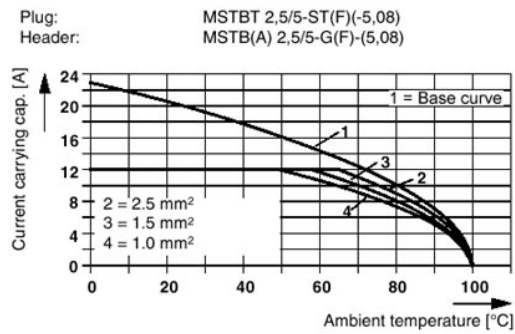
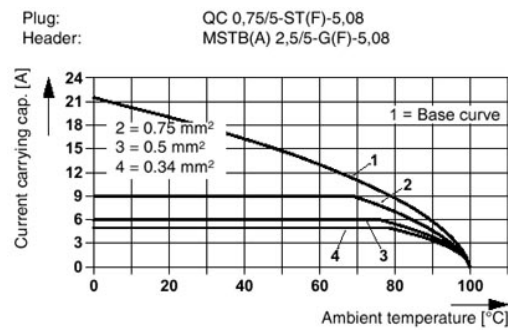

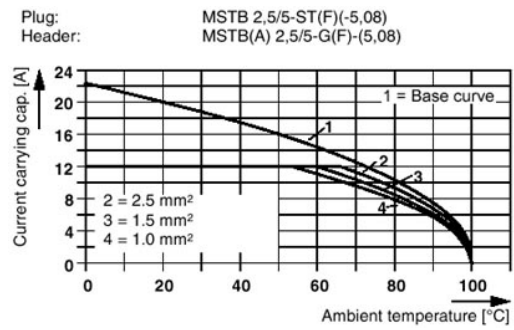
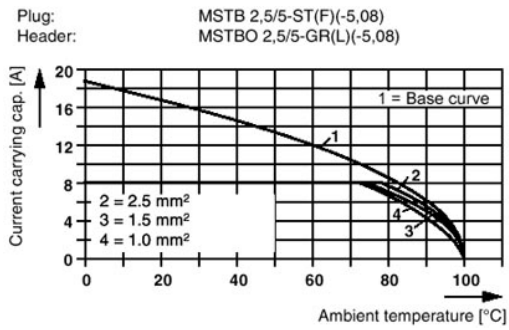

Dimensioned drawing

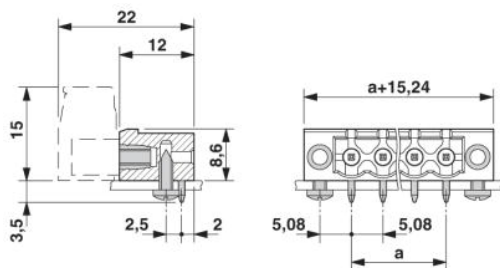

Address

PHOENIX CONTACT Inc., USA
586 Fulling Mill Road
Middletown, PA 17057, USA
Phone (800) 888-7388
Fax (717) 944-1625
<http://www.phoenixcon.com>



© 2010 Phoenix Contact
Technical modifications reserved;