

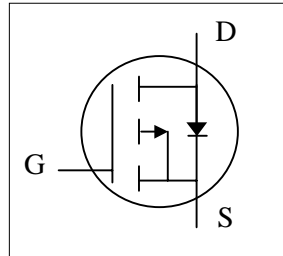

- ▼ Lower Gate Charge
- ▼ Simple Drive Requirement
- ▼ Fast Switching Characteristic



BV_{DSS}	-100V
$R_{DS(ON)}$	80m Ω
I_D	-25A

Description

Advanced Power MOSFETs from APEC provide the designer with the best combination of fast switching, ruggedized device design, low on-resistance and cost-effectiveness.

The TO-220CFM isolation package is widely preferred for commercial-industrial through hole applications.

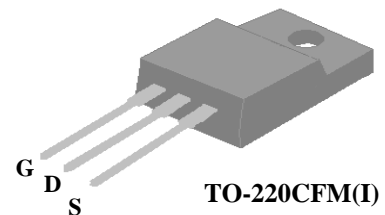

Absolute Maximum Ratings

Symbol	Parameter	Rating	Units
V_{DS}	Drain-Source Voltage	-100	V
V_{GS}	Gate-Source Voltage	± 20	V
$I_D@T_C=25^\circ C$	Continuous Drain Current, V_{GS} @ 10V	-25	A
$I_D@T_C=100^\circ C$	Continuous Drain Current, V_{GS} @ 10V	-15	A
I_{DM}	Pulsed Drain Current ¹	-80	A
$P_D@T_C=25^\circ C$	Total Power Dissipation	31.3	W
T_{STG}	Storage Temperature Range	-55 to 150	$^\circ C$
T_J	Operating Junction Temperature Range	-55 to 150	$^\circ C$

Thermal Data

Symbol	Parameter	Value	Units
Rthj-c	Maximum Thermal Resistance, Junction-case	4.0	$^\circ C/W$
Rthj-a	Maximum Thermal Resistance, Junction-ambient	65	$^\circ C/W$



AP30P10GI

Electrical Characteristics @T_j=25°C(unless otherwise specified)

Symbol	Parameter	Test Conditions	Min.	Typ.	Max.	Units
BV _{DSS}	Drain-Source Breakdown Voltage	V _{GS} =0V, I _D =-1mA	-100	-	-	V
R _{DS(ON)}	Static Drain-Source On-Resistance ²	V _{GS} =-10V, I _D =-12A	-	-	80	mΩ
		V _{GS} =-4.5V, I _D =-8A	-	-	100	mΩ
V _{GS(th)}	Gate Threshold Voltage	V _{DS} =V _{GS} , I _D =-250uA	-1	-	-3	V
g _{fs}	Forward Transconductance	V _{DS} =-10V, I _D =-12A	-	23	-	S
I _{DSS}	Drain-Source Leakage Current	V _{DS} =-80V, V _{GS} =0V	-	-	-25	uA
I _{GSS}	Gate-Source Leakage	V _{GS} = ±20V	-	-	±100	nA
Q _g	Total Gate Charge ²	I _D =-18A	-	50	80	nC
Q _{gs}	Gate-Source Charge	V _{DS} =-80V	-	7.5	-	nC
Q _{gd}	Gate-Drain ("Miller") Charge	V _{GS} =-10V	-	16.5	-	nC
t _{d(on)}	Turn-on Delay Time ²	V _{DS} =-50V	-	12	-	ns
t _r	Rise Time	I _D =-18A	-	33	-	ns
t _{d(off)}	Turn-off Delay Time	R _G =3.3Ω, V _{GS} =-10V	-	61	-	ns
t _f	Fall Time	R _D =2.8Ω	-	78	-	ns
C _{iss}	Input Capacitance	V _{GS} =0V	-	2580	4130	pF
C _{oss}	Output Capacitance	V _{DS} =-25V	-	185	-	pF
C _{rss}	Reverse Transfer Capacitance	f=1.0MHz	-	140	-	pF

Source-Drain Diode

Symbol	Parameter	Test Conditions	Min.	Typ.	Max.	Units
V _{SD}	Forward On Voltage ²	I _S =-18A, V _{GS} =0V	-	-	-1.3	V
t _{rr}	Reverse Recovery Time ²	I _S =-18A, V _{GS} =0V,	-	53	-	ns
Q _{rr}	Reverse Recovery Charge	dI/dt=-100A/μs	-	125	-	nC

Notes:

1.Pulse width limited by Max. junction temperature.

2.Pulse test

THIS PRODUCT IS SENSITIVE TO ELECTROSTATIC DISCHARGE, PLEASE HANDLE WITH CAUTION.

USE OF THIS PRODUCT AS A CRITICAL COMPONENT IN LIFE SUPPORT OR OTHER SIMILAR SYSTEMS IS NOT AUTHORIZED.

APEC DOES NOT ASSUME ANY LIABILITY ARISING OUT OF THE APPLICATION OR USE OF ANY PRODUCT OR CIRCUIT DESCRIBED HEREIN; NEITHER DOES IT CONVEY ANY LICENSE UNDER ITS PATENT RIGHTS, NOR THE RIGHTS OF OTHERS.

APEC RESERVES THE RIGHT TO MAKE CHANGES WITHOUT FURTHER NOTICE TO ANY PRODUCTS HEREIN TO IMPROVE RELIABILITY, FUNCTION OR DESIGN.

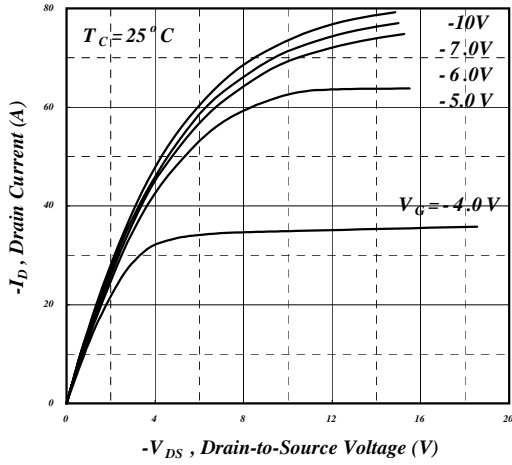

Fig 1. Typical Output Characteristics

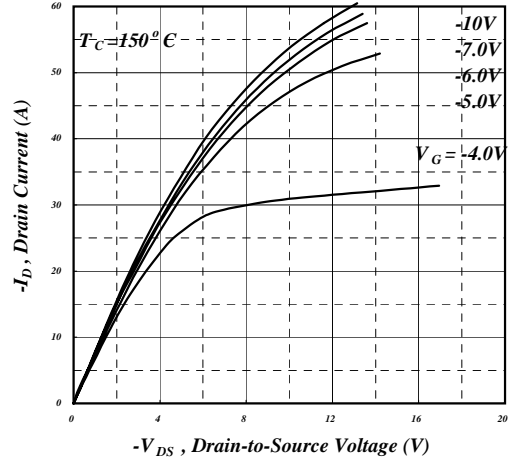

Fig 2. Typical Output Characteristics

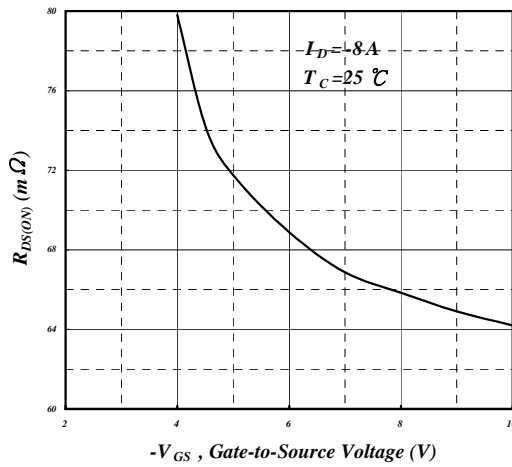

Fig 3. On-Resistance v.s. Gate Voltage

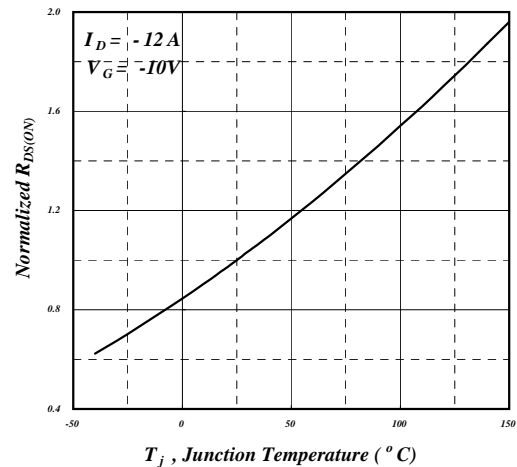

Fig 4. Normalized On-Resistance v.s. Junction Temperature

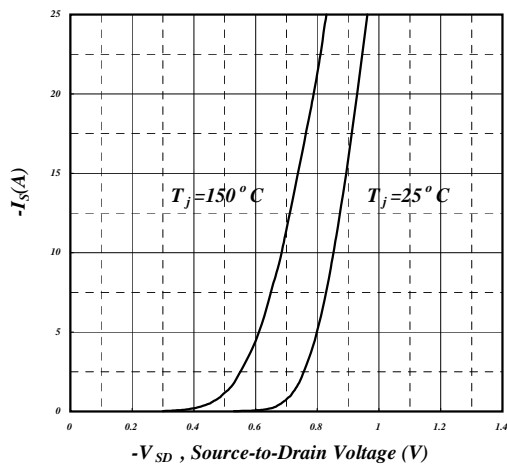

Fig 5. Forward Characteristic of Reverse Diode

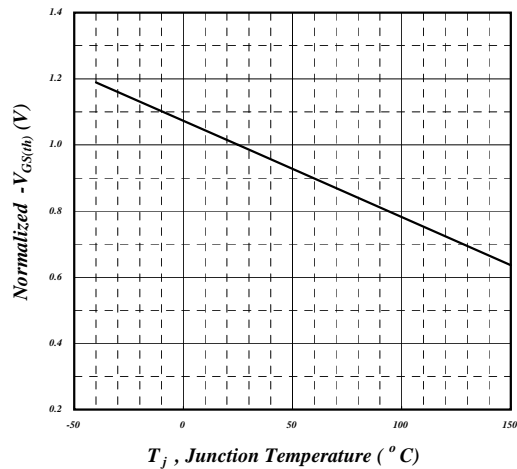

Fig 6. Gate Threshold Voltage v.s. Junction Temperature

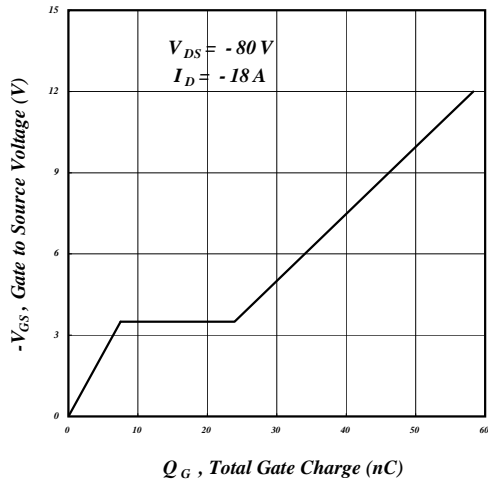

Fig 7. Gate Charge Characteristics

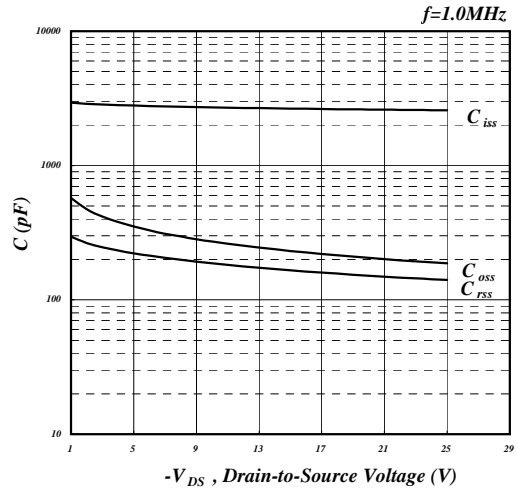

Fig 8. Typical Capacitance Characteristics

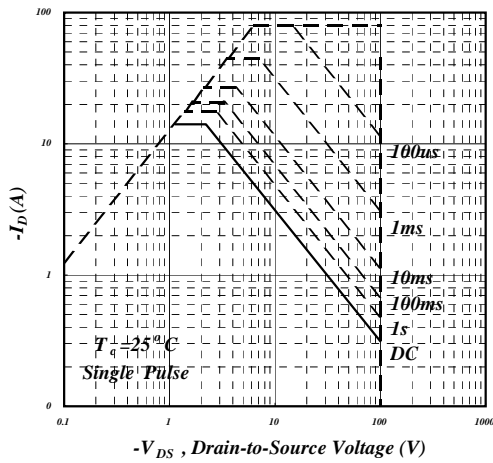

Fig 9. Maximum Safe Operating Area

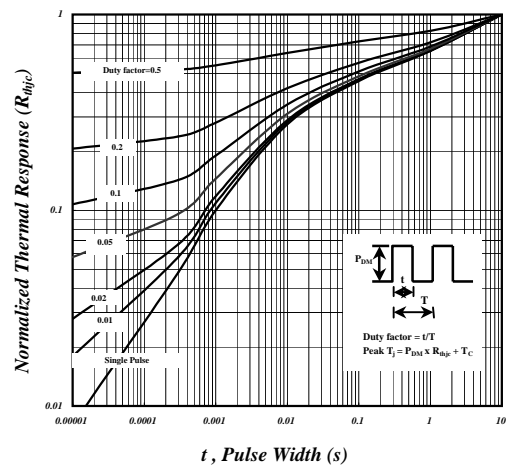

Fig 10. Effective Transient Thermal Impedance

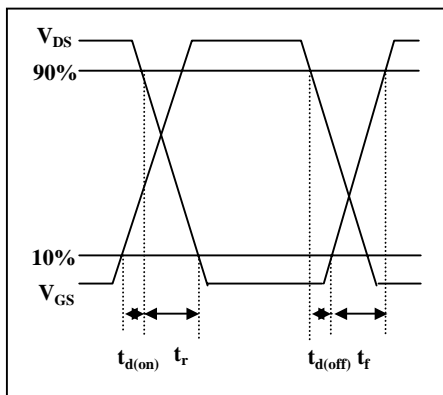

Fig 11. Switching Time Waveform

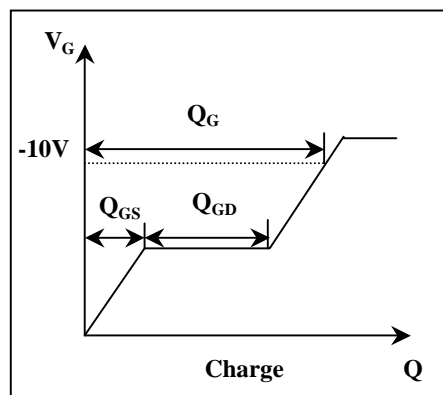
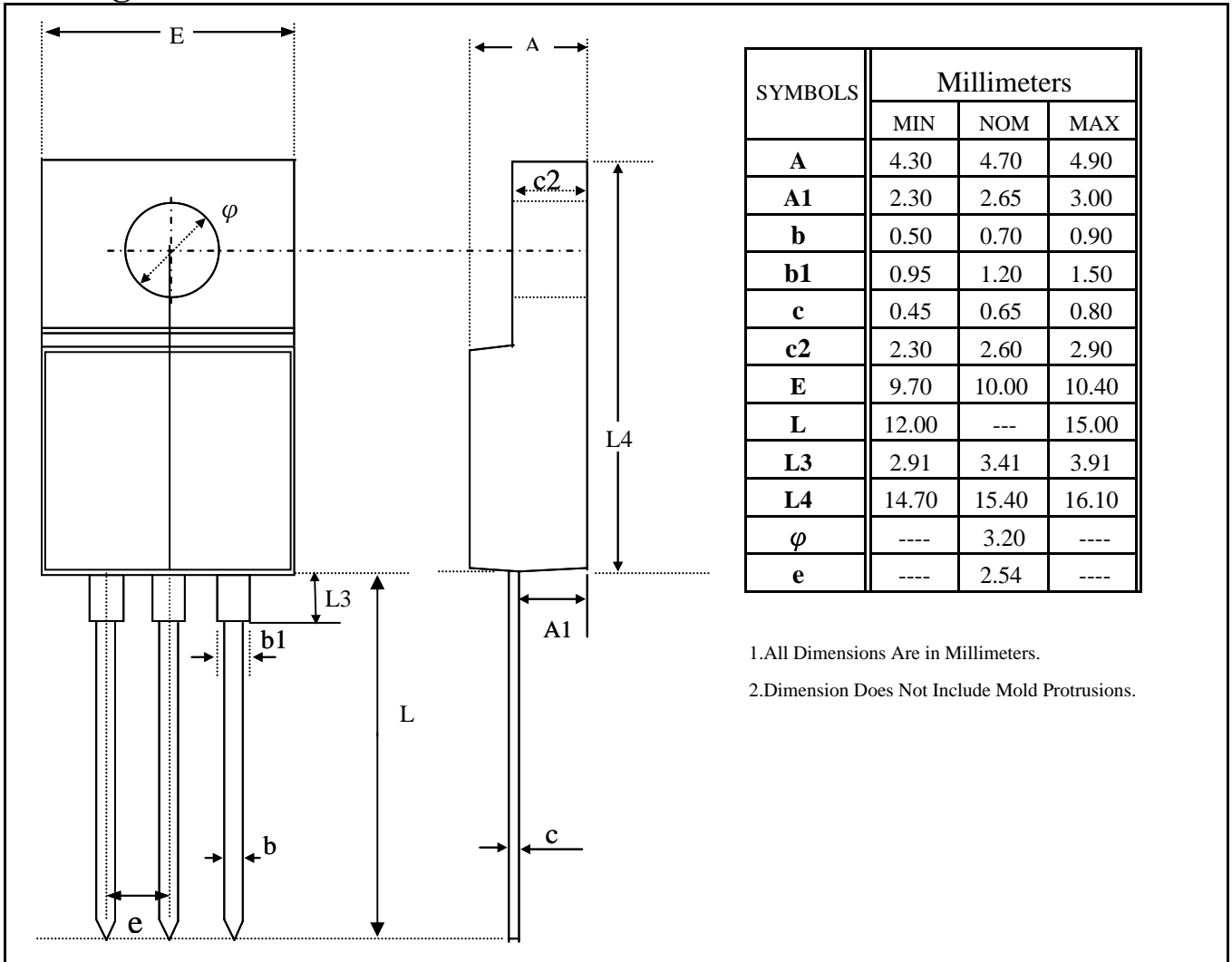

Fig 12. Gate Charge Waveform



ADVANCED POWER ELECTRONICS CORP.

Package Outline : TO-220CFM



Part Marking Information & Packing : TO-220CFM

