

Ideal for solar inverter compact size, 1a 35A/48A power relays

**HE RELAYS
PV Type**



RoHS compliant

FEATURES

• **35A/48A current at 250 V AC achieved in compact size (L: 33 × W: 38 × H: 36.3 mm L: 1.299 × W: 1.496 × H: 1.429 inch)**
Due to improved conduction efficiency, wide terminal blades are used. (for high capacity type)

• **High insulation and 10,000 V surge breakdown voltage (between contacts and coil) achieved.**
• **Conforms to various safety standards**
UL/C-UL and VDE

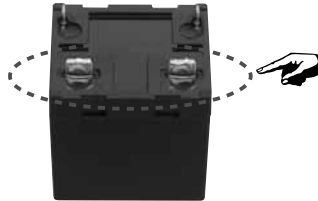

• **Contact gap: 2.5 mm (VDE0126 compliant)**
Compliant with European photovoltaic standard VDE0126
Compliant with EN61810-1 2.5 kV surge breakdown voltage (between contacts)
• **Contributes to energy saving in devices thanks to reduced coil hold voltage**
Coil hold voltage can be reduced down to 40% of the nominal coil voltage (ambient temperature 20°C 68°F). This equals to operating power of approximately 310 mW.
*Coil hold voltage is the coil voltage after 100 ms following application of the nominal coil voltage.

TYPICAL APPLICATIONS

• **Photovoltaic power generation systems (Solar inverter)**

ORDERING INFORMATION

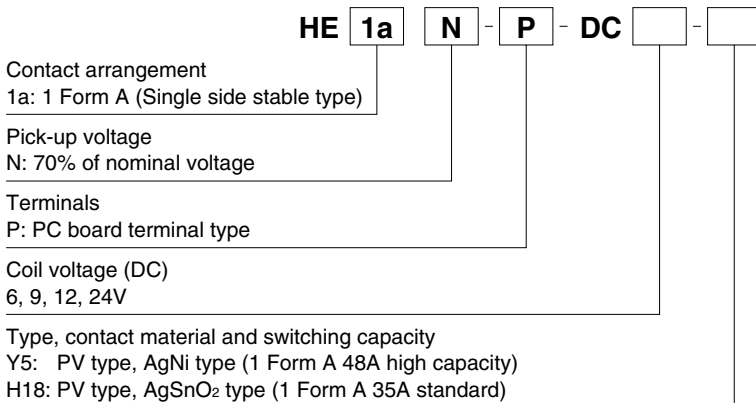

TYPES

Nominal coil voltage	Standard type*		High capacity type
	Part No.		Part No.
6V DC	HE1aN-P-DC6V-H18		HE1aN-P-DC6V-Y5
9V DC	HE1aN-P-DC9V-H18		HE1aN-P-DC9V-Y5
12V DC	HE1aN-P-DC12V-H18		HE1aN-P-DC12V-Y5
24V DC	HE1aN-P-DC24V-H18		HE1aN-P-DC24V-Y5

Standard packing: Carton: 20 pcs.; Case: 100 pcs.

*Standard 6V, 12V and 24V DC type: Certified by UL/C-UL (Standard 9V type: Certified by UL/C-UL and VDE)

RATING

1. Coil data

Nominal coil voltage	Pick-up voltage (at 20°C 68°F) (Initial)	Drop-out voltage (at 20°C 68°F) (Initial)	Nominal operating current [$\pm 10\%$] (at 20°C 68°F)	Coil resistance [$\pm 10\%$] (at 20°C 68°F)	Nominal operating power	Max. applied voltage (at 20°C 68°F)
6V DC	70%V or less of nominal voltage	10%V or more of nominal voltage	320mA	18.8 Ω	1,920mW	110%V of nominal voltage
9V DC			213mA	42.2 Ω		
12V DC			160mA	75.0 Ω		
24V DC			80mA	300.0 Ω		

2. Specifications

Characteristics	Item		Specifications	
			Standard type	High capacity type
Contact	Arrangement		1 Form A	
	Contact resistance (Initial)		Max. 100 m Ω (By voltage drop 6 V DC 1A)	
	Contact material		AgSnO ₂ type	AgNi type
Rating	Nominal switching capacity		35 A 250 V AC (Resistive load)	48 A 250 V AC (Resistive load)
	Contact carrying power		8,750 VA (Resistive load)	12,000 VA (Resistive load)
	Max. switching voltage		250 V AC	
	Max. switching current		35 A (AC)	48 A (AC)
	Nominal operating power		1,920 mW	
	Min. switching capacity (Reference value)*1		100 mA 5 V DC	
Electrical characteristics	Insulation resistance (Initial)		Min. 1,000M Ω (at 500V DC) Measurement at same location as "Breakdown voltage" section.	
	Breakdown voltage (Initial)	Between open contacts	2,000 Vrms for 1 min. (Detection current: 10 mA)	
		Between contact and coil	5,000 Vrms for 1 min. (Detection current: 10 mA)	
	Surge breakdown voltage*2 (Between contact and coil) (Initial)		10,000 V	
	Temperature rise	Max. 60°C 140°F (By resistive method, contact carrying current: 35A, 100%V of nominal coil voltage at 55°C 131°F.)		Max. 60°C 140°F (By resistive method, contact carrying current: 48A, 100%V of nominal coil voltage at 55°C 131°F.)
		Max. 30°C 86°F (By resistive method, contact carrying current: 35A, 60%V of nominal coil voltage at 85°C 185°F.)		Max. 30°C 86°F (By resistive method, contact carrying current: 48A, 60%V of nominal coil voltage at 85°C 185°F.)
	Coil hold voltage*3		40 to 100%V (Contact carrying current: 35A, at 20°C 68°F), 50 to 100%V (Contact carrying current: 35A, at 55°C 131°F), 50 to 60%V (Contact carrying current: 35A, at 85°C 185°F)	40 to 100%V (Contact carrying current: 48A, at 20°C 68°F), 50 to 100%V (Contact carrying current: 48A, at 55°C 131°F), 50 to 60%V (Contact carrying current: 48A, at 85°C 185°F)
	Operate time (at 20°C 68°F)		Max. 30 ms (nominal coil voltage, excluding contact bounce time)	
Release time (at 20°C 68°F)*5		Max. 10 ms (nominal coil voltage, excluding contact bounce time) (without diode)		
Mechanical characteristics	Shock resistance	Functional	Min. 98 m/s ² (Half-wave pulse of sine wave: 11 ms; detection time: 10 μ s.)	
		Destructive	Min. 980 m/s ² (Half-wave pulse of sine wave: 6 ms.)	
	Vibration resistance	Functional	10 to 55 Hz at double amplitude of 1.0 mm (Detection time: 10 μ s.)	
		Destructive	10 to 55 Hz at double amplitude of 1.5 mm	
Expected life	Mechanical		Min. 10 ⁶ (at 180 times/min.)	
	Electrical	Resistive load	Min. 3 \times 10 ⁴ (35 A 250 V AC) (ON : OFF = 1s : 9s)	Min. 3 \times 10 ⁴ (48 A 250 V AC) (ON : OFF = 1s : 9s)
Inductive load		—	Endurance: 48 A 250 V AC (cos ϕ = 0.8), Min. 3 \times 10 ⁴ (ON : OFF = 0.1s : 10s) Overload: 72 A 250 V AC (cos ϕ = 0.8), Min. 50 (ON : OFF = 0.1s : 10s)	
Conditions	Conditions for operation, transport and storage*4		Ambient temperature: -50 to +55°C -58 to +131°F (When nominal coil voltage applied) -50 to +85°C -58 to +185°F (When applied coil hold voltage is 50% to 60% of nominal coil voltage) Humidity: 5 to 85% R.H. (Not freezing and condensing at low temperature); Atmospheric pressure: 86 to 106 kPa	
	Max. operating speed		6 times/min. (at nominal switching capacity ON : OFF = 1s : 9s)	
Unit weight			Approx. 80 g 2.82 oz	

Notes: *1. This value can change due to the switching frequency, environmental conditions, and desired reliability level, therefore it is recommended to check this with the actual load.

*2. Wave is standard shock voltage of $\pm 1.2 \times 50 \mu$ s according to JEC-212-1981

*3. Coil hold voltage is the coil voltage after 100 ms following application of the nominal coil voltage.

*4. The upper operation ambient temperature limit is the maximum temperature that can satisfy the coil temperature rise value. Refer to Usage, transport and storage conditions in NOTES.

*5. Release time will lengthen if a diode, etc., is connected in parallel to the coil. Be sure to verify operation under actual conditions.

HE PV Type

REFERENCE DATA

1.-(1) Coil temperature rise (Standard type)

Sample: HE1aN-P-DC9V-H18, 6 pcs.
 Point measured: coil inside
 Ambient temperature: 25°C 77°F, 60°C 140°F, 85°C 185°F
 Contact carrying current: 35A

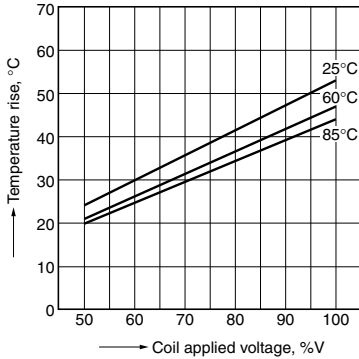

1.-(2) Coil temperature rise (High capacity type)

Sample: HE1aN-P-DC9V-Y5, 6 pcs.
 Point measured: coil inside
 Ambient temperature: 25°C 77°F, 60°C 140°F, 85°C 185°F
 Contact carrying current: 48A

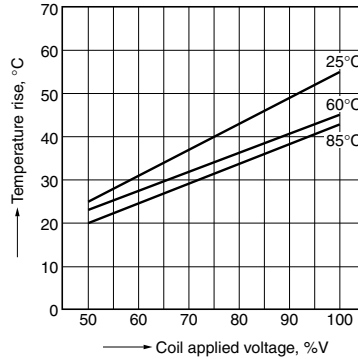

2.-(1) Electrical life test (Standard type, Resistive load 250V AC, 35A at 85°C 185°F)

Sample: HE1aN-P-DC9V-H18, 6 pcs.
 Operation frequency: 6 times/min.
 (ON/OFF = 1.0s : 9.0s)

Circuit:

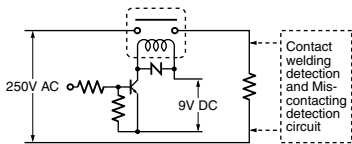

Change of pick-up and drop-out voltage

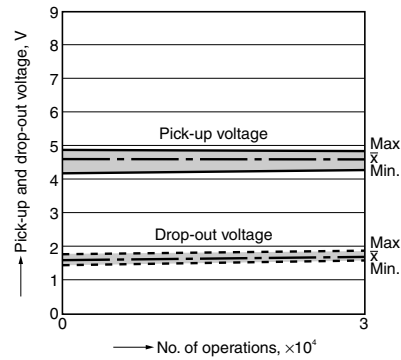

Change of contact resistance

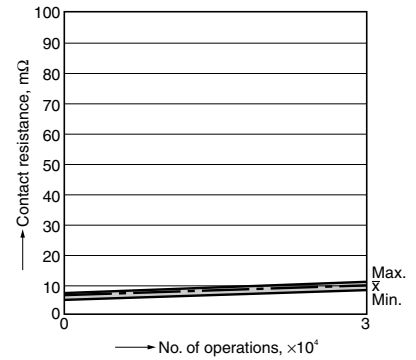

2.-(2) Electrical life test (High capacity type, Resistive load 250V AC, 48A at 85°C 185°F)

Sample: HE1aN-P-DC9V-Y5, 6 pcs.
 Operation frequency: 6 times/min.
 (ON/OFF = 1.0s : 9.0s)

Circuit:

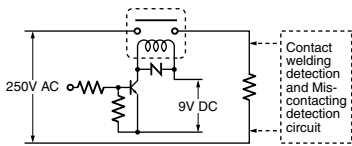

Change of pick-up and drop-out voltage

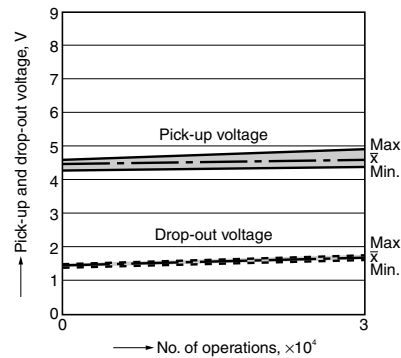

Change of contact resistance

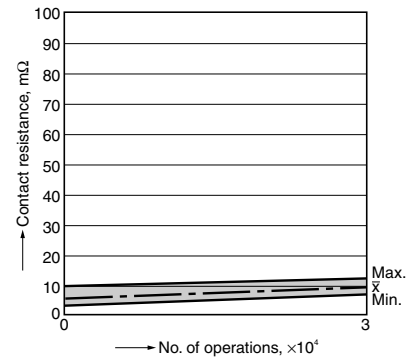

DIMENSIONS (mm inch)

The CAD data of the products with a **CAD Data** mark can be downloaded from: <http://industrial.panasonic.com/ac/e/>

CAD Data

Standard type



External dimensions

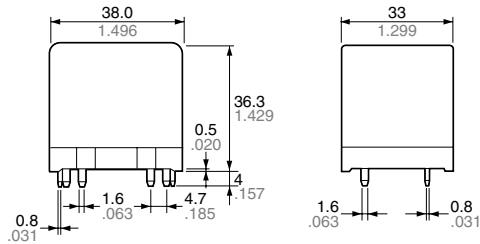

General tolerance: $\pm 0.3 \pm 0.12$

Schematic (Bottom view)

Single side stable type

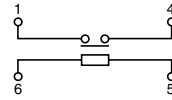

PC board pattern (Bottom view)

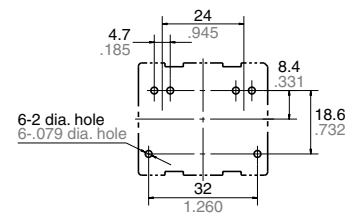

Tolerance: $\pm 0.1 \pm 0.04$

High capacity type

External dimensions

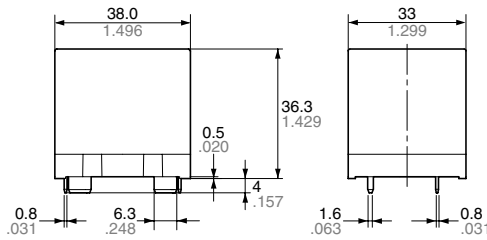

General tolerance: $\pm 0.3 \pm 0.12$

Schematic (Bottom view)

Single side stable type

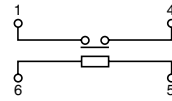

PC board pattern (Bottom view)

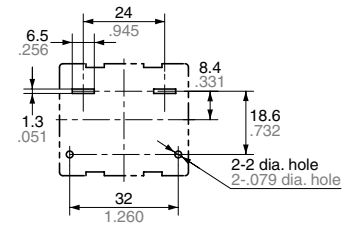

Tolerance: $\pm 0.1 \pm 0.04$

SAFETY STANDARDS

Certification authority		
High capacity type	C-UL	48 A 277 V AC (at 85°C 185°F)
	VDE (VDE0435)	48 A 250 V AC $\cos\phi = 0.8$ (at 85°C 185°F)
Standard type	UL, CSA	35 A 277 V AC (at 25°C 77°F)
	VDE (VDE0435)*	35 A 250 V AC $\cos\phi = 1$ (at 80°C 176°F)

*Only 9V DC type is certified.

NOTES

Usage, transport and storage conditions

1) Temperature:

-50 to +55°C -58 to +131°F

-50 to +85°C -58 to +185°F (When applied coil hold voltage is 50% to 60% of nominal coil voltage)

2) Humidity: 5 to 85% RH

(Avoid freezing and condensation.)

The humidity range varies with the temperature. Use within the range indicated in the graph below.

3) Atmospheric pressure: 86 to 106 kPa

Temperature and humidity range for usage, transport, and storage

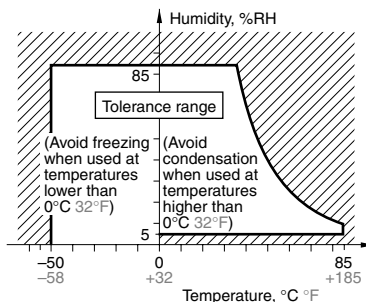
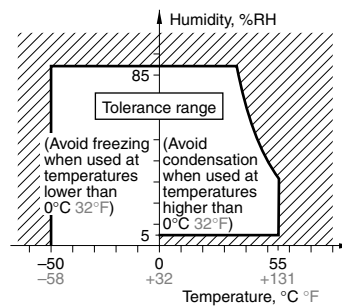

* -50 to +85°C -58 to +185°F (When applied coil hold voltage is 50% to 60% of nominal coil voltage)

Certification

This relay is UL/C-UL certified.

48 A 277 V AC (High capacity type)

35 A 277 V AC (Standard type)

This relay is certified by VDE

48 A 250 V AC $\cos\phi = 0.8$

(High capacity type)

35 A 250 V AC $\cos\phi = 1$

(Standard type)

For Cautions for Use.