

MBR1535CT - MBR15150CT

15.0 AMPS. Schottky Barrier Rectifiers

TO-220AB



Features

- ✧ Plastic material used carries Underwriters Laboratory Classifications 94V-0
- ✧ Metal silicon junction, majority carrier conduction
- ✧ Low power loss, high efficiency
- ✧ High current capability, low forward voltage drop
- ✧ High surge capability
- ✧ For use in low voltage, high frequency inverters, free wheeling, and polarity protection applications
- ✧ Guardring for overvoltage protection
- ✧ High temperature soldering guaranteed: 260°C/10 seconds, 0.25"(6.35mm) from case

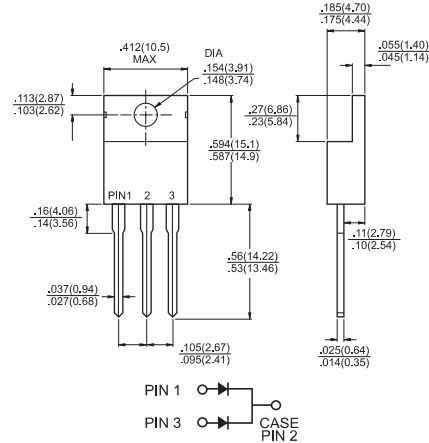

Mechanical Data

- ✧ Cases: JEDEC TO-220AB molded plastic body
- ✧ Terminals: Pure tin plated, lead free. solderable per MIL-STD-750, Method 2026
- ✧ Polarity: As marked
- ✧ Mounting position: Any
- ✧ Mounting torque: 5 in. - lbs. max
- ✧ Weight: 0.08 ounce, 2.24 grams

Dimensions in inches and (millimeters)

Maximum Ratings and Electrical Characteristics

Rating at 25 °C ambient temperature unless otherwise specified.
Single phase, half wave, 60 Hz, resistive or inductive load.
For capacitive load, derate current by 20%

Type Number	Symbol	MBR 1535CT	MBR 1545CT	MBR 1550CT	MBR 1560CT	MBR 1590CT	MBR 15100CT	MBR 15150CT	Units	
Maximum Recurrent Peak Reverse Voltage	V_{RRM}	35	45	50	60	90	100	150	V	
Maximum RMS Voltage	V_{RMS}	24	31	35	42	63	70	105	V	
Maximum DC Blocking Voltage	V_{DC}	35	45	50	60	90	100	150	V	
Maximum Average Forward Rectified Current at $T_C=105^\circ\text{C}$	$I_{(AV)}$	15							A	
Peak Repetitive Forward Current (Rated V_R , Square Wave, 20KHz) at $T_C=105^\circ\text{C}$	I_{FRM}	15							A	
Peak Forward Surge Current, 8.3 ms Single Half Sine-wave Superimposed on Rated Load (JEDEC method)	I_{FSM}	150							A	
Peak Repetitive Reverse Surge Current (Note 1)	I_{RRM}	1.0		0.5				A		
Maximum Instantaneous Forward Voltage at: (Note 2) $I_F=7.5\text{A}, T_C=25^\circ\text{C}$ $I_F=7.5\text{A}, T_C=125^\circ\text{C}$ $I_F=15\text{A}, T_C=25^\circ\text{C}$ $I_F=15\text{A}, T_C=125^\circ\text{C}$	V_F	0.57 0.84 0.72 —	— 0.65 — —	0.75 0.65 — —	— — — —	0.92 0.82 — —	— — — —	1.05 0.92 — —	V	
Maximum Instantaneous Reverse Current @ $T_C=25^\circ\text{C}$ at Rated DC Blocking Voltage @ $T_C=125^\circ\text{C}$ (Note 2)	I_R	0.5 10	— —	0.3 7.5	— —	— —	0.1 5.0	— —	mA mA	
Voltage Rate of Change (Rated V_R)	dV/dt	1,000							V/ μS	
Typical Junction Capacitance	C_j	400				200			pF	
Maximum Typical Thermal Resistance (Note 3)	$R_{\theta JA}$ $R_{\theta JC}$	10 1.5					—			$^\circ\text{C}/\text{W}$
Operating Junction Temperature Range	T_J	-65 to +150							$^\circ\text{C}$	
Storage Temperature Range	T_{STG}	-65 to +175							$^\circ\text{C}$	



KERSEMI

RATINGS AND CHARACTERISTIC CURVES (MBR1535CT THRU MBR15150CT)

FIG.1- FORWARD CURRENT DERATING CURVE

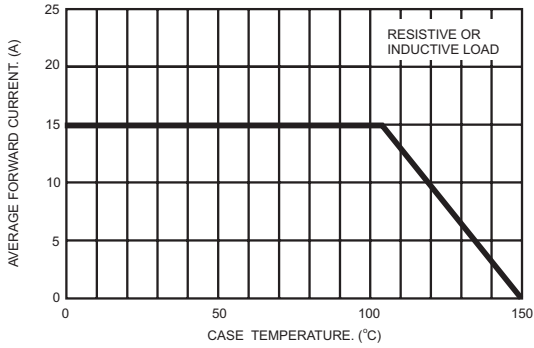

FIG.2- MAXIMUM NON-REPETITIVE FORWARD SURGE CURRENT PER LEG

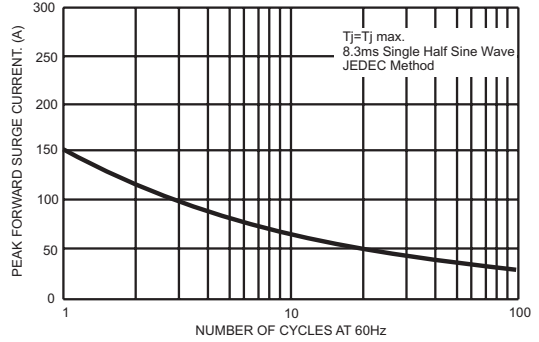

FIG.3- TYPICAL INSTANTANEOUS FORWARD CHARACTERISTICS PER LEG

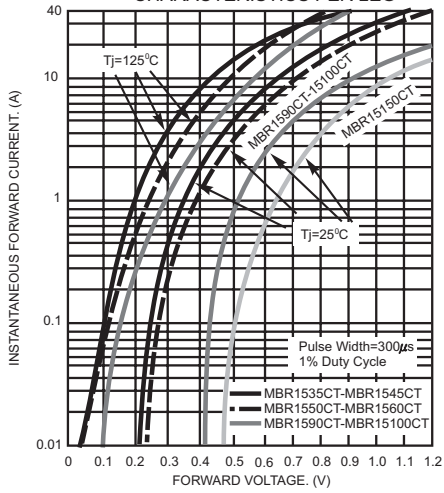

FIG.4- TYPICAL REVERSE CHARACTERISTICS PER LEG

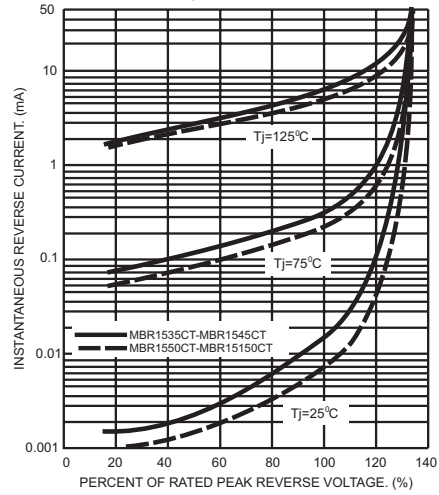

FIG.5- TYPICAL JUNCTION CAPACITANCE PER LEG

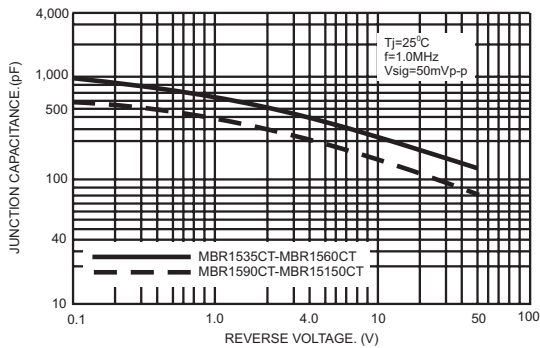
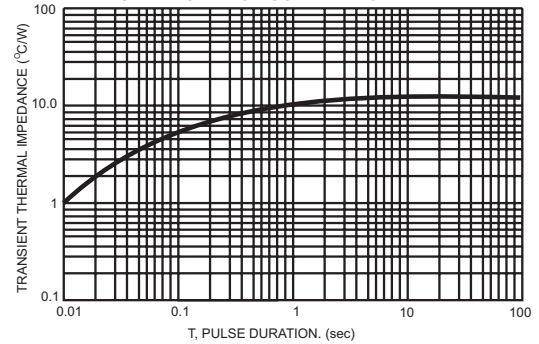

FIG.6- TYPICAL TRANSIENT THERMAL CHARACTERISTICS PER LEG



www.kersemi.com