

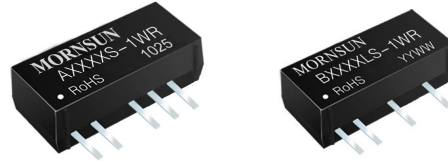

Continuous Short  
Circuit Protection

## A\_S-1WR & B\_LS-1WR Series 1W, FIXED INPUT, ISOLATED & UNREGULATED DUAL/SINGLE OUTPUT DC-DC CONVERTER



Patent Protection RoHS

### FEATURES

- SIP Package
- Output Short Circuit Protection
- Low Isolation Capacitance
- 1000VDC Isolation Voltage
- Operating Temperature: -40°C~+85°C
- Internal SMD construction
- Industry Standard Pinout
- RoHS Compliance

### APPLICATIONS

The A\_S-1WR & B\_LS-1WR Series are specially designed for applications where a group of polar power supplies are isolated from the input power supply in a distributed power supply system on a circuit board.

These products apply to:

- 1) Where the voltage of the input power supply is fixed (voltage variation  $\leq \pm 10\%$ );
- 2) Where isolation is necessary between input and output (isolation voltage  $\leq 1000\text{VDC}$ );
- 3) Where the regulation of the output voltage and the output ripple noise are not demanding.

Such as: purely digital circuits, ordinary low frequency analog circuits, and IGBT power device driving circuits.

### MODEL SELECTION

A0515S-1WR

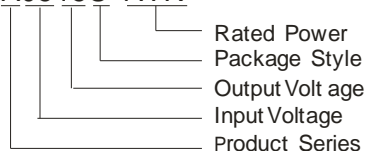

### MORNSUN Science & Technology Co.,Ltd.

Address: No. 5, Kehui St. 1, Kehui development center, Science Ave., Guangzhou Science City, Luogang district, Guangzhou, P.R. China.

Tel: 86-20-38601850

Fax: 86-20-38601272

[Http://www.mornsun-power.com](http://www.mornsun-power.com)

### PRODUCT PROGRAM

Part Number	Input		Output			Efficiency (%) (Typ.)
	Voltage (VDC)		Voltage (VDC)	Current (mA)		
	Nominal	Range		Max	Min	
B0303LS-1WR	3.3	3.0-3.6	3.3	303	30	68
B0305LS-1WR			5	200	20	70
A0505S-1WR	5	4.5-5.5	$\pm 5$	$\pm 100$	$\pm 10$	69
A0509S-1WR			$\pm 9$	$\pm 56$	$\pm 5$	73
A0512S-1WR			$\pm 12$	$\pm 42$	$\pm 4$	75
A0515S-1WR			$\pm 15$	$\pm 34$	$\pm 3$	75
<del>A0524S-1WR</del>			<del><math>\pm 24</math></del>	<del><math>\pm 24</math></del>	<del><math>\pm 2</math></del>	<del>76</del>
B0505LS-1WR			5	200	20	73
B0509LS-1WR			9	112	11	73
B0512LS-1WR			12	83	8	75
B0515LS-1WR	15	67	6	75		
B0524LS-1WR	24	42	4	76		
A1205S-1WR	12	10.8-13.2	$\pm 5$	$\pm 100$	$\pm 10$	70
A1212S-1WR			$\pm 12$	$\pm 42$	$\pm 4$	75
A1215S-1WR			$\pm 15$	$\pm 34$	$\pm 3$	76
B1205LS-1WR			5	200	20	73
B1209LS-1WR			9	112	11	72
B1212LS-1WR			12	83	8	75
B1215LS-1WR	15	67	6	76		
<del>A1505S-1WR</del>	15	13.5-16.5	<del><math>\pm 5</math></del>	<del><math>\pm 100</math></del>	<del><math>\pm 10</math></del>	<del>70</del>
B1515LS-1WR			15	67	6	75
A2405S-1WR			$\pm 5$	$\pm 100$	$\pm 10$	68
A2412S-1WR			$\pm 12$	$\pm 42$	$\pm 4$	76
A2415S-1WR			$\pm 15$	$\pm 34$	$\pm 3$	76
B2403LS-1WR			3.3	303	30	70
B2405LS-1WR	5	200	20	70		
B2412LS-1WR	12	83	8	75		
B2415LS-1WR	15	67	6	76		

Note: Models listed with strike-through text have been officially discontinued.

### COMMON SPECIFICATIONS

Item	Test conditions	Min	Typ	Max	Units
Storage humidity				95	%
Operating Temperature		-40		85	°C
Storage Temperature		-55		125	
Temp. rise at full load			20	30	
Lead temperature	1.5mm from case for 10 seconds			300	
Cooling		Free air convection			
Case material		Plastic (UL94-V0)			
Short circuit protection*		Continuous, Auto-recovery			
MTBF		1940			Khours
Weight			2.3		g

INPUT SPECIFICATIONS					
Item	Test conditions	Min	Typ	Max	Units
Input current (No load/Full load)	5V input		30/260		mA
	12V input		12/110		
	15V input		12/100		
	24V input		7/55		
Surge voltage (1S max)	5V input			9	V
	12V input			18	
	15V input			21	
	24V input			30	

OUTPUT SPECIFICATIONS					
Item	Test conditions	Min.	Typ.	Max.	Units
Output power		0.1		1	W
Line regulation	For Vin change of ±1%		±1.1	±1.5	%
Load regulation	10% to 100% load		10	20	
Output voltage accuracy	Follow the tolerance envelope graph				
Temperature drift	100% full load			±0.03	%/°C
Ripple & Noise*	20MHz Bandwidth		100	200	mVp-p
Switching frequency	Full load, nominal input		100		kHz

\*Test ripple and noise by "parallel cable" method. See detailed operation instructions at Testing of Power Converter section, application notes.

ISOLATION SPECIFICATIONS					
Item	Test conditions	Min	Typ	Max	Units
Isolation voltage	Tested for 1 minute and 1 mA max	1000			VDC
Isolation resistance	Test at 500VDC	1000			MΩ
Isolation Capacitance	Input/Output, 100KHz/0.1V		6	15	PF

## APPLICATION NOTE

### ① Requirement on output load

To ensure this module can operate efficiently and reliably, During operation, the minimum output load **could not be less than 10% of the full load**. If the actual output power is very small, please connect a resistor with resistance of 10% rated power at the output end in parallel, or use our company's products with a lower rated output power

### ② Overload Protection

Under normal operating conditions, the output circuit of these products has no protection against overload. The simplest method is to connect a slow-blow fuse in series at the input end or add a circuit breaker to the circuit.

### ③ Recommended testing and application circuit

If you want to further decrease the input ripple or the input inrush current, an "LC" filtering network may be connected to the input and output ends of the DC/DC converter, see (Figure 1).

It should also be noted that the inductance and the frequency of the "LC" filtering network should be staggered with the DC/DC frequency to avoid mutual interference. However, the capacitance of the output filter capacitor must be proper. If the capacitance is too big, a startup problem might arise. For every channel of output, provided the safe and reliable operation is ensured, the recommended capacitance of its filter capacitor sees (Table 1).

### ④ Output Voltage Regulation and Over-voltage Protection Circuit

The simplest device for output voltage regulation, over-voltage and over-current protection is a linear voltage regulator with overheat protection that is connected to the input or output end in series (Figure 2).

### ⑤ No parallel connection or plug and play.

## TYPICAL CHARACTERISTICS

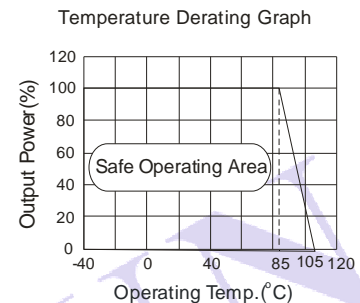
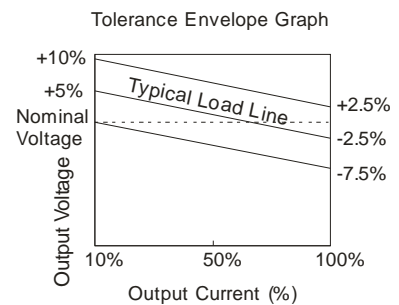

## RECOMMENDED CIRCUIT

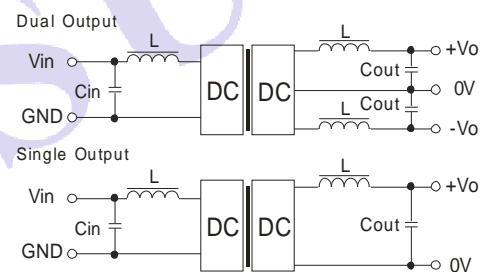

(Figure 1)

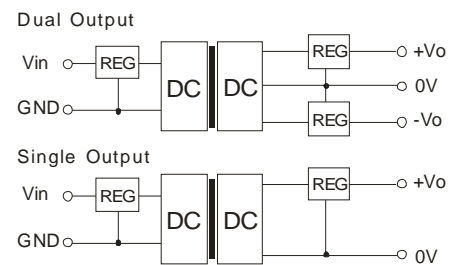

(Figure 2)

### Recommended capacitance (Table 1)

Vin (VDC)	Cin (μF)	Single output (VDC)	Cout (μF)	Dual output (VDC)	Cout (μF)
5	4.7	5	10	±5	4.7
12	2.2	9	4.7	±9	2.2
15	2.2	12	2.2	±12	1
24	1	15	1	±15	0.47

1. The recommended external capacitance please use the ceramic capacitor;
2. For applications where output power is less than 0.5W in reality, external capacitors are not recommended.

# OUTLINE DIMENSIONS & PIN CONNECTIONS

## MECHANICAL DIMENSIONS

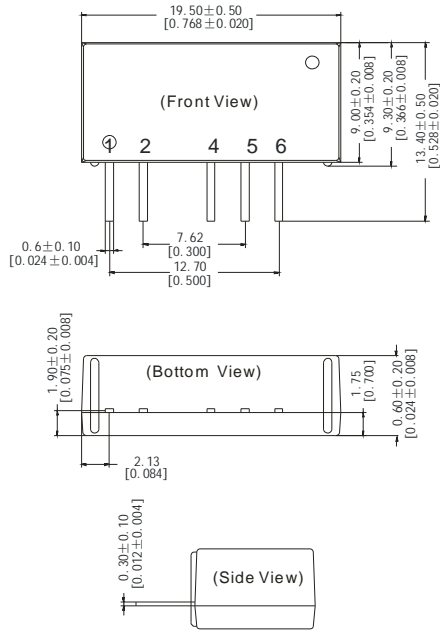

FOOTPRINT DETAILS		
PIN	Dual	Single
1	Vin	Vin
2	GND	GND
4	-Vo	0V
5	0V	No Pin
6	+Vo	+Vo

Note:  
 Unit: mm[inch]  
 Pin section tolerances:  $\pm 0.10\text{mm}$  [ $\pm 0.004\text{inch}$ ]  
 General tolerances:  $\pm 0.25\text{mm}$  [ $\pm 0.010\text{inch}$ ]

## RECOMMENDED FOOTPRINT

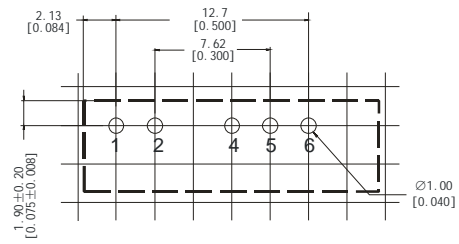

Note: grid 2.54\*2.54mm.

## TUBE OUTLINE DIMENSIONS

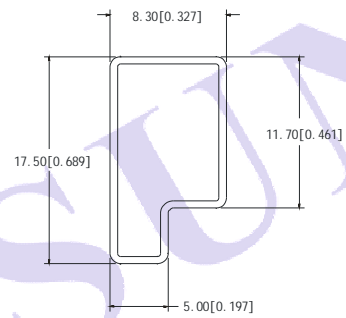

Note:  
 Unit: mm[inch]  
 General tolerances:  $\pm 0.50\text{mm}$  [ $\pm 0.020\text{inch}$ ]  
 L=530mm[20.866inch] Devices per tube quantity: 25pcs  
 L=220mm[8.661inch] Devices per tube quantity: 10pcs  
 Short tube inner package dimensions: 255\*170\*80mm  
 Short tube outer package dimensions  
 (with six inner package box): 375\*280\*270mm  
 Long tube inner package dimensions: 580\*200\*100mm  
 Long tube outer package dimensions  
 (with two inner package box): 600\*215\*220mm  
 Long tube outer package dimensions  
 (with three inner package box): 600\*215\*325mm

Note:

1. Operation under minimum load will not damage the converter; However, they may not meet all specification listed, and that will reduce the life of product.
2. All specifications measured at  $T_a=25^\circ\text{C}$ , humidity<75%, nominal input voltage and rated output load unless otherwise specified.
3. In this datasheet, all the test methods of indications are based on corporate standards.
4. Only typical models listed, other models may be different, please contact our technical person for more details.