



SY7208/SY7208B

High Efficiency 1MHz, 2A Step Up Regulator

General Description

The SY7208 and SY7208B are high efficiency boost regulators targeted for general step-up applications. SY7208B incorporates input over-voltage protection and turn off the regulator when the input voltage exceeds 7V.

Ordering Information

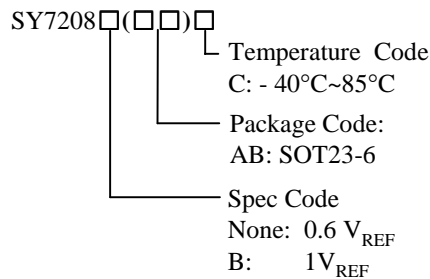

Features

- wide input range: 3-25V bias input, 25V_{out} max
- 1MHz switching frequency
- Minimum on time: 100ns typical
- Minimum off time: 100ns typical
- Low R_{dson}: 0.2ohm
- Programmable softstart: SY7208B
- 7V input OVP protection: SY7208B
- Accurate Reference:
 - o SY7208, 0.6V_{REF}
 - o SY7208B: 1V_{REF}
- Compact package: SOT23 6 pins

Applications

- WLED Drivers
- Networking cards powered from PCI or PCI-express slots

Typical Applications

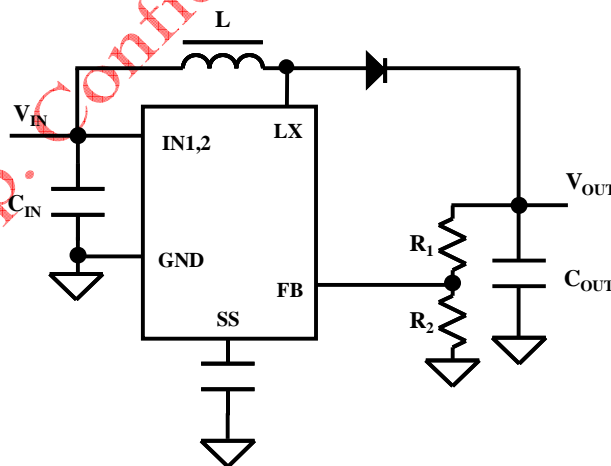
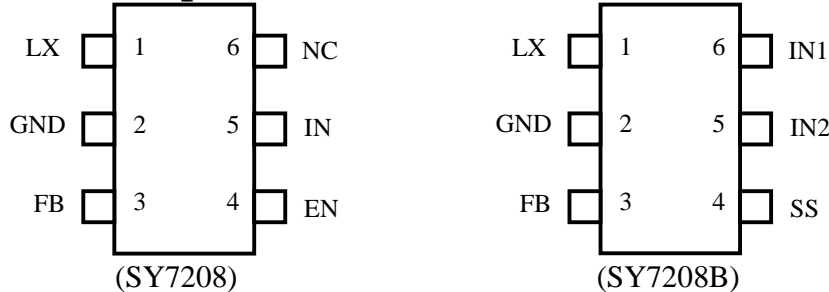

Fig. 1 Typical Schematic Diagram



SY7208/SY7208B

Pinout (SOT23-6 top view)



Top Mark: CAxyz for SY7208 BLxyz for sy7208B

(Device code: CA for SY7208 and BL for SY7208B, x=year code, y=week code, z=Wafer lot number code)

Pin Name	SOT23-6	Pin Description
IN(SY7208)	5	Input pin. Decouple this pin to GND pin with 1uF ceramic cap.
IN1,2(SY7208B)	6,5	Input pins. Decouple this pin to GND pin with 1uF ceramic cap.
GND	2	Ground pin
LX	1	Inductor node. Connect an inductor between IN pin and LX pin.
FB	3	Feedback pin. Connect a resistor R1 between V _{OUT} and FB, and a resistor R2 between FB and GND to program the output voltage: V _{OUT} =0.6V*(R1/R2+1)—SY7208; V _{OUT} =1V*(R1/R2+1)—SY7208B.
SS (SY7208B)	4	External softstart pin. Add a capacitor to this pin to program the softstart time to limit the inrush current. For SY7208B, pull this pin to IN can disable the input OVP.
EN (SY7208)	4	Enable control. High to turn on the part. Don't leave it floated.

Absolute Maximum Ratings (Note 1)

OUT, LX, IN, SEN	26V
All other pins	6V
Power Dissipation, P _D @ T _A = 25°C SOT-23-6,	0.4W
Package Thermal Resistance (Note 2)	
θ _{JA}	250°C/W
θ _{JC}	130°C/W
Junction Temperature Range	150°C
Lead Temperature (Soldering, 10 sec.)	260°C
Storage Temperature Range	-65°C to 150°C
ESD Susceptibility (Note 2)	
HBM (Human Body Mode)	2kV
MM (Machine Mode)	200V

Recommended Operating Conditions (Note 3)

IN1,2, LX	3V to 25V
All other pins	0-5.5V
Junction Temperature Range	-40°C to 125°C
Ambient Temperature Range	-40°C to 85°C



Electrical Characteristics

($V_{IN} = 5V$, $V_{out} = 12V$, $I_{out} = 100mA$, $T_A = 25^\circ C$ unless otherwise specified)

Parameter	Symbol	Test Conditions	Min	Typ	Max	Unit
Input Voltage Range	V_{IN}		3		25	V
Quiescent Current	I_Q	FB=0.66V		100		μA
Low Side Main FET RON	$R_{DS(ON)1}$			200		m Ω
Main FET Current Limit	I_{LIM1}		2		2.6	A
Switching Frequency	F_{SW}		0.8	1	1.2	MHz
Feedback Reference Voltage	V_{REF}	SY7208	0.588	0.6	0.612	V
		SY7208B	0.98	1	1.02	V
IN OVP rising threshold	$V_{IN,OV}$	SY7208B only	7			V
IN OVP hysteresis	$V_{OV,HYS}$	SY7208B only		0.3		V
IN UVLO rising threshold	$V_{IN,UVLO}$				2.7	V
UVLO hysteresis	$UVLO,HYS$			0.1		V
Thermal Shutdown Temperature	T_{SD}			150		$^\circ C$

Note 1: Stresses listed as the above “Absolute Maximum Ratings” may cause permanent damage to the device. These are for stress ratings. Functional operation of the device at these or any other conditions beyond those indicated in the operational sections of the specifications is not implied. Exposure to absolute maximum rating conditions for extended periods may remain possibility to affect device reliability.

Note 2: θ_{JA} is measured in the natural convection at $T_A = 25^\circ C$ on a low effective single layer thermal conductivity test board of JEDEC 51-3 thermal measurement standard.

Note 3: The device is not guaranteed to function outside its operating conditions.

SOT23-6 Package outline & PCB layout design

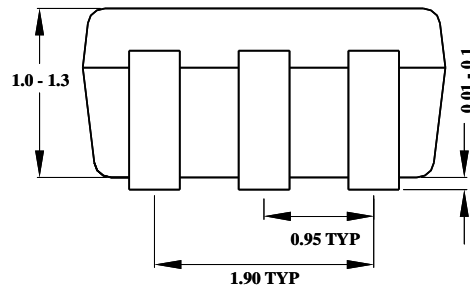
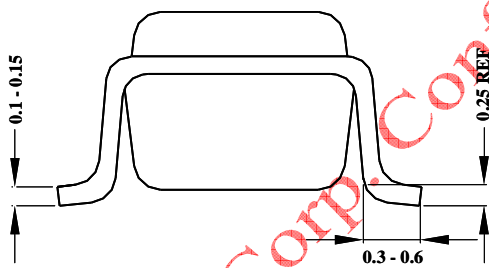
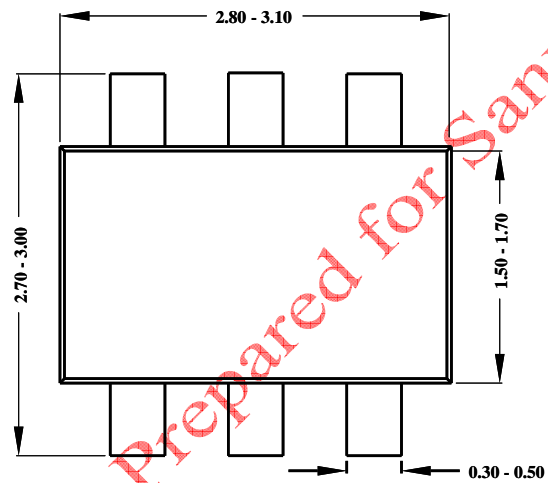
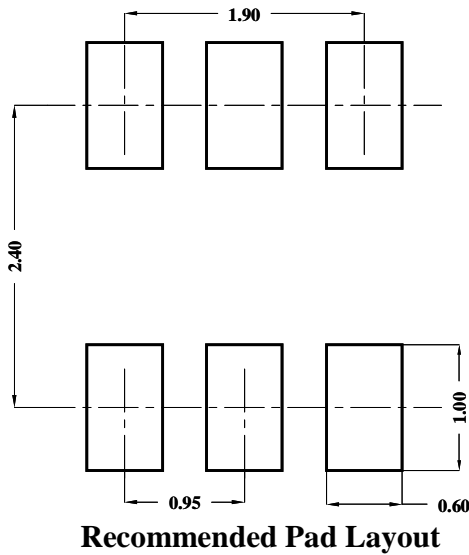

**Notes: All dimensions are in millimeters.
All dimensions don't include mold flash & metal burr.**