

RoHS Compliant Product
 A suffix of "-C" specifies halogen and lead-free

DESCRIPTION

The N-Channel MOSFET is used an advanced termination scheme to provide enhanced voltage-blocking capability without degrading performance over time. This advanced technology has been especially tailored to minimize on-state resistance, provide superior switching performance. This device is well suited for high efficiency switched mode power suppliers, active power factor correction, electronic lamp ballasts based half bridge topology.

FEATURES

- Robust high voltage termination
- Avalanche energy specified
- Diode is characterized for use in bridge circuits
- Source to Drain diode recovery time comparable to a discrete fast recovery diode.

TO-220Y

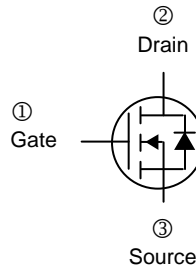
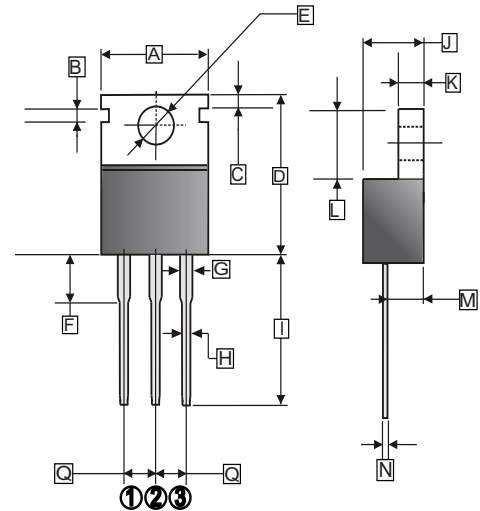

REF.	Millimeter		REF.	Millimeter	
	Min.	Max.		Min.	Max.
A	-	10.6	I	12.70	14.70
B	1.58	1.82	J	3.60	4.80
C	1.20	1.45	K	1.14	1.40
D	14.22	16.50	L	5.84	6.86
E	3.50	4.00	M	2.03	2.90
F	2.70	3.30	N	0.35	0.64
G	1.20	1.78	Q	2.34	2.74
H	0.50	1.00			

ABSOLUTE MAXIMUM RATINGS ($T_c=25^\circ\text{C}$ unless otherwise specified)

Parameter	Symbol	Ratings	Unit
Drain-Source Voltage	V_{DS}	600	V
Gate-Source Voltage	V_{GS}	± 30	V
Continuous Drain Current	I_D	4.1	A
Pulsed Drain Current	I_{DM}	16.4	A
Power Dissipation ²	P_D	98	W
Derating factor above 25°C		0.78	W / °C
Single Pulsed Avalanche Energy ¹	E_{AS}	262	mJ
Repetitive Avalanche Energy ²	E_{AR}	3.9	mJ
Operating Junction and Storage Temperature Range	T_J, T_{stg}	150, -55 ~ 150	°C
Thermal Resistance Rating			
Maximum Junction to Ambient ¹	$R_{\theta JA}$	62.5	°C / W
Maximum Junction to Case	$R_{\theta JC}$	1.28	

Notes:

1. $L=26\text{mH}$, $I_{AS}=4.1\text{A}$, $V_{DD}=50\text{V}$, $R_G=50\Omega$, Starting $T_J=25^\circ\text{C}$
2. Repetitive Rating: Pulse width limited by maximum junction temperature.

ELECTRICAL CHARACTERISTICS ($T_A = 25^\circ\text{C}$ unless otherwise specified)

Parameter	Symbol	Min.	Typ.	Max.	Unit	Test Conditions
Gate-Threshold Voltage	$V_{GS(th)}$	2	-	4	V	$V_{DS}=V_{GS}$, $I_D=250\mu\text{A}$
Drain-Source On-Resistance	$R_{DS(ON)}$	-	2.0	2.5	Ω	$V_{GS}=10\text{V}$, $I_D=2.05\text{A}$
Drain-Source Breakdown Voltage	BV_{DSS}	600	-	-	V	$V_{GS}=0$, $I_D=250\mu\text{A}$
Zero Gate Voltage Drain Current	I_{DSS}	-	-	10	μA	$V_{DS}=600\text{V}$, $V_{GS}=0$
Gate-Body Leakage Current, Forward	I_{GSSF}	-	-	100	nA	$V_{GS}=30\text{V}$, $V_{DS}=0$
Gate-Body Leakage Current, Reverse	I_{GSSR}	-	-	-100	nA	$V_{GS}=-30\text{V}$, $V_{DS}=0$
Dynamic						
Total Gate Charge ^{1,2}	Q_g	-	19	-	nC	$V_{DS}=480\text{V}$, $I_D=4.1\text{A}$, $V_{GS}=10\text{V}$
Gate-Source Charge ^{1,2}	Q_{gs}	-	2.9	-		
Gate-Drain Charge ^{1,2}	Q_{gd}	-	8.2	-		
Turn-on Delay Time ^{1,2}	$T_{d(on)}$	-	25	-	nS	$V_{DD}=300\text{V}$, $I_D=4.1\text{A}$, $R_G=25\Omega$
Rise Time ^{1,2}	T_r	-	54	-		
Turn-off Delay Time ^{1,2}	$T_{d(off)}$	-	120	-		
Fall Time ^{1,2}	T_f	-	34	-		
Input Capacitance	C_{iss}	-	570	-	pF	$V_{DS}=25\text{V}$, $V_{GS}=0$, $f=1.0\text{MHz}$
Output Capacitance	C_{oss}	-	64	-		
Reverse Transfer Capacitance	C_{rss}	-	14	-		
Maximum Continuous Drain-Source Diode Forward Current	I_S	-	-	4.1	A	
Maximum Pulsed Drain-Source Diode Forward Current	I_{SM}	-	-	16.4	A	
Drain-Source Diode Forward Voltage	V_{SD}	-	-	1.4	V	$V_{GS}=0$, $I_S=4\text{A}$
Reverse Recovery Time ¹	T_{rr}	-	560	-	nS	$V_{GS}=0$, $I_S=4.1\text{A}$,
Reverse Recovery Charge ¹	Q_{rr}	-	1.78	-	μC	$di_F / dt = 100\text{A} / \mu\text{s}$

Notes:

1. Pulse Test: Pulse width < 300us, Duty cycle \leq 2%.
2. Basically not affected by working temperature.

CHARACTERISTIC CURVE

Fig 1. On-State Characteristics

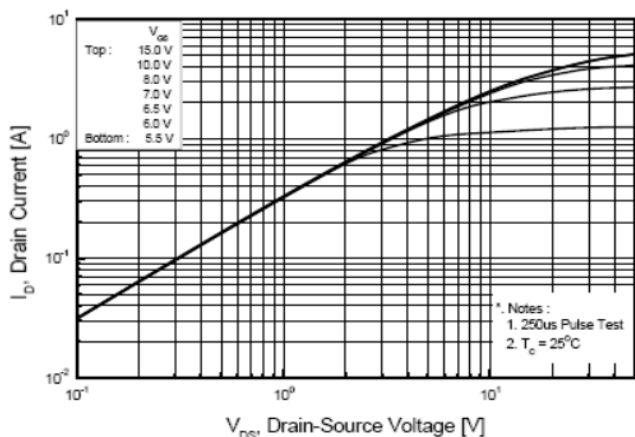

Fig 2. Transfer Characteristics

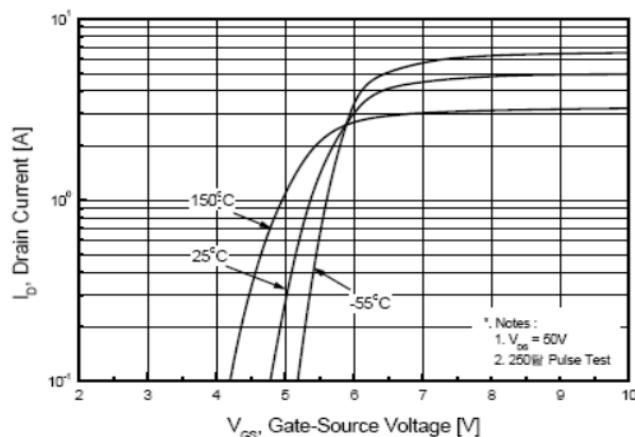

Fig 3. On Resistance Variation vs. Drain Current and Gate Voltage

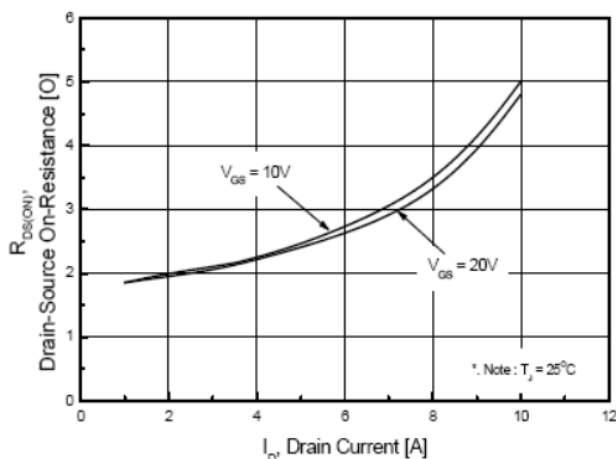

Fig 4. On State Current vs. Allowable Case Temperature

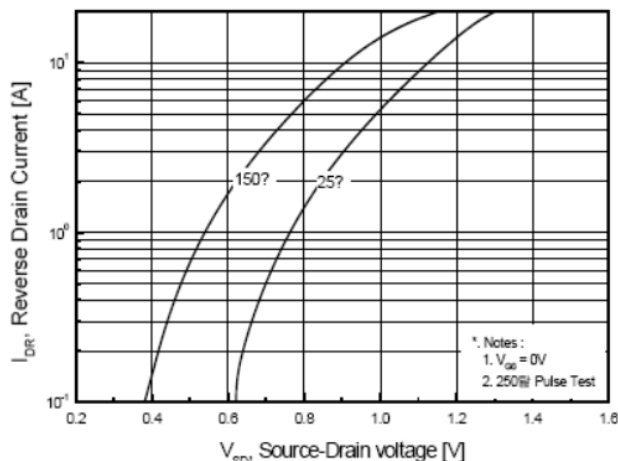

Fig 5. Capacitance Characteristics (Non-Repetitive)

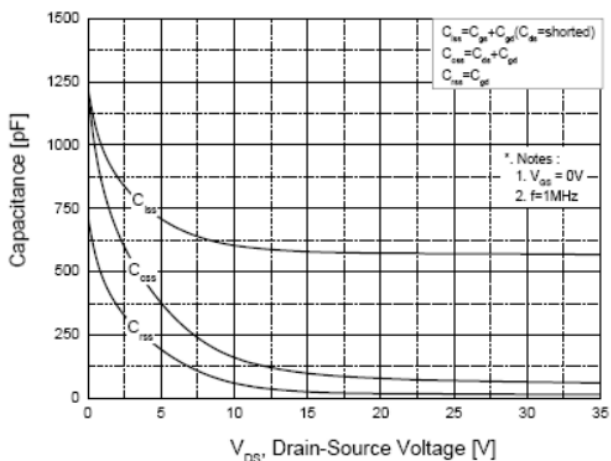
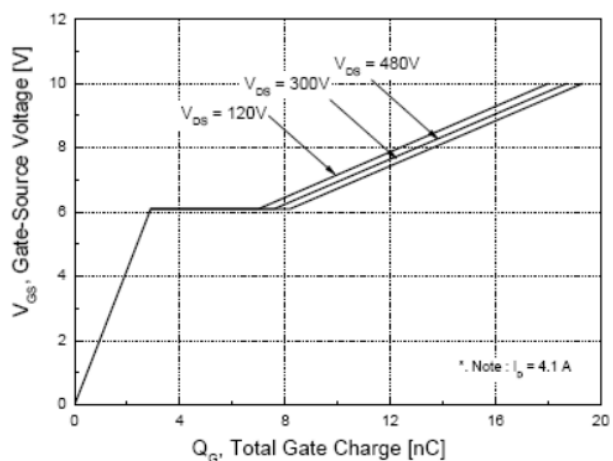

Fig 6. Gate Charge Characteristics



CHARACTERISTIC CURVE

Fig 7. Breakdown Voltage Variation vs. Junction Temperature

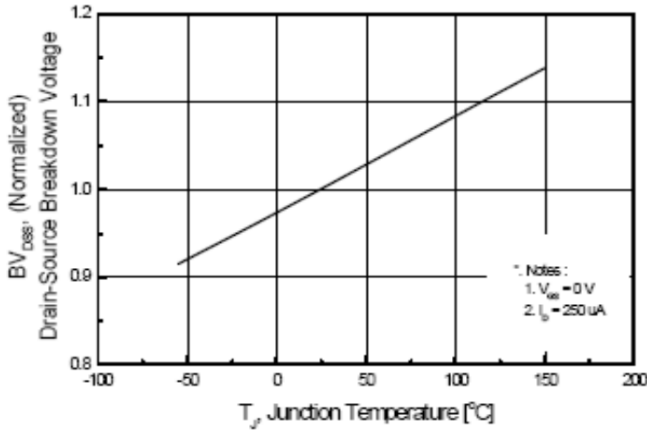

Fig 8. On-Resistance Variation vs. Junction Temperature

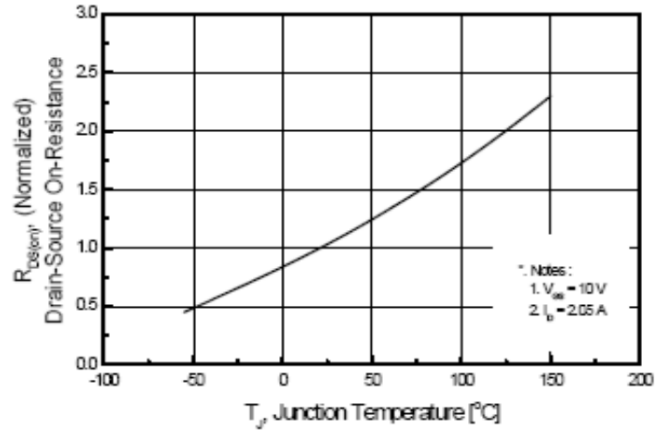

Fig 9. Maximum Safe Operating Area (TO-220)

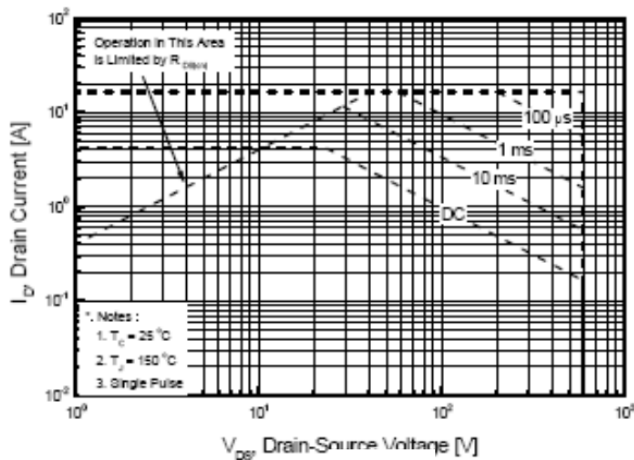

Fig 10. Maximum Drain Current vs. Case Temperature. (TO220)

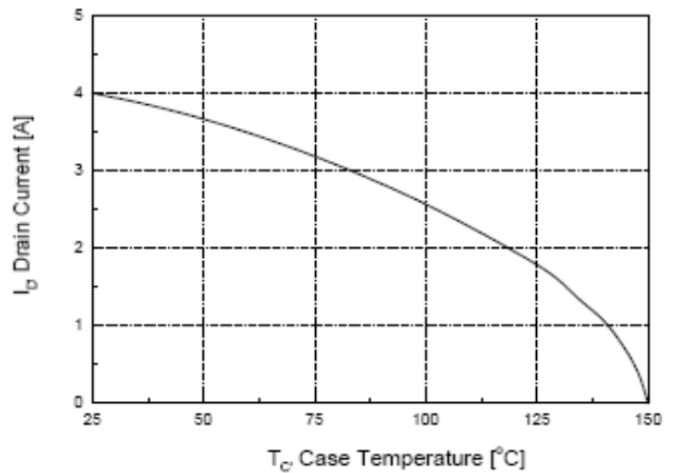
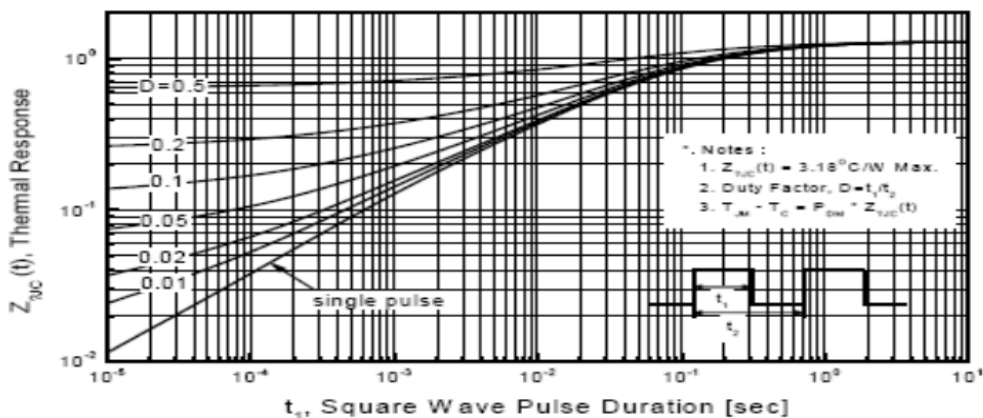

Fig 11. Transient Thermal Response Curve(TO220)



CHARACTERISTIC CURVE

Fig. 12. Gate Charge Test Circuit & Waveforms

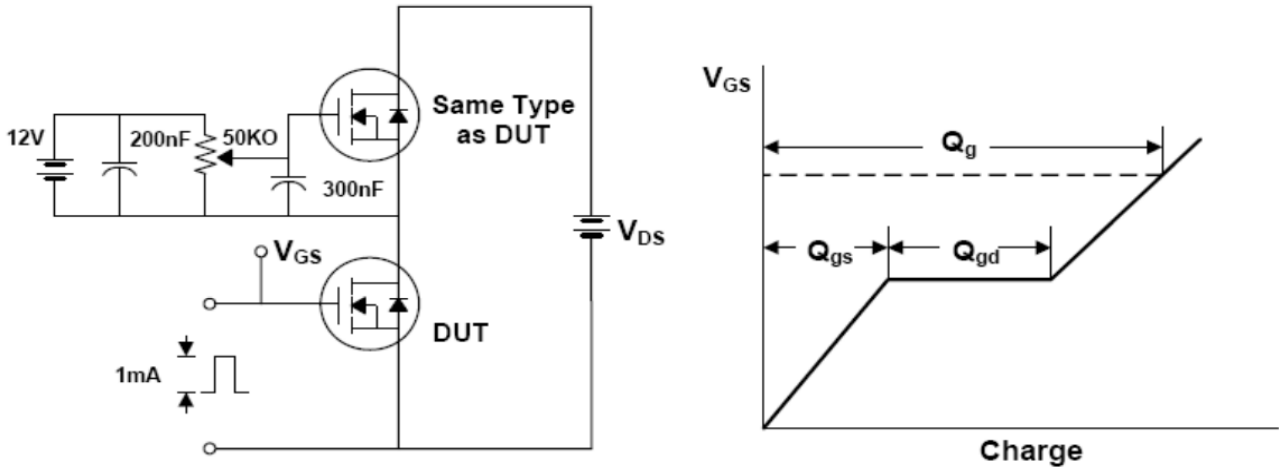

Fig 13. Switching Time Test Circuit & Waveforms

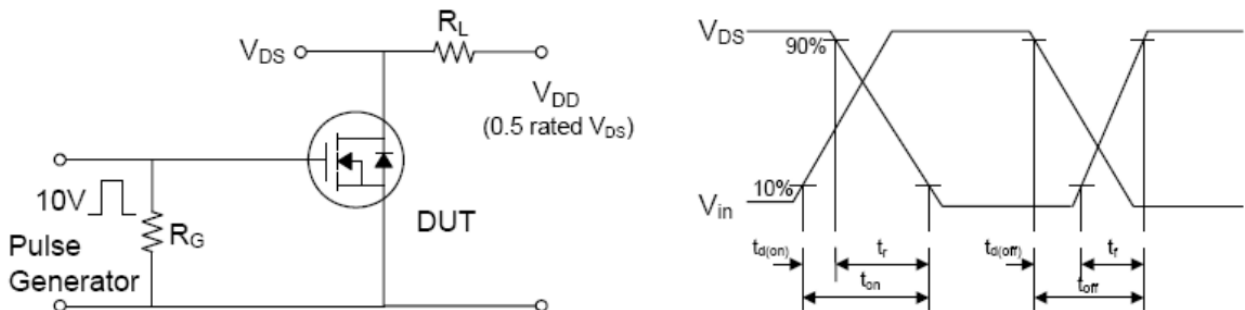
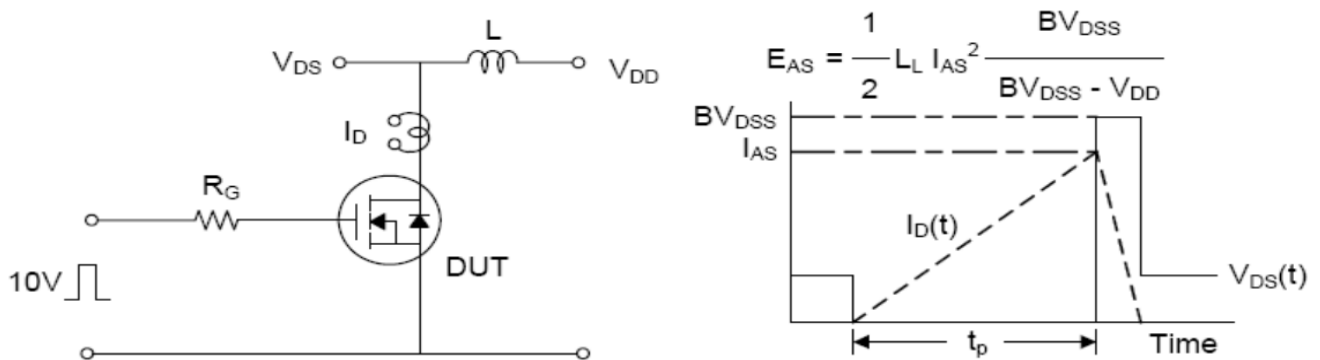

Fig 14. Unclamped Inductive Switching Test Circuit & Waveforms



CHARACTERISTIC CURVE

Fig. 15. Peak Diode Recovery dv/dt Test Circuit & Waveforms

