

# Silicon P-N-P Transistors

Complementary to the D44VH Series

**Features:**

- Fast Switching  $t_s \leq 500 \text{ ns}$  resistive  
 $t_f \leq 100 \text{ ns}$
- Low  $V_{CE(sat)} \leq 1.0V$  @  $I_C = 8A$

The D45VH-series of silicon p-n-p power transistors are especially designed for use in switching circuits such as switching regulators, high-frequency inverters/converters, and other applications where very fast switching times and low-saturation voltages are necessary. These devices are tested for parameters that relate directly to the design of high-power switching circuits. Switching times, saturation voltages, and leakage currents are specified at 100°C to provide information necessary for worst-case design.

**TERMINAL DESIGNATIONS**

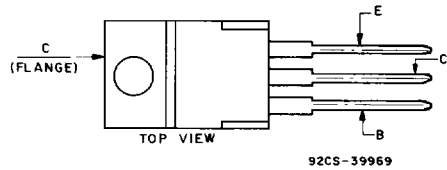

JEDEC TO-220AB

**POWER TRANSISTORS 2**

**MAXIMUM RATINGS (T<sub>A</sub> = 25° C)** (unless otherwise specified)

RATING	SYMBOL	D45VH1	D45VH4	D45VH7	D45VH10	UNITS
Collector-Emitter Voltage	V <sub>CEO(sus)</sub>	-30	-45	-60	-80	Volts
Collector-Emitter Voltage	V <sub>CEx</sub>	-40	-55	-70	-90	Volts
Collector-Emitter Voltage	V <sub>CEV</sub>	-50	-70	-80	-100	Volts
Emitter Base Voltage	V <sub>EB0</sub>	-7	-7	-7	-7	Volts
Collector Current — Continuous	I <sub>C</sub>	-15	-15	-15	-15	A
Peak <sup>(1)</sup>	I <sub>CM</sub>	-20	-20	-20	-20	
Base Current — Continuous	I <sub>B</sub>	-5	-5	-5	-5	A
Peak <sup>(1)</sup>	I <sub>BM</sub>	-10	-10	-10	-10	
Total Power Dissipation @ T <sub>c</sub> = 25° C	P <sub>D</sub>	83	83	83	83	Watts
@ T <sub>c</sub> = 100° C		33	33	33	33	
Derate above 25° C		0.67	0.67	0.67	0.67	W/° C
Operating and Storage Junction Temperature Range	T <sub>J</sub> , T <sub>STG</sub>	-55 to +150	-55 to +150	-55 to +150	-55 to +150	° C

**THERMAL CHARACTERISTICS**

Thermal Resistance, Junction to Case	R <sub>θJC</sub>	1.5	1.5	1.5	1.5	° C/W
Thermal Resistance, Junction to Ambient	R <sub>θJA</sub>	75	75	75	75	° C/W
Maximum Lead Temperature for Soldering Purpose: 1/8" from Case for 5 Seconds	T <sub>L</sub>	235	235	235	235	° C

(1) Pulse measurement condition PW ≤ 6.0 ms, see Figure 14.

# D45VH Series

## ELECTRICAL CHARACTERISTICS (T<sub>C</sub> = 25°C) (unless otherwise specified)

CHARACTERISTICS	SYMBOL	MIN	MAX	UNIT
-----------------	--------	-----	-----	------

### OFF CHARACTERISTICS<sup>(1)</sup>

Collector-Emitter Sustaining Voltage <sup>(1)</sup> (I <sub>C</sub> = -100mA, I <sub>B</sub> = 0) D45VH1 D45VH4 D45VH7 D45VH10	V <sub>CEO(sus)</sub>	-30 -45 -60 -80	— — — —	V
Collector-Emitter Voltage <sup>(2)</sup> (I <sub>C</sub> = -10A, V <sub>CLAMP</sub> = Rated V <sub>CEX</sub> , T <sub>C</sub> = 100°C) D45VH1 D45VH4 D45VH7 D45VH10	V <sub>CEX</sub>	-40 -55 -70 -90	— — — —	V
Collector Cutoff Current (V <sub>CEV</sub> = Rated Value, V <sub>BE(off)</sub> = 4.0V) (V <sub>CEV</sub> = Rated Value, V <sub>BE(off)</sub> = 4.0V, T <sub>C</sub> = 100°C)	I <sub>CEV</sub>	— —	-10 -100	μA
Collector Cutoff Current (V <sub>CE</sub> = Rated V <sub>CEV</sub> , R <sub>BE</sub> = 50 Ω, T <sub>C</sub> = 100°C)	I <sub>CER</sub>	—	-100	μA
Emitter Cutoff Current (V <sub>EB</sub> = -7V, I <sub>C</sub> = 0)	I <sub>EBO</sub>	—	-10	μA

### SECOND BREAKDOWN

Second Breakdown with Base Forward Biased	F <sub>BSOA</sub>	SEE FIGURE 7
Second Breakdown with Base Reverse Biased	R <sub>BSOA</sub>	SEE FIGURE 8

### ON CHARACTERISTICS<sup>(1)</sup>

DC Current Gain (I <sub>C</sub> = -2 A, V <sub>CE</sub> = -1V) (I <sub>C</sub> = -4 A, V <sub>CE</sub> = -1V)	h <sub>FE</sub>	35 20	— —	—
Collector-Emitter Saturation Voltage (I <sub>C</sub> = -8A, I <sub>B</sub> = -0.8A) (I <sub>C</sub> = -8A, I <sub>B</sub> = -0.8A, T <sub>C</sub> = 100°C) (I <sub>C</sub> = -15A, I <sub>B</sub> = -3.0A, T <sub>C</sub> = 100°C)	V <sub>CE(sat)</sub>	— — —	-1.0 -1.1 -1.5	V
Base-Emitter Saturation Voltage (I <sub>C</sub> = -8A, I <sub>B</sub> = -0.8A) (I <sub>C</sub> = -8A, I <sub>B</sub> = -0.8A, T <sub>C</sub> = 100°C)	V <sub>BE(sat)</sub>	— —	-1.4 -1.4	V

### DYNAMIC CHARACTERISTICS

Typical

Current-Gain — Bandwidth Product (I <sub>C</sub> = -0.1A, V <sub>CE</sub> = -10V, f <sub>test</sub> = 1 MHz)	f <sub>T</sub>	50	MHz
Output Capacitance (V <sub>CB</sub> = -10V, I <sub>E</sub> = 0, f <sub>test</sub> = 1 MHz)	C <sub>OB</sub>	275	pF

### SWITCHING CHARACTERISTICS

Maximum

Resistive Load (See Figure 16 for Test Circuit)		T <sub>C</sub>	25°C	100°C	
Delay Time	V <sub>CC</sub> = -20V, I <sub>C</sub> = -8A I <sub>B1</sub> = I <sub>B2</sub> = 0.8A t <sub>p</sub> = 25 μsec	t <sub>d</sub>	50	—	nsec
Rise Time		t <sub>r</sub>	250	—	nsec
Storage Time		t <sub>s</sub>	500	—	nsec
Fall Time		t <sub>f</sub>	100	—	nsec
Inductive Load, Clamped (See Figure 15 for Test Circuit)					
Storage Time	V <sub>CC</sub> = -20V, I <sub>C</sub> = -8A V <sub>CLAMP</sub> = Rated V <sub>CEX</sub> I <sub>B1</sub> = -0.8A, V <sub>BE(off)</sub> = 5V	t <sub>s</sub>	500	600	nsec
Fall Time		t <sub>f</sub>	300	400	nsec
			<b>Typical</b>		
Storage Time	L = 200 μh	t <sub>s</sub>	200	320	nsec
Fall Time		t <sub>f</sub>	160	180	nsec

(1) Pulse Duration = 300 μsec, Duty Factor ≤ 2%.

(2) See Figure 15 for Test Circuit.

TYPICAL DC CHARACTERISTICS

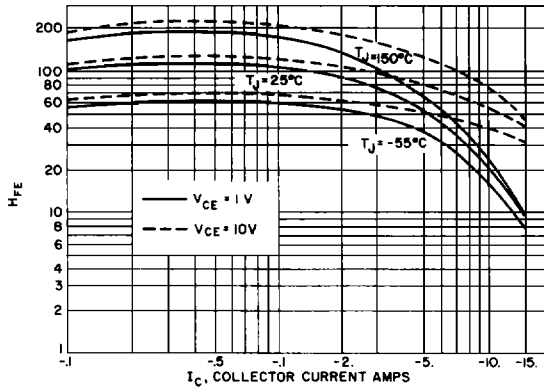

1. DC CURRENT GAIN

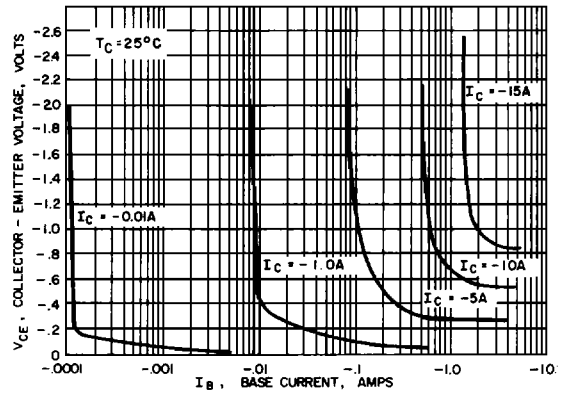

2. COLLECTOR SATURATION REGION

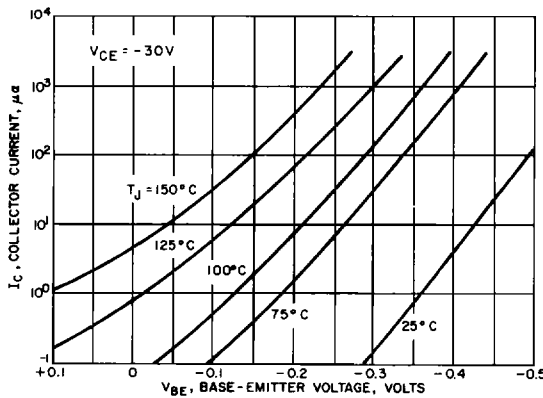

3. COLLECTOR CUTOFF REGION

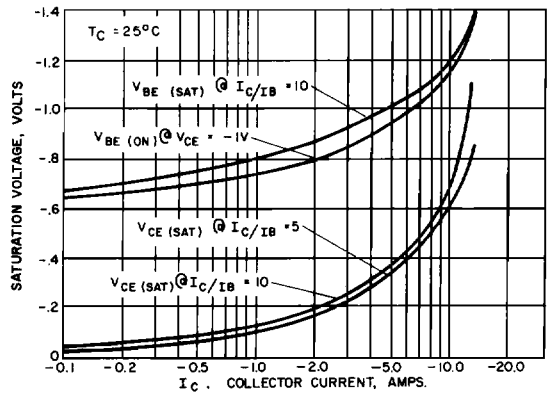

4. SATURATION VOLTAGE

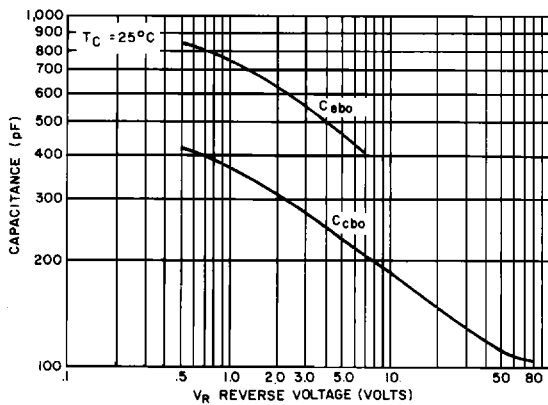

5. CAPACITANCE

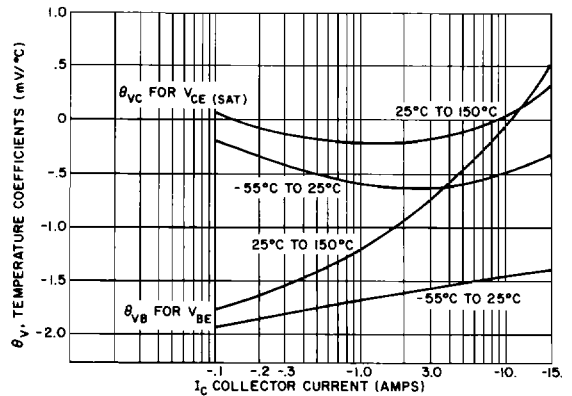

6. SATURATION VOLTAGE TEMPERATURE COEFFICIENTS

2  
POWER TRANSISTORS

# D45VH Series

## SAFE OPERATING AREA

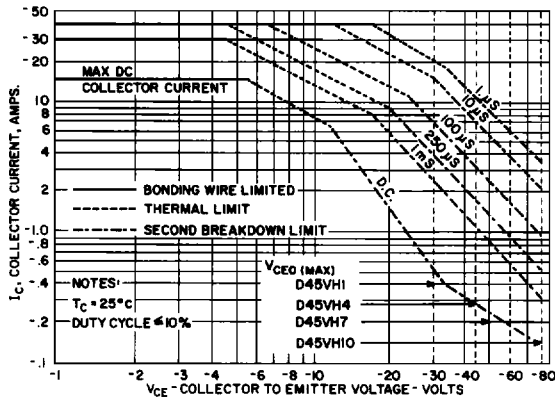

7. FORWARD BIAS SOA

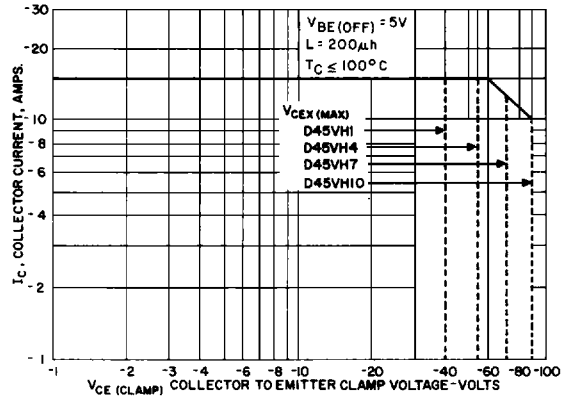

8. REVERSE BIAS SOA

## TYPICAL SWITCHING CHARACTERISTICS

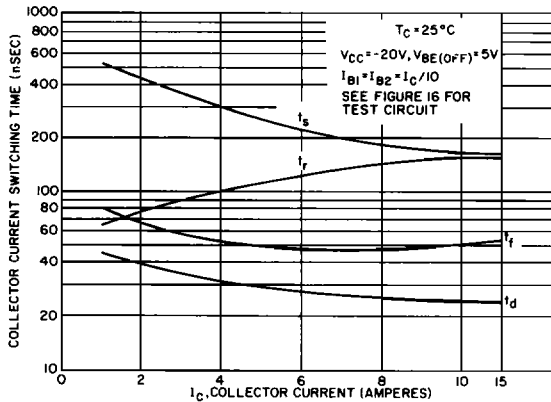

9. RESISTIVE SWITCHING TIME

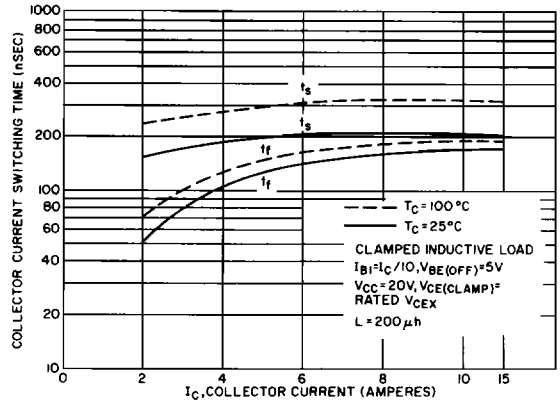

10. CLAMPED INDUCTIVE SWITCHING TIME

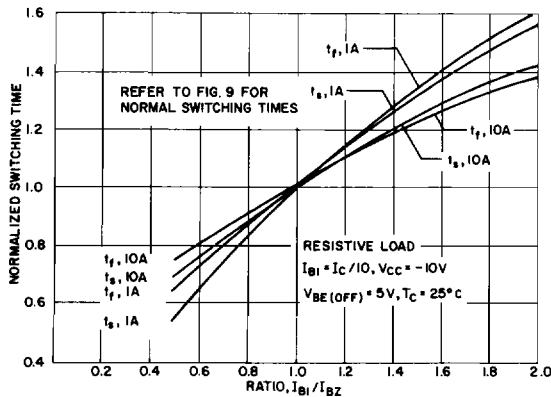

11. SWITCHING TIME VARIATION WITH  $I_{B2}$

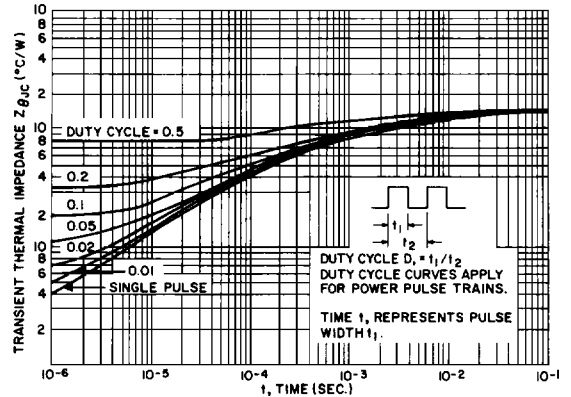

12. TRANSIENT THERMAL RESPONSE

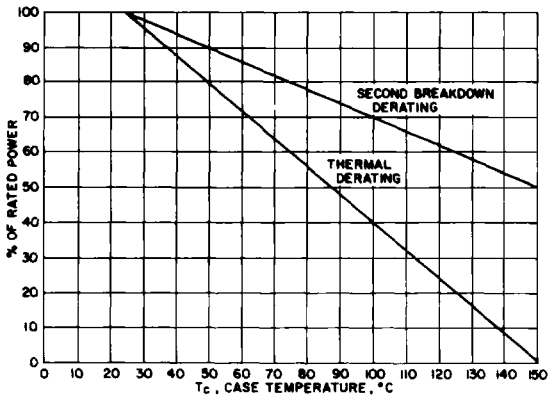

13. POWER DERATING FACTOR

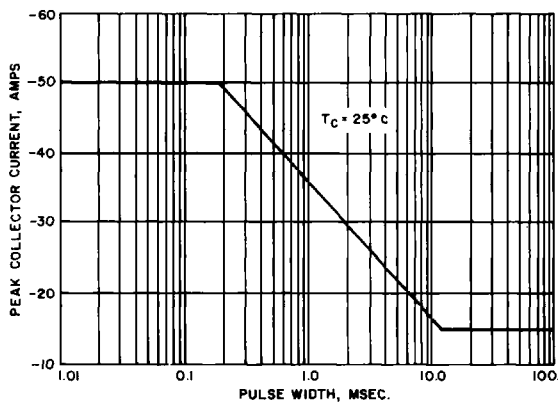

14. MAXIMUM SINGLE PULSE COLLECTOR CURRENT

2  
POWER TRANSISTORS

TEST CIRCUITS

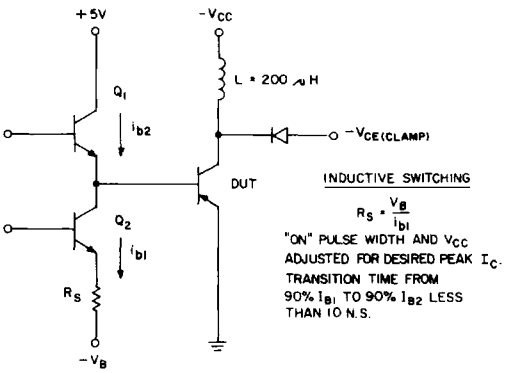

15. INDUCTIVE SWITCHING AND  $V_{CEX}$

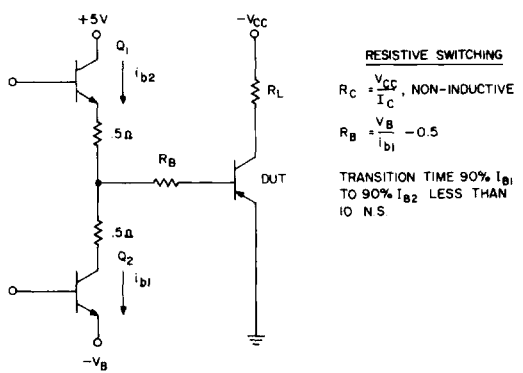

16. RESISTIVE SWITCHING