

RUE Selection Guide and Product Data

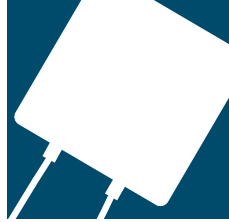

This section has two parts:

- **A Selection Guide that walks you through the process of selecting the correct RUE device for a circuit.**
- **Product Data that outlines electrical characteristics, physical characteristics, agency recognitions, environmental specifications, component layouts, tape and reel specifications, and ordering information for RUE devices.**

RUE Selection Guide

Follow these seven steps to select a PolySwitch RUE device for a circuit:

1. Define the operating parameters for the circuit.
These include:
 - Maximum ambient operating temperature
 - Normal operating current
 - Maximum operating voltage (RUE is 30 V maximum)
 - Maximum interrupt current
2. Select the RUE device that accommodates the circuit's maximum ambient operating temperature and normal operating current.
3. Compare the RUE device's maximum operating voltage and maximum interrupt current with the circuit's to be sure the circuit does not exceed the device ratings.
4. Check the RUE device's time-to-trip to be sure it will protect the circuit.
5. Verify that the circuit's ambient operating temperatures are within the RUE device's operating temperature range.
6. Verify that the RUE device's dimensions fit the application's space considerations.
7. Independently evaluate and test the suitability and performance of the RUE device in the application.

4



1. Define the circuit's operating parameters.

Fill in the following information about the circuit:

Maximum ambient operating temperature _____

Normal operating current _____

Maximum operating voltage (RUE is 30 V max.) _____

Maximum interrupt current _____

2. Select the PolySwitch RUE device that will accommodate the circuit's maximum ambient operating temperature and normal operating current.

Look across the top of the table below to find the temperature that most closely matches the circuit's maximum ambient operating temperature. Look down that column to find the value equal to or greater than the circuit's normal operating current. Now look to the far left of that row to find the part number for the RUE device that will best accommodate the circuit.

The thermal derating curve located on the next page is a normalized representation of the data in the table below.

I_{Hold} vs. temperature

Part number	Maximum ambient operating temperatures (°C)								
	-40°	-20°	0°	20°	40°	50°	60°	70°	85°
RUE090	1.31	1.17	1.04	0.90	0.75	0.69	0.61	0.55	0.47
RUE110	1.60	1.43	1.27	1.10	0.91	0.85	0.75	0.67	0.57
RUE135	1.96	1.76	1.55	1.35	1.12	1.04	0.92	0.82	0.70
RUE160	2.32	2.08	1.84	1.60	1.33	1.23	1.09	0.98	0.83
RUE185	2.68	2.41	2.13	1.85	1.54	1.42	1.26	1.13	0.96
RUE250	3.63	3.25	2.88	2.50	2.08	1.93	1.70	1.53	1.30
RUE300	4.35	3.90	3.45	3.00	2.49	2.31	2.04	1.83	1.56
RUE400	5.80	5.20	4.60	4.00	3.32	3.08	2.72	2.44	2.08
RUE500	7.25	6.50	5.75	5.00	4.15	3.85	3.40	3.05	2.60
RUE600	8.70	7.80	6.90	6.00	4.98	4.62	4.08	3.66	3.12
RUE700	10.15	9.10	8.05	7.00	5.81	5.39	4.76	4.27	3.64
RUE800	11.60	10.40	9.20	8.00	6.64	6.16	5.44	4.88	4.16
RUE900	13.05	11.70	10.35	9.00	7.47	6.93	6.12	5.49	4.68

Thermal derating curve

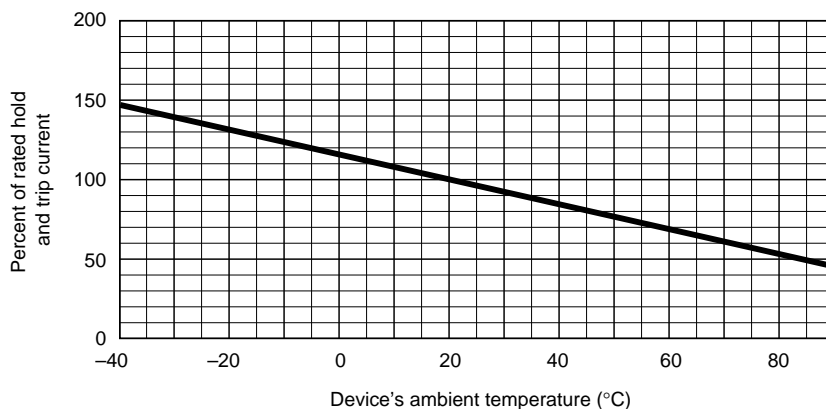

3. Compare maximum operating voltages and maximum interrupt currents.

Look down the first column of the table below to find the part number you selected in Step 1. Look to the right in that row to find the device's maximum operating voltage (V max.) and maximum interrupt current (I max.).

Compare both ratings with the circuit's to be sure the circuit's ratings do not exceed those of the RUE device.



Maximum device voltages and currents

Part number	V max. (volts)	I max. (amps)*
RUE090	30	40
RUE110	30	40
RUE135	30	40
RUE160	30	40
RUE185	30	40
RUE250	30	40
RUE300	30	40
RUE400	30	40
RUE500	30	40
RUE600	30	40
RUE700	30	40
RUE800	30	40
RUE900	30	40

*Device may withstand higher interrupt current at lower voltages. Each application will need to be individually qualified.

4. Determine time-to-trip.

Time-to-trip is the amount of time it takes for a device to switch to a high-resistance state once a fault current has been applied across the device.

Identifying the RUE device's time-to-trip is important in order to provide the desired protection capabilities. If the device you choose trips too fast, undesired or nuisance tripping will occur. If the device trips too slowly, the components being protected may be damaged before the device switches to a high-resistance state.

The chart below shows the typical time-to-trip at 20°C for each PolySwitch RUE device. For example, the chart indicates that the typical time-to-trip for RUE110 at 8 A is 1 second.

On the chart below, find the typical time-to-trip for the RUE device you selected. If the RUE device's time-to-trip is too fast or too slow for the circuit, go back to Step 2 and choose an alternate device.

Typical time-to-trip at 20°C

4

- A = RUE090
- B = RUE110
- C = RUE135
- D = RUE160
- E = RUE185
- F = RUE250
- G = RUE300
- H = RUE400
- I = RUE500
- J = RUE600
- K = RUE700
- L = RUE800
- M = RUE900

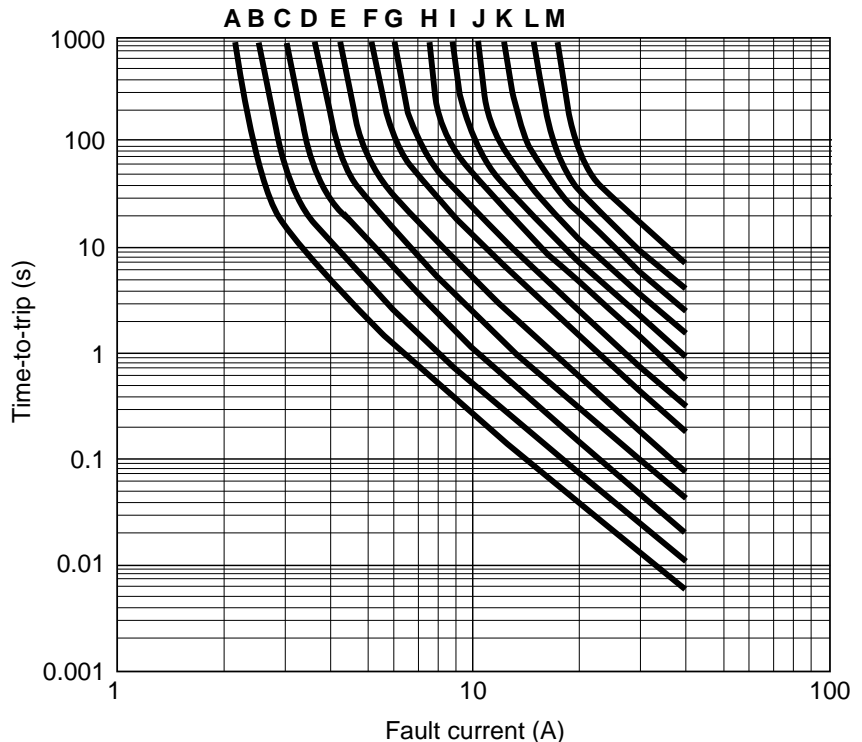

5. Verify ambient operating conditions.

Ensure that your application's minimum and maximum ambient temperatures are within the operating temperature range of -40°C and 85°C .

Maximum device surface temperature in the tripped state is 125°C .

6. Verify the RUE device's dimensions.

Using dimensions from the table below, compare the dimensions of the RUE device you selected with the application's space considerations.

Product dimensions (millimeters/inches)

Part number	A max.		B max.		C typ.		D min.		E max.		F typ.	
RUE090	7.4	(0.29)	12.2	(0.48)	5.1	(0.20)	7.6	(0.30)	3.0	(0.12)	0.8	(0.03)
RUE110	7.4	(0.29)	14.2	(0.56)	5.1	(0.20)	7.6	(0.30)	3.0	(0.12)	0.8	(0.03)
RUE135	8.9	(0.35)	13.5	(0.53)	5.1	(0.20)	7.6	(0.30)	3.0	(0.12)	0.8	(0.03)
RUE160	8.9	(0.35)	15.2	(0.60)	5.1	(0.20)	7.6	(0.30)	3.0	(0.12)	0.8	(0.03)
RUE185	10.2	(0.40)	15.7	(0.62)	5.1	(0.20)	7.6	(0.30)	3.0	(0.12)	0.8	(0.03)
RUE250	11.4	(0.45)	18.3	(0.72)	5.1	(0.20)	7.6	(0.30)	3.0	(0.12)	0.8	(0.03)
RUE300	11.4	(0.45)	17.3	(0.68)	5.1	(0.20)	7.6	(0.30)	3.0	(0.12)	1.2	(0.05)
RUE400	14.0	(0.55)	20.1	(0.79)	5.1	(0.20)	7.6	(0.30)	3.0	(0.12)	1.2	(0.05)
RUE500	14.0	(0.55)	24.9	(0.98)	10.2	(0.40)	7.6	(0.30)	3.0	(0.12)	1.2	(0.05)
RUE600	16.5	(0.65)	24.9	(0.98)	10.2	(0.40)	7.6	(0.30)	3.0	(0.12)	1.2	(0.05)
RUE700	19.1	(0.75)	26.7	(1.05)	10.2	(0.40)	7.6	(0.30)	3.0	(0.12)	1.2	(0.05)
RUE800	21.6	(0.85)	29.2	(1.15)	10.2	(0.40)	7.6	(0.30)	3.0	(0.12)	1.2	(0.05)
RUE900	24.1	(0.95)	29.7	(1.17)	10.2	(0.40)	7.6	(0.30)	3.0	(0.12)	1.2	(0.05)

4

Lead size

RUE090–RUE250 \varnothing 0.51
(0.020)
24 AWG

RUE300–RUE900 \varnothing 0.81
(0.032)
20 AWG

RUE090–RUE250*

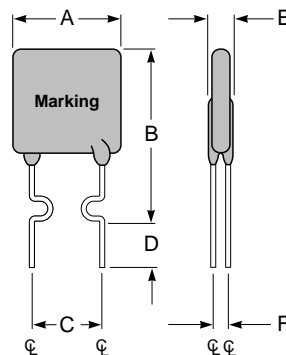

RUE300–RUE900**

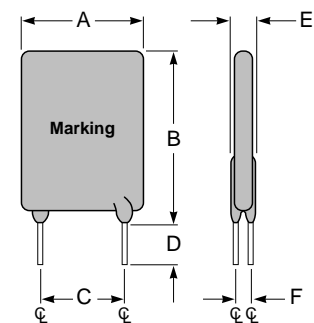

* Straight leads are available

** Kinked leads are available

RUE Product Data

Now that you have selected your RUE device, please review the device's characteristics in this section to verify that the device will perform as required.

Electrical characteristics (20°C)

Part Number	I _H (A)	I _T (A)	Max. time to trip (s) at 5 x I _H	P _d (W)	Initial resistance		Post-trip resistance
					R min. (Ω)	R max. (Ω)	R ₁ max. (Ω)
RUE090	0.90	1.80	5.9	0.6	0.070	0.12	0.22
RUE110	1.10	2.20	6.6	0.7	0.050	0.10	0.17
RUE135	1.35	2.70	7.3	0.8	0.040	0.08	0.13
RUE160	1.60	3.20	8.0	0.9	0.030	0.07	0.11
RUE185	1.85	3.70	8.7	1.0	0.030	0.06	0.09
RUE250	2.50	5.00	10.3	1.2	0.020	0.04	0.07
RUE300	3.00	6.00	10.8	2.0	0.020	0.05	0.08
RUE400	4.00	8.00	12.7	2.5	0.010	0.03	0.05
RUE500	5.00	10.00	14.5	3.0	0.010	0.03	0.05
RUE600	6.00	12.00	16.0	3.5	0.005	0.02	0.04
RUE700	7.00	14.00	17.5	3.8	0.005	0.02	0.03
RUE800	8.00	16.00	18.8	4.0	0.005	0.02	0.02
RUE900	9.00	18.00	20.0*	4.2	0.005	0.01	0.02

I_H = Hold current—maximum current at which the device will not trip at 20°C.

I_T = Trip current—minimum current at which the device will always trip at 20°C.

P_d = Typical power dissipation—typical amount of power dissipated by the device when in tripped state in 20°C still air.

R min. = Minimum device resistance at 20°C prior to tripping.

R max. = Maximum device resistance at 20°C prior to tripping.

R₁ max. = Maximum device resistance at 20°C measured 1 hour post trip.

* Device tested at 40 A.

Physical characteristics

Lead material	RUE090–250: Tin lead-plated copper-clad steel, 24 AWG, Ø 0.51 mm/0.020 in RUE300–900: Tin lead-plated copper, 20 AWG, Ø 0.81 mm/0.032 in
Soldering characteristics	Solderability per MIL-STD-202, Method 208E Solder heat withstand per MIL-STD-202, Method 210, Condition B
Insulating material	Cured, flame-retardant epoxy polymer; meets UL 94V-O requirements

Note: Devices are not designed to be placed through a reflow process.

Agency recognitions

UL	File # E74889
CSA	File # CA78165C
TÜV	Certificate # R9477318

Environmental specifications

Test	Test method	Conditions	Change resistance
Passive aging	Raychem PS300	70°C, 1000 hours	±5%
		85°C, 1000 hours	±5%
Humidity aging	Raychem PS300	85°C, 85% R.H., 1000 hours	±5%
Thermal shock	Raychem PS300	125°C, -55°C (10 times)	±5%
Solvent resistance	Raychem PS300, Method 215	MIL-STD-202, Method 215F	No change

Component layouts

The dimensions in the table below provide the component layout for each RUE device.



Component layout dimensions (millimeters/inches)

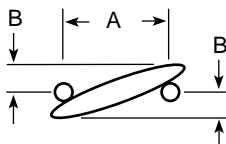

Device	A nom.	B max.
RUE090	5.1 (0.20)	0.8 (0.03)
RUE110	5.1 (0.20)	0.8 (0.03)
RUE135	5.1 (0.20)	1.0 (0.04)
RUE160	5.1 (0.20)	1.0 (0.04)
RUE185	5.1 (0.20)	1.0 (0.04)
RUE250	5.1 (0.20)	1.2 (0.05)
RUE300	5.1 (0.20)	1.5 (0.06)
RUE400	5.1 (0.20)	1.7 (0.07)
RUE500	10.2 (0.40)	1.0 (0.04)
RUE600	10.2 (0.40)	1.0 (0.04)
RUE700	10.2 (0.40)	1.2 (0.05)
RUE800	10.2 (0.40)	1.5 (0.06)
RUE900	10.2 (0.40)	1.5 (0.06)

Tape and reel specifications (dimensions in millimeters)

Product availability: RUE090–RUE400

Devices taped using EIA468-B/IEC286-2 standards. See table below and Figures 1 and 2 for details.

Dimension description	EIA mark	IEC mark	Dimensions	
			Dim. (mm)	Tol. (mm)
Carrier tape width	W	W	18	-0.5/+1.0
Hold down tape width: RUE090-RUE250	W_4	W_0	11	min.
Top distance between tape edges	W_6	W_2	3	max.
Sprocket hole position	W_5	W_1	9	-0.5/+0.75
Sprocket hole diameter*	D_0	D_0	4	-0.32/+0.2
Abscissa to plane (straight lead)	H	H	18.5	±3.0
Abscissa to plane (kinked lead)	H_0	H_0	16	±0.5
Abscissa to top RUE090–185	H_1	H_1	32.2	max.
Abscissa to top RUE250–400*			35.4	max.
Overall width w/lead protrusion RUE090–RUE250	C_1		43.2	max.
Overall width w/lead protrusion RUE250			43.9	max.
Overall width w/o lead protrusion RUE090–RUE185	C_2		42.5	max.
Overall width w/o lead protrusion RUE300–RUE400*			44.2	max.
Lead protrusion	L_1	l_1	1.0	max.
Protrusion of cut out	L	L	11	max.
Protrusion beyond hold-down tape	l_2	l_2	Not specified	
Sprocket hole pitch: RUE090–RUE250	P_0	P_0	12.7	±0.3
Sprocket hole pitch on RUE300–RUE400	P_0	P_0	25.4	±0.5
Device pitch: RUE090–RUE250			12.7	
Device pitch: RUE300–RUE400			25.4	
Pitch tolerance			20 consec.	±1
Tape thickness	t	t	0.9	max.
Tape thickness with splice RUE090-RUE250	t_1		1.5	max.
Tape thickness with splice RUE300-RUE400*	t_1		2.0	max.
Splice sprocket hole alignment			0	±0.3
Body lateral deviation	Δh	Δh	0	±1.0
Body tape plane deviation	Δp	Δp	0	±1.3
Ordinate to adjacent component lead*	P_1	P_1	3.81	±1.0
Lead spacing: RUE090–RUE400*	F	F	5.08	±0.8
Reel width RUE090–RUE300	w_2	w	56	max.
Reel width RUE400*	w_2	w	63.5	max.
Reel diameter	a	d	370	max.
Space between flanges less device*	w_1		4.75	3.25/+8.25
Arbor hole diameter	c	f	26	±12.0
Core diameter*	n	h	91	max.
Box			56/372/372	max.
Consecutive missing places			None	
Empty places per reel			0.1% max.	

*Differs from EIA specification

Figure 1: EIA Referenced Taped Component Dimensions

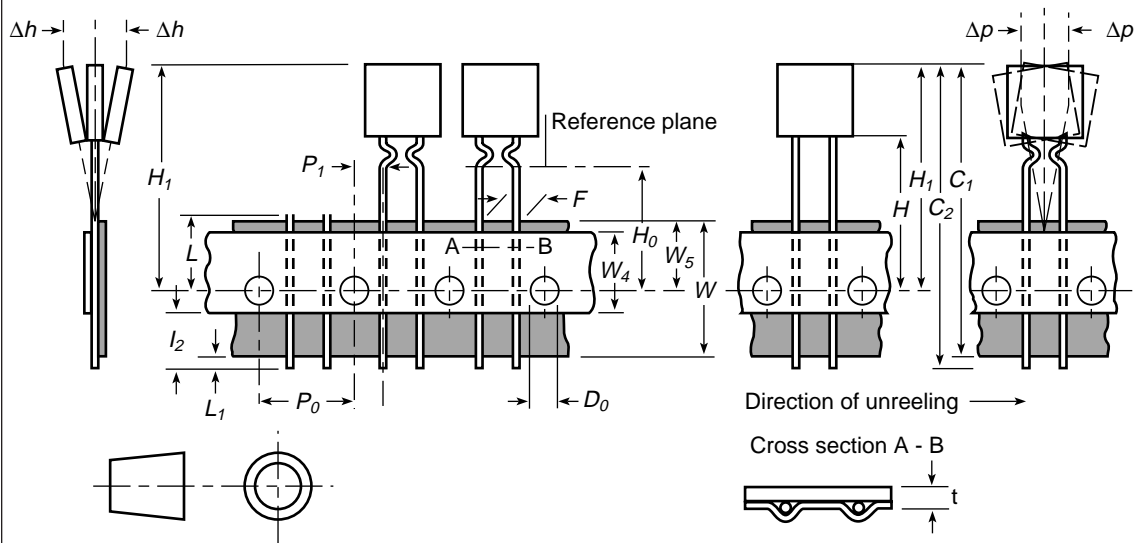

4

Figure 2: Reel Dimensions

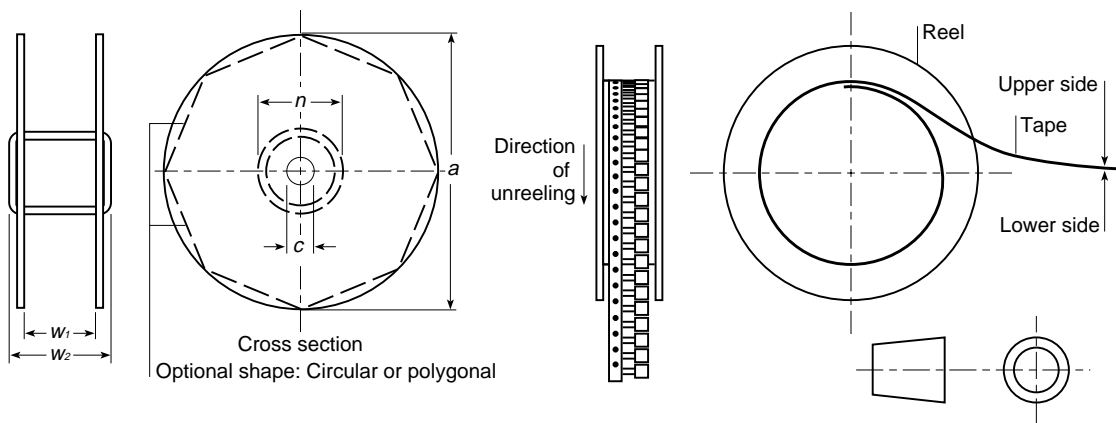

Ordering information

Product description	Bag quantity	Tape and reel quantity	AMMO pack	Standard package
RUE090	500			10000
RUE090-2		3000		15000
RUE090-AP			2000	10000
RUE110	500			10000
RUE110-2		3000		15000
RUE110-AP			2000	10000
RUE135	500			10000
RUE135-2		3000		15000
RUE135-AP			2000	10000
RUE160	500			10000
RUE160-2		3000		15000
RUE160-AP			2000	10000
RUE185	500			10000
RUE185-2		3000		15000
RUE185-AP			2000	10000
RUE250	500			10000
RUE250-2		3000		15000
RUE250-AP			2000	10000
RUE300	500			10000
RUE300-2		1500		7500
RUE300-AP			1000	5000
RUE400	500			10000
RUE400-2		1500		7500
RUE400-AP			1000	5000
RUE500	500	*	*	10000
RUE600	500	*	*	10000
RUE700	500	*	*	10000
RUE800	500	*	*	10000
RUE900	500	*	*	10000

*Consult Factory

4

Part numbering system

RUE suffix

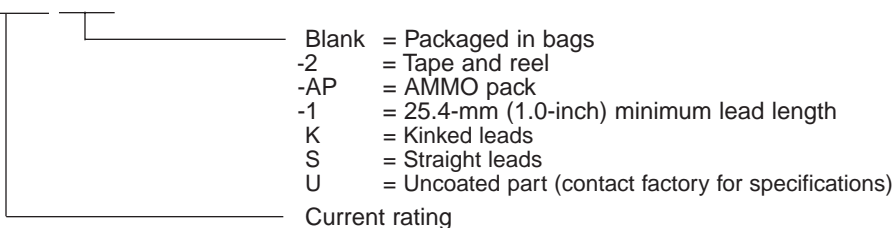

Part marking system

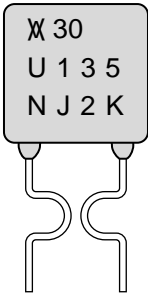

Example

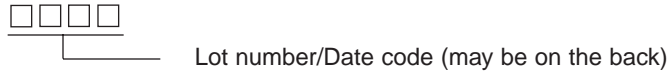
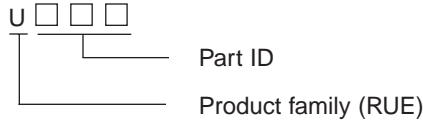
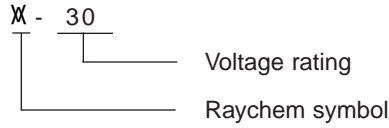

Part description	Part ID
RUE090	090
RUE110	110
RUE135	135
RUE160	160
RUE185	185
RUE250	250
RUE300	300
RUE400	400
RUE500	500
RUE600	600
RUE700	700
RUE800	800
RUE900	900

WARNING:

- Operation beyond maximum ratings or improper use may result in device damage and possible electrical arcing and flame.
- These devices are intended for protection against occasional over-current or overtemperature fault conditions, and should not be used when repeated fault conditions are anticipated.
- Operation in circuits with inductive spikes can generate voltages above the rated voltage of the devices and should be evaluated for suitability of use.