

## Features

- 5 - 45 GHz frequency range
- 2 dB typical insertion loss
- >30 dB attenuation range
- High linearity, 30 dBm IIP3
- Lead-Free 3 mm, 16-Lead QFN Package
- RoHS\* Compliant and 260°C Reflow Compatible

## Description

The MAAT-010521 is a voltage variable attenuator with analog control and up to 40 dB of attenuation. Excellent linearity is maintained over the full attenuation range. The attenuation level is set by two control voltages of 0 to -2V.

The 3mm QFN package is RoHS compliant and compatible with reflow temperatures to 260°C. Applications include transceivers for cellular infrastructure.

## Functional Block Diagram

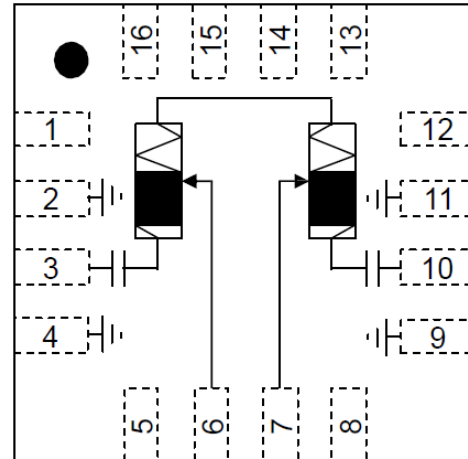

## Pin Configuration<sup>3,4</sup>

Pin No.	Function
1	No Connection
2	Ground
3	RF Input
4	Ground
5	No Connection
6	VC1
7	VC2
8	No Connection
9	Ground
10	RF Output
11	Ground
12	No Connection
13	No Connection
14	No Connection
15	No Connection
16	No Connection

## Ordering Information<sup>1,2</sup>

Part Number	Package
MAAT-010521-TR0500	500 piece reel
MAAT-010521-TR3000	3000 piece reel
MAAT-010521 -001SMB	Sample Test Board

1. Reference Application Note M513 for reel size information.
2. All sample boards include 5 loose parts.

\* Restrictions on Hazardous Substances,  
European Union Directive 2002/95/EC.

3. It is recommended to connect unused pins to ground.
4. The exposed pad centered on the package bottom must be connected to RF and DC ground.

**Electrical Specifications:  $T_A = +25^\circ\text{C}$ ,  $Z_0 = 50 \Omega$ ,  $P_{in} = -10 \text{ dBm}$**

Parameter	Test Conditions	Units	Min.	Typ.	Max.
Insertion Loss ( $V_{c1}$ and $V_{c2} = -2.0\text{V}$ )	10 GHz	dB	—	2	4
	20 GHz			2	4
	40 GHz			3	6
Attenuation ( $V_{c1}$ and $V_{c2} = 0\text{V}$ ) <sup>5</sup>	10 GHz	dB	26	30	—
	20 GHz		34	40	
	40 GHz		34	40	
Input P1dB	5 GHz to 25 GHz	dBm	24	25	—
	25 GHz to 40 GHz		20	22	
IIP3 (any attenuation)	Pin=12 dBm/tone @ 5-15 GHz Pin=12 dBm/tone @ 15-26.5 GHz Pin=12 dBm/tone @ 26.5-40 GHz	dBm	29	31	—
IIP3 ( $V_{c1}=V_{c2}=-2.0\text{V}$ )	Pin=12 dBm/tone @ 10, 20, and 40 GHz		28	30	
			25	28	
Input Return Loss (any attenuation)		dB	—	10	—
Output Return Loss (any attenuation)		dB	—	10	—

5. To increase attenuation from min. attenuation state ( $V_{C1} = -2\text{V}$  and  $V_{C2} = -2\text{V}$ ) to max attenuation state ( $V_{C1} = 0\text{V}$  and  $V_{C2} = 0\text{V}$ ),  $V_{C1}$  increases to full range prior to adjusting  $V_{C2}$ .

## Absolute Maximum Ratings<sup>6,7</sup>

Parameter	Absolute Maximum
Input Power	+30 dBm
Voltage (RF pins)	30 volts
Voltage (control pins)	+1 to -6 volts
Storage Temperature	-55°C to +150°C
Case Temperature	-40°C to +85°C

6. Exceeding any one or combination of these limits may cause permanent damage to this device.  
7. M/A-COM Technology does not recommend sustained operation near these survivability limits.

## Handling Procedures

The following precautions should be observed to avoid damage:

### Static Sensitivity

Gallium Arsenide Integrated Circuits are sensitive to electrostatic discharge (ESD) and can be damaged by static electricity. Proper ESD control techniques should be used when handling these class 1C (HBM) devices.

## Typical Performance Curves: S-Parameters

**Gain**

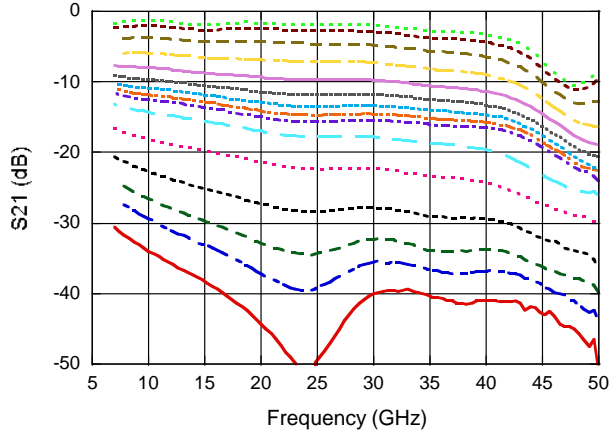

**Input Return Loss**

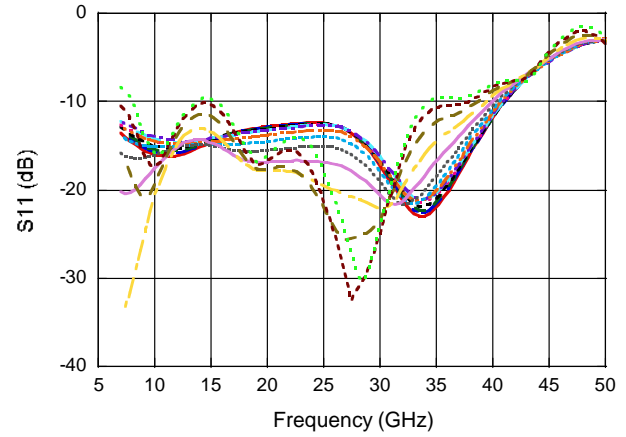

**Output Return Loss**

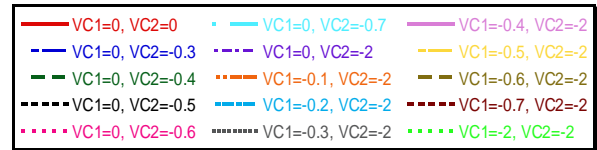
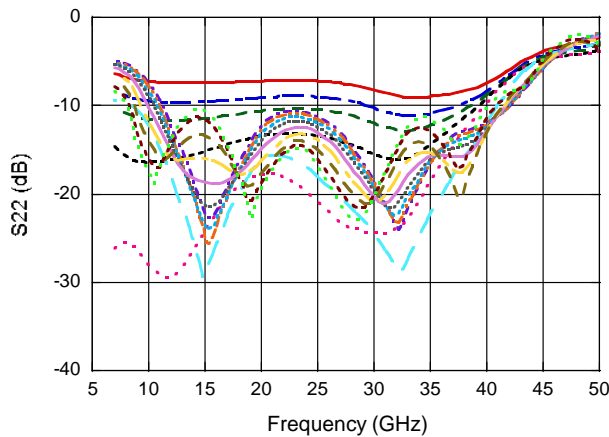

## Typical Performance Curves: S-Parameters

$VC1 = -2, VC2 = -2$

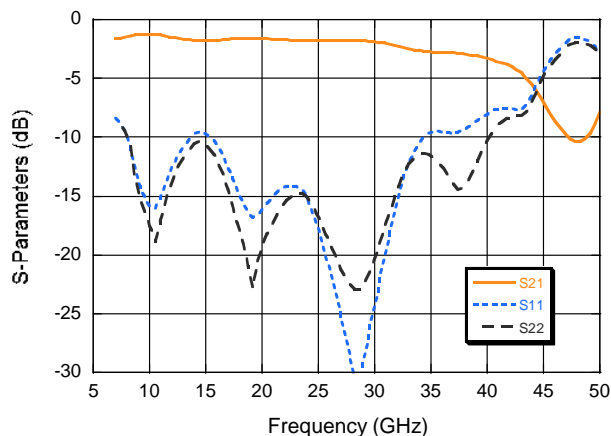

$VC1 = -0.6, VC2 = -2$

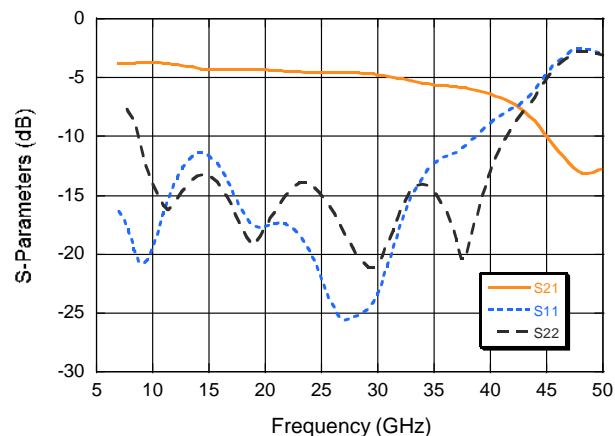

$VC1 = -0.4, VC2 = -2$

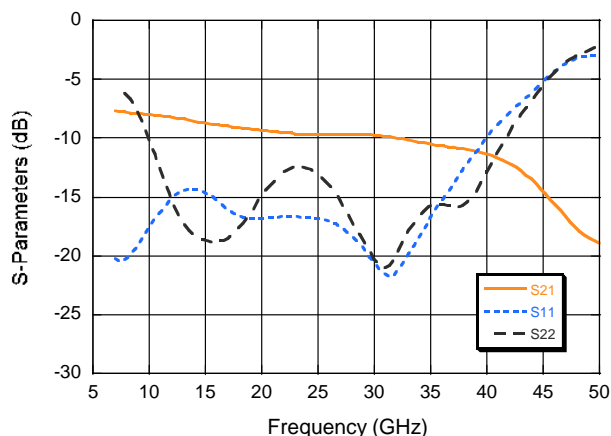

$VC1 = -0.1, VC2 = -2$

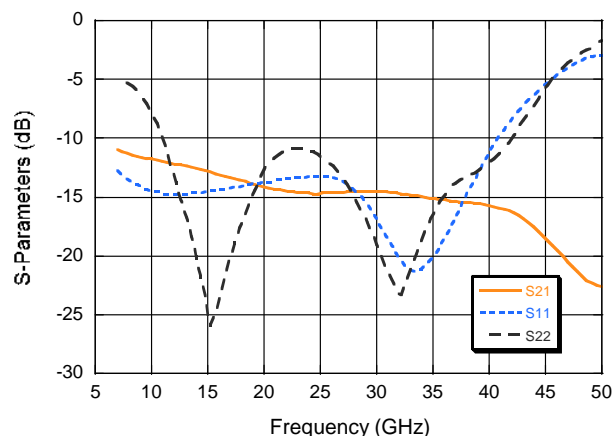

$VC1 = 0, VC2 = -0.6$

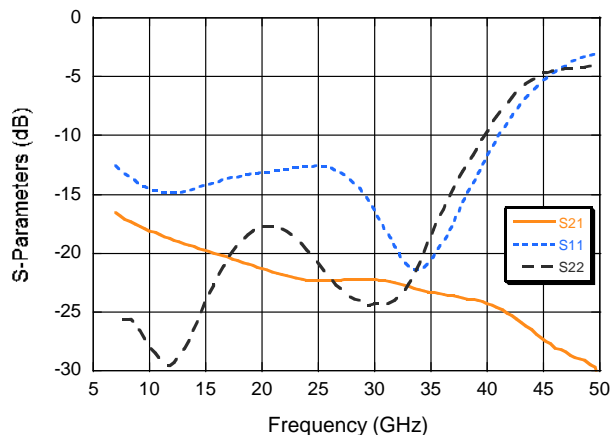

## Typical Performance Curves: Gain

Gain vs. Pin (VC1 = -2, VC2 = -2) @ 15 GHz

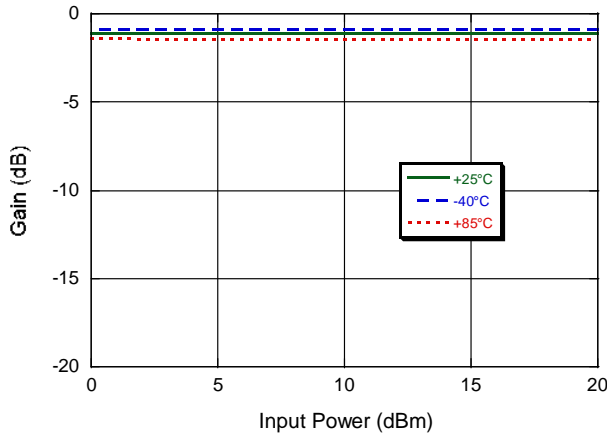

Gain vs. Pin (VC1 = -2, VC2 = -2)

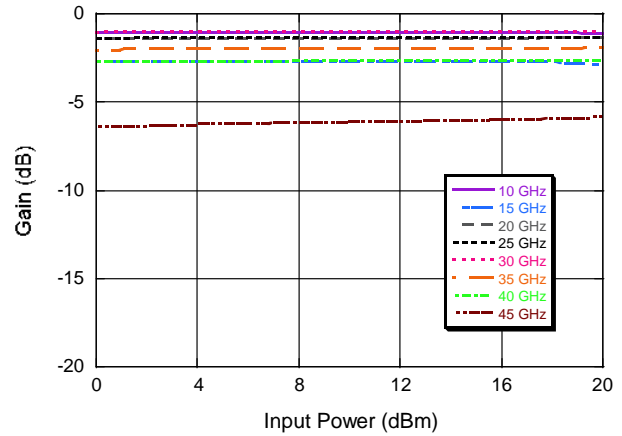

Gain vs. Pin (VC1 = -0.4, VC2 = -2) @ 15 GHz

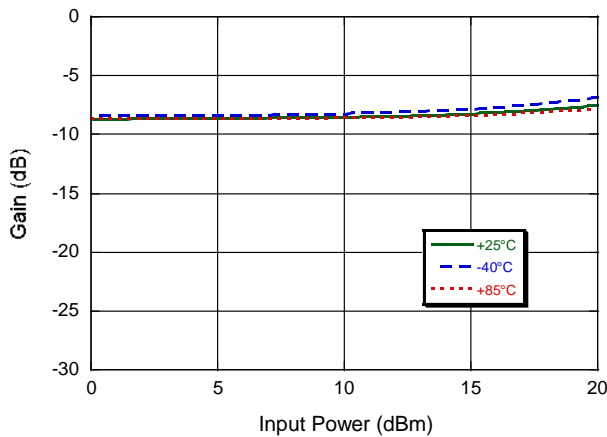

Gain vs. Pin (VC1 = -0.4, VC2 = -2)

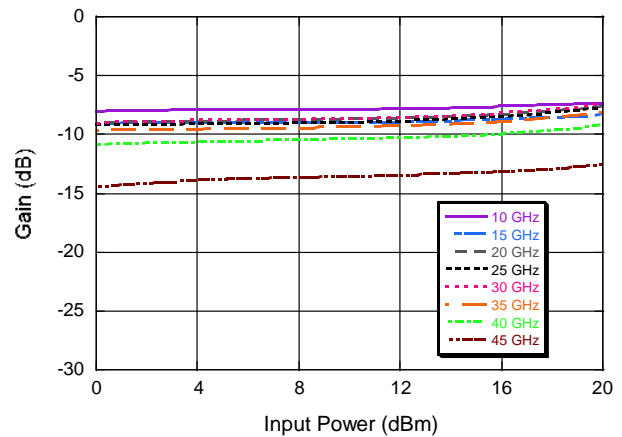

Gain vs. Pin (VC1 = 0, VC2 = -0.6) @ 25°C

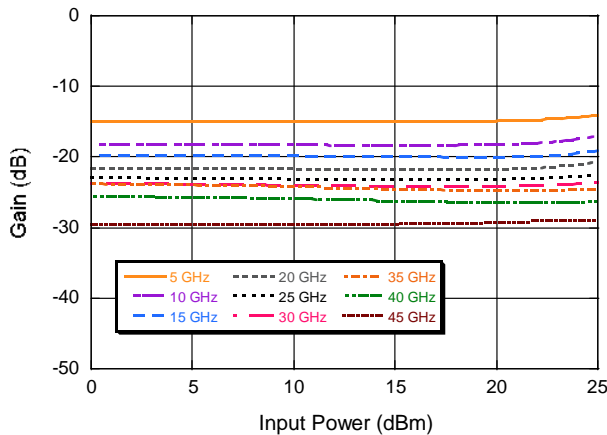

Gain vs. Pin (VC1 = 0, VC2 = 0) @ 25°C

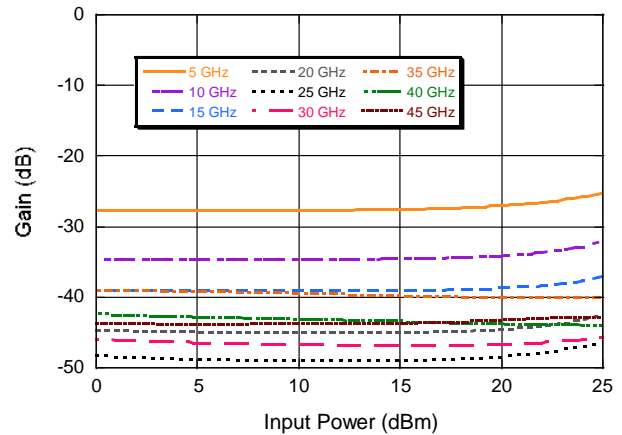

## Typical Performance Curves: Input IP3

Input IP3 (VC1 = -2, VC2 = -2)

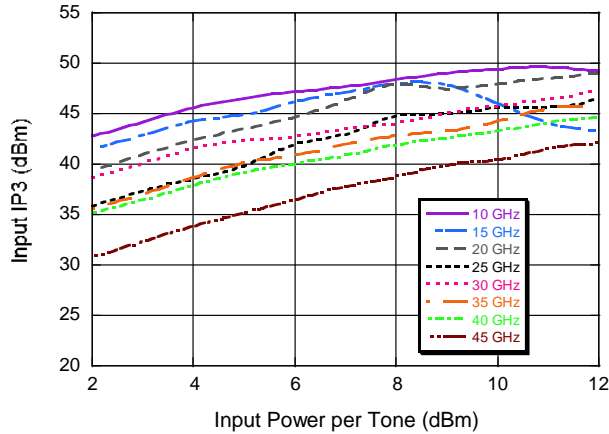

Input IP3 (Pin per tone = 12 dBm)

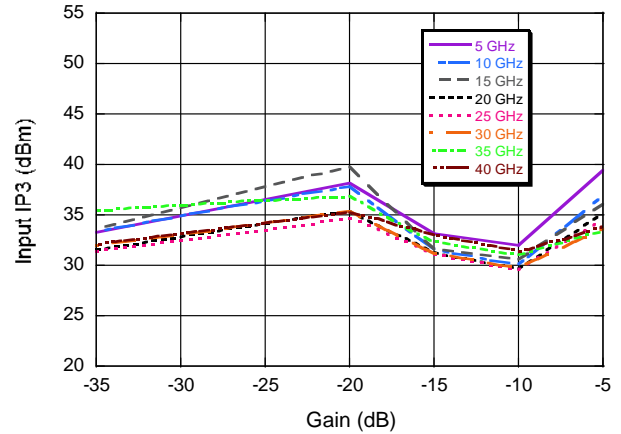

## Lead-Free 3 mm 16-Lead PQFN†

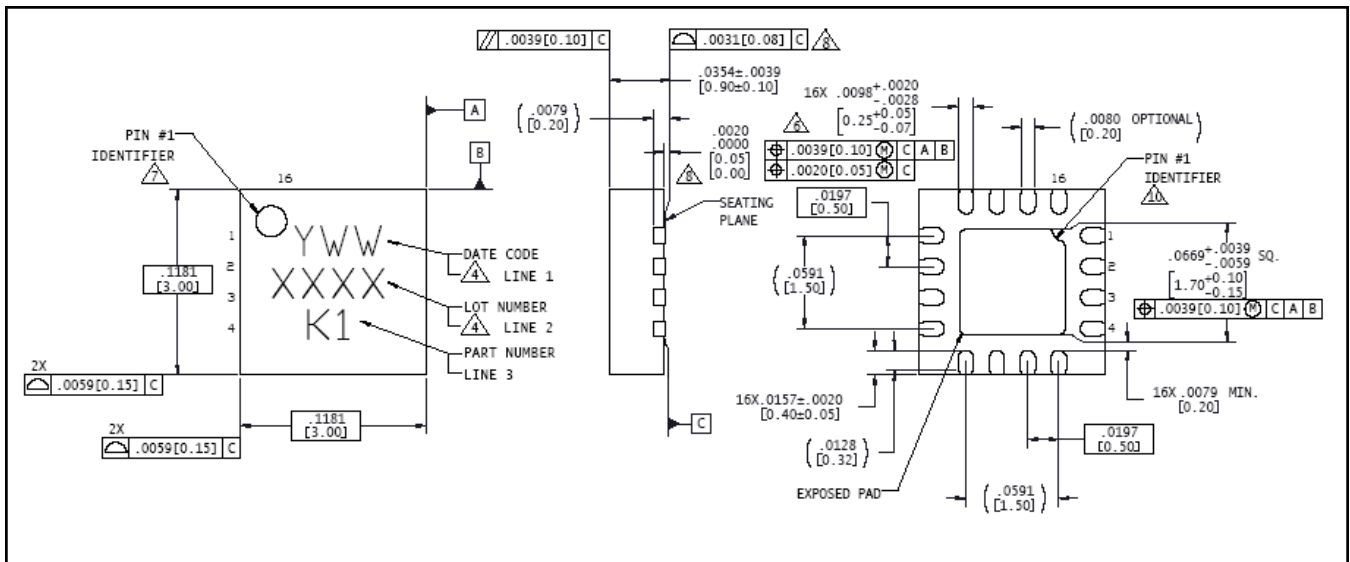

† Reference Application Note M538 for lead-free solder reflow recommendations. Meets JEDEC moisture sensitivity level 1 requirements. Plating is NiPdAuAg.