

# SAW Bandpass Filter F1G62



## Features

- RF Bandpass Filter
- High attenuation
- No matching 50Ω single-ended operation
- Ceramic Surface Mounted Device (SMD) Package ( 3.0 mm \* 3.0 mm )
- RoHS Compliant

## Package Dimensions

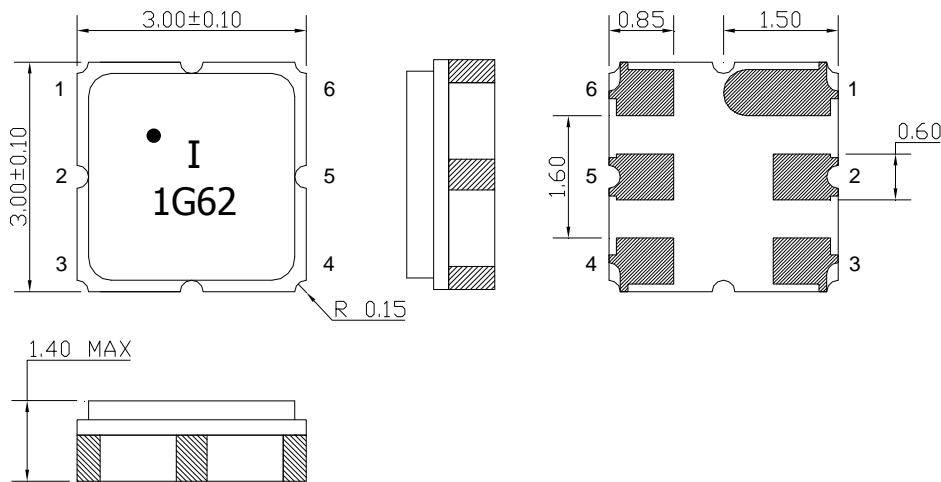

Dimensions shown are nominal in millimeters

Body : Al<sub>2</sub>O<sub>3</sub> Ceramic

Lid : Kovar, Ni Plated

Terminations : Au plating 0.3 ~ 1.0 μm, Over a 1.27 ~ 8.89 μm  
Ni Plating

### Pin Configuration

2	Input
5	Output
1, 3, 4, 6	Case ground

## Maximum Ratings

Parameter	Unit	Minimum	Typical	Maximum
Operating Temperature Range	℃	-20	25	75
Storage Temperature Range	℃	-40	25	85
Power Handling Capability	dBm	-	-	10

Electrostatics Sensitive Device (ESD)

	<b>ITF Co., Ltd.</b> 102-901, Bucheon Technopark 364, Samjeong-Dong, Ojeong-Gu, Bucheon-City, Gyeonggi-Do, Korea 421-809	Part No.	F1G62	
		Rev. Date	2012-05-25	
		Rev.	NCNE01-AS01	1/7

# SAW Bandpass Filter F1G62



## Specifications

Fc = 1642.5 MHz

Terminating source impedance : 50Ω

Terminating load impedance : 50Ω

	Minimum	Typical	Maximum	Unit
Center Frequency ( Fc )	-	1642.5	-	MHz
Insertion Loss (1625 ~ 1660 MHz)	-	1.8	3.5	dB
Amplitude Ripple (1625 ~ 1660 MHz)	-	0.7	2.0	dBp-p
VSWR (1625 ~ 1660 MHz)	-	1.7	2.3	
Relative Attenuation				
DC ~ 1500 MHz	21	29	-	dB
1525 ~ 1559 MHz	30	36	-	
1700 ~ 2050 MHz	30	32	-	
2050 ~ 3500 MHz	25	32	-	
Input/Output Impedance		50		Ohms

### Notes :

- 1) All specifications are based on the matching schematic shown below, measured by Agilent Network analyzer and full 2 port calibration.
- 2) Electrical margin has been built into the design to account for the variations due to temperature drift and manufacturing tolerances

	<b>ITF Co., Ltd.</b> 102-901, Bucheon Technopark 364, Samjeong-Dong, Ojeong-Gu, Bucheon-City, Gyeonggi-Do, Korea 421-809	Part No.	F1G62	
		Rev. Date	2012-05-25	
		Rev.	NCNE01-AS01	2/7

# SAW Bandpass Filter F1G62



## Matching Schematic

( Actual matching values may vary due to PCB layout and parasitics )



## Marking Configuration

- <sup>1)</sup>  
I<sup>2)</sup>  
1G62<sup>3)</sup>

1) Pad Number 1 Index

2) Manufacturer name

3) Marking Number

\* Ink or Laser Marking available

 Integrated Technology Future	<b>ITF Co., Ltd.</b> 102-901, Bucheon Technopark 364, Samjeong-Dong, Ojeong-Gu, Bucheon-City, Gyeonggi-Do, Korea 421-809	Part No.	F1G62	
		Rev. Date	2012-05-25	
		Rev.	NCNE01-AS01	3/7

# SAW Bandpass Filter F1G62



## Typical Performance ( at 25°C )

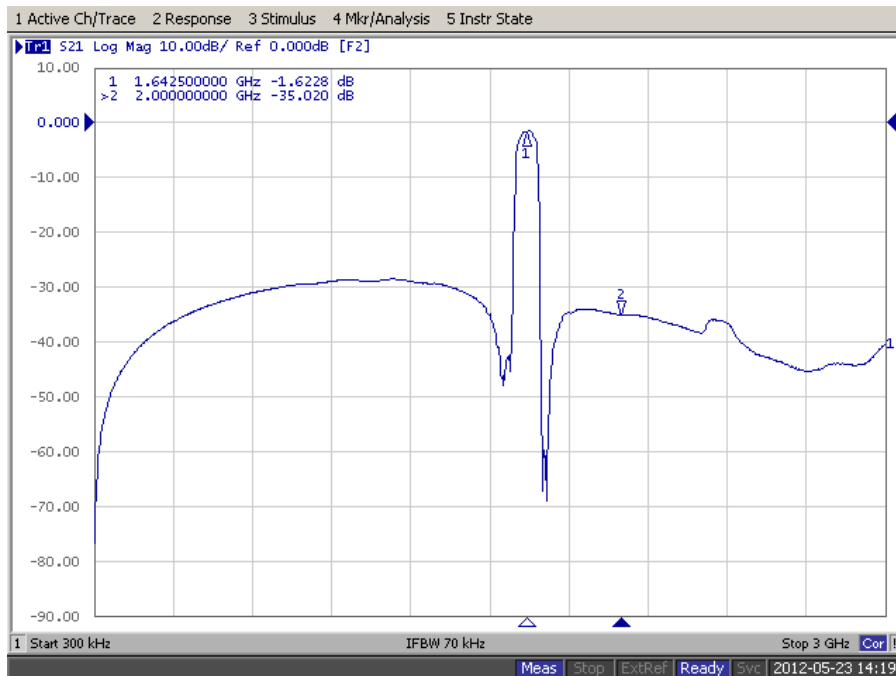
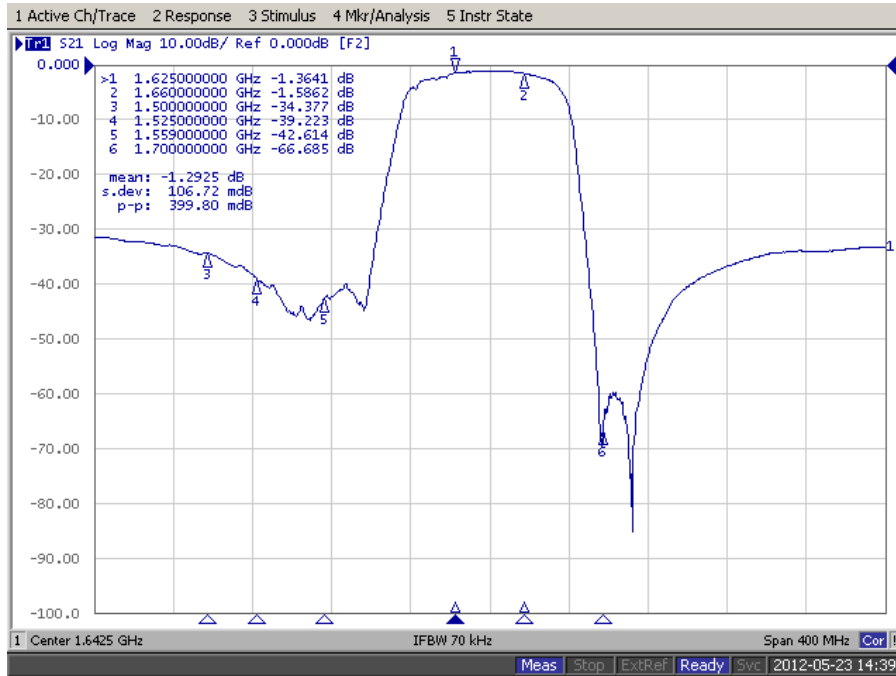

**ITF Co., Ltd.**  
 102-901, Bucheon Technopark 364,  
 Samjeong-Dong, Ojeong-Gu, Bucheon-City,  
 Gyeonggi-Do, Korea 421-809

Part No.	F1G62	
Rev. Date	2012-05-25	
Rev.	NCNE01-AS01	4/7

# SAW Bandpass Filter F1G62



## Input / Output VSWR Charts

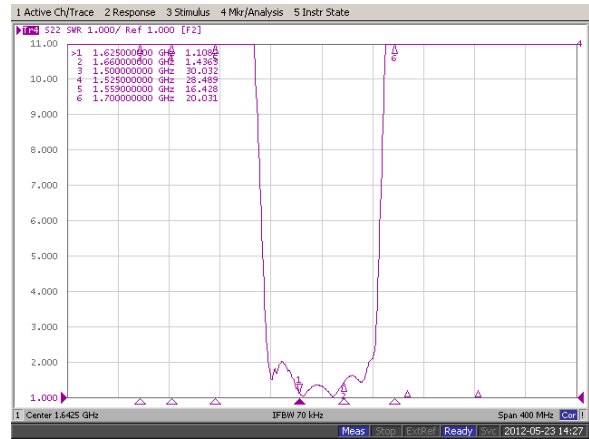
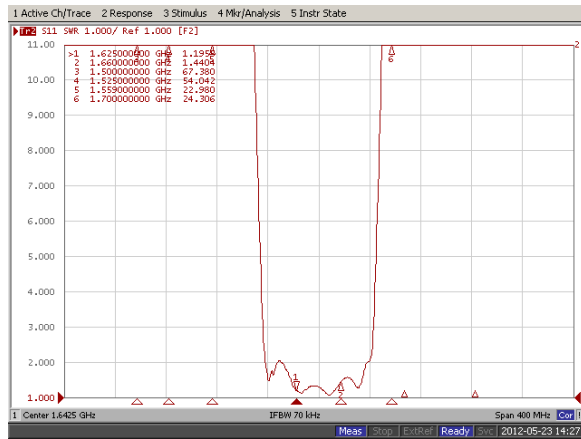

## Input / Output Smith Charts

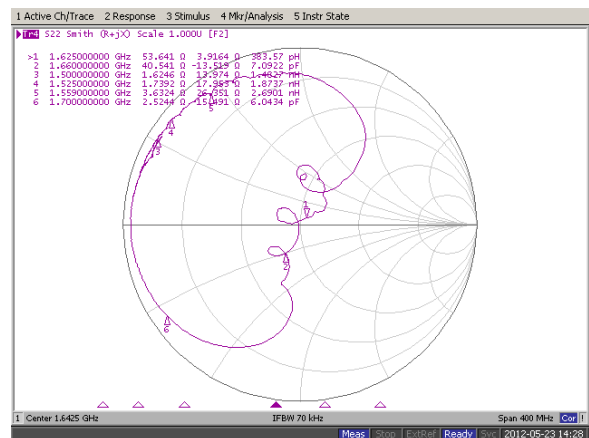
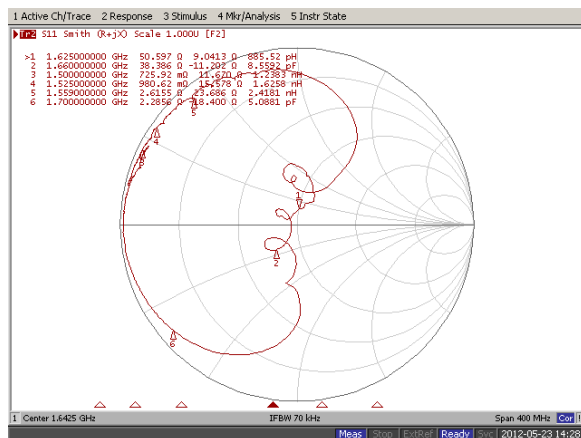

**ITF Co., Ltd.**  
 102-901, Bucheon Technopark 364,  
 Samjeong-Dong, Ojeong-Gu, Bucheon-City,  
 Gyeonggi-Do, Korea 421-809

Part No.	FIG62	
Rev. Date	2012-05-25	
Rev.	NCNE01-AS01	5/7

# SAW Bandpass Filter F1G62



## Packing Specification

1. Reeling Quantity : 3000 pcs / 13" reel ( or 1000 pcs / 7" reel )
2. Taping Structure : The tape shall be wound around the reel in the direction shown below.

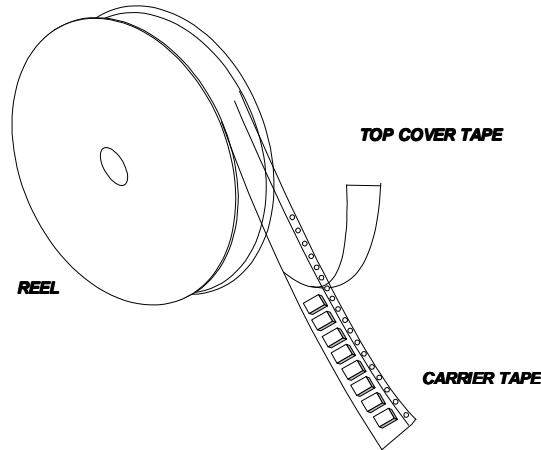

## Tape Specification

1. Leader part and vacant position specification

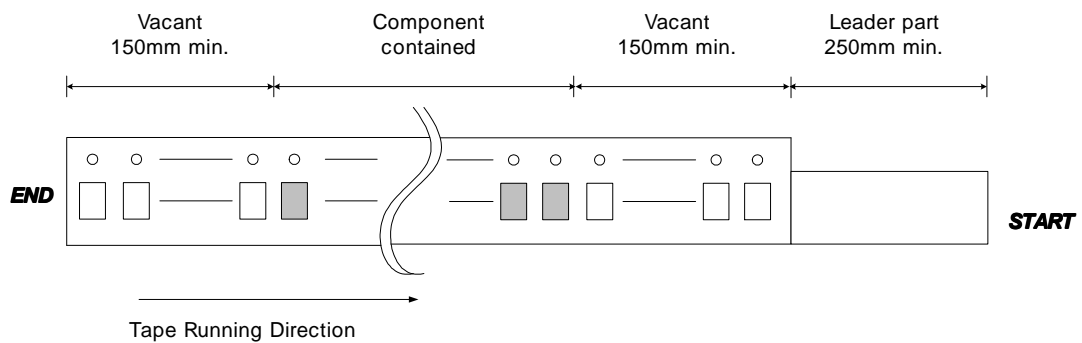

2. Tensile strength of carrier tape

4.4N/mm width

3. Top cover tape adhesion

- 1) pull off angle : 0~15°
- 2) speed : 300mm/min
- 3) force : 20~70g

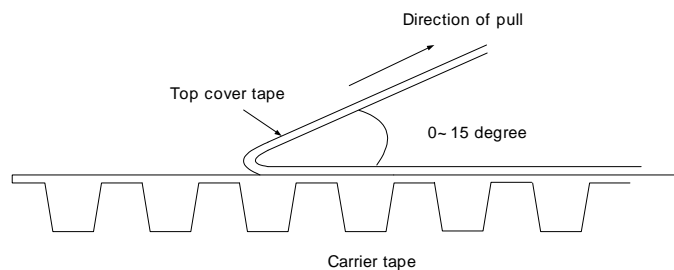

	<b>ITF Co., Ltd.</b> 102-901, Bucheon Technopark 364, Samjeong-Dong, Ojeong-Gu, Bucheon-City, Gyeonggi-Do, Korea 421-809	Part No.	F1G62	
		Rev. Date	2012-05-25	
		Rev.	NCNE01-AS01	6/7

# SAW Bandpass Filter F1G62



## Carrier Tape Dimensions [unit : mm]

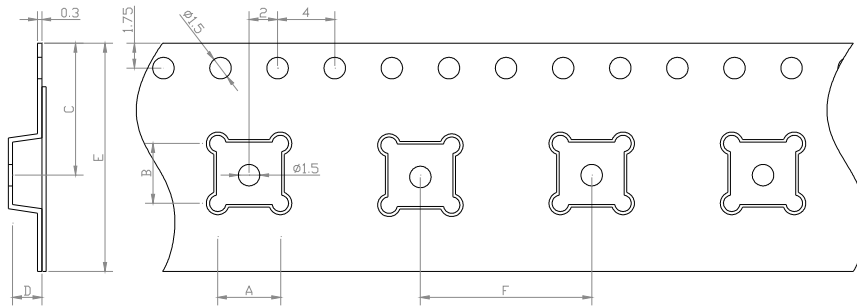

A	3.40 ± 0.1
B	3.40 ± 0.1
C	7.25 ± 0.1
D	1.70 ± 0.1
E	12.00 ± 0.1
F	8.00 ± 0.1

## Part Direction

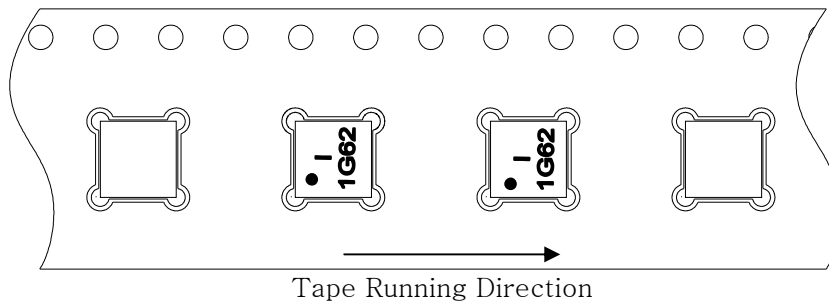

## Reel Dimensions [unit : mm]

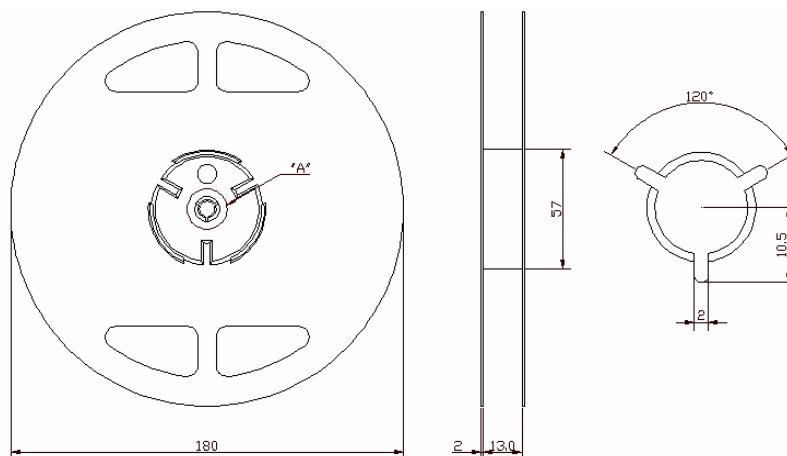

	<b>ITF Co., Ltd.</b> 102-901, Bucheon Technopark 364, Samjeong-Dong, Ojeong-Gu, Bucheon-City, Gyeonggi-Do, Korea 421-809	Part No.	F1G62	
		Rev. Date	2012-05-25	
		Rev.	NCNE01-AS01	7/7