



SWITCH FUNCTION		
POS. 1	POS. 2	POS. 3
		
ON	ON	ON
2-3, 5-6, 8-9, 11-2	2-3, 5-4, 8-9, 11-10	2-1, 5-4, 8-7, 11-10



ISOMETRIC

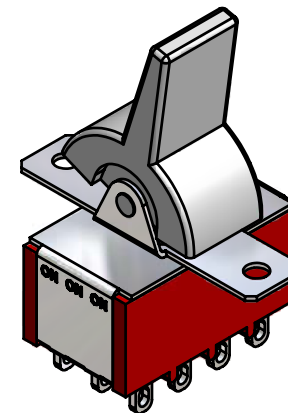
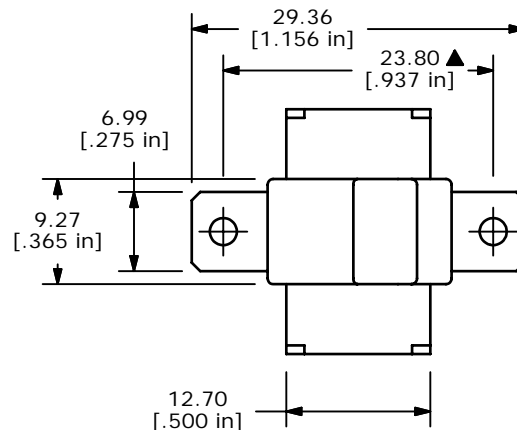
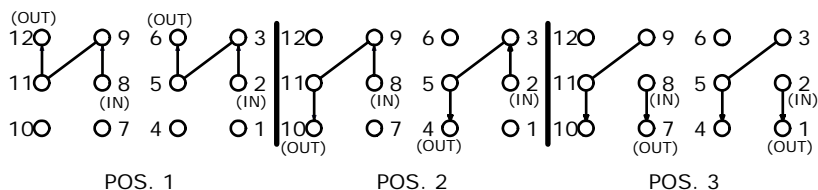

4PDT 3 WAY CIRCUIT  
NOTE: JUMPER PIN 3 TO 5, 9 TO 11

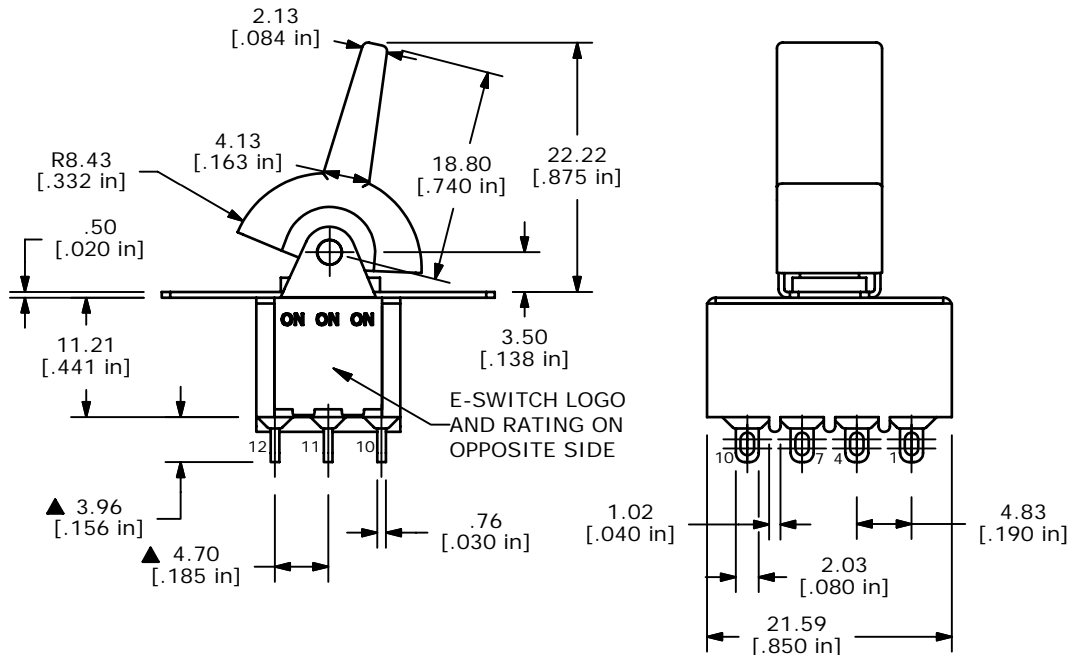

NOTE:

1. ALL DIMENSIONS IN MM [INCH]
2. GENERAL TOLERANCE: X.X=±0.4  
X.XX=±0.25
3. TERMINAL NUMBERS FOR REF ONLY
- ▲ 4. PLATING MATERIAL: SILVER
5. RATING: 2A @250VAC, 5A @120VAC OR 28VDC
6. ELECTRIC LIFE: 40,000 MAKE-AND-BREAK CYCLES AT FULL LOAD.
7. INSULATION RESISTANCE: 1,000 MEGA-OHM MIN.
8. DIELECTRIC STRENGTH: 1,000 V RMS @SEA LEVEL.
9. OPERATING TEMP.: -30°C to 85°C
10. ▲ DENOTES CRITICAL PARAMETER.
11. 2002/95/EC (ROHS) COMPLIANT

B	16058	EDIT DIMENSIONS	5/30/06	CT
A	15984	NEW PART RELEASE	4/24/06	CT
REV	PCR NO	DESCRIPTION	DATE	BY

THE INFORMATION CONTAINED IN THIS DOCUMENT IS PROPRIETARY TO E-SWITCH AND IS NOT TO BE COPIED OR TRANSFERRED

**E-SWITCH®**

TITLE 3004P6R2BLKM1QE

SCALE	DATE	DR	DWG	REV
1.5:1	4/24/2006	CT	T346018	B