

- RoHS Compliant Containing No Lead and Halogen Free ①
- Integrated Monolithic Schottky Diode
- Low Profile (<0.7 mm)
- Dual Sided Cooling Compatible ①
- Ultra Low Package Inductance
- Optimized for High Frequency Switching ①
- Ideal for CPU Core DC-DC Converters
- Optimized for Sync. FET socket of Sync. Buck Converter①
- Low Conduction and Switching Losses
- Compatible with existing Surface Mount Techniques ①
- 100% Rg tested

HEXFET® Power MOSFET plus Schottky Diode ②  
 Typical values (unless otherwise specified)

$V_{DS}$	$V_{GS}$	$R_{DS(on)}$	$R_{DS(on)}$		
30V max	±20V max	1.8mΩ @ 10V	2.8mΩ @ 4.5V		
$Q_{g\ tot}$	$Q_{gd}$	$Q_{gs2}$	$Q_{rr}$	$Q_{oss}$	$V_{gs(th)}$
25nC	6.7nC	3.0nC	29nC	22nC	1.8V

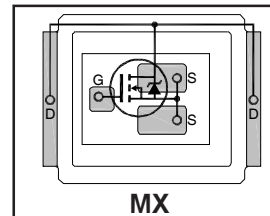

Applicable DirectFET Outline and Substrate Outline (see p.7,8 for details)①

SQ	SX	ST		MQ	<b>MX</b>	MT	MP			
----	----	----	--	----	-----------	----	----	--	--	--

### Description

The IRF8306MPbF combines the latest HEXFET® Power MOSFET Silicon technology with the advanced DirectFET™ packaging to achieve the lowest on-state resistance in a package that has the footprint of a SO-8 and only 0.7 mm profile. The DirectFET package is compatible with existing layout geometries used in power applications, PCB assembly equipment and vapor phase, infra-red or convection soldering techniques. Application note AN-1035 is followed regarding the manufacturing methods and processes. The DirectFET package allows dual sided cooling to maximize thermal transfer in power systems, improving previous best thermal resistance by 80%.

The IRF8306MPbF balances industry leading on-state resistance while minimizing gate charge along with ultra low package inductance to reduce both conduction and switching losses. This part contains an integrated Schottky diode to reduce the Qrr of the body drain diode further reducing the losses in a Synchronous Buck circuit. The reduced losses make this product ideal for high frequency/high efficiency DC-DC converters that power high current loads such as the latest generation of microprocessors. The IRF8306MPbF has been optimized for parameters that are critical in synchronous buck converter's Sync FET sockets.

Orderable part number	Package Type	Standard Pack		Note
		Form	Quantity	
IRF8306MTRPbF	DirectFET MX	Tape and Reel	4800	"TR" suffix
IRF8306MTR1PbF	DirectFET MX	Tape and Reel	4000	"TR1" suffix EOL notice # 264

### Absolute Maximum Ratings

	Parameter	Max.	Units
$V_{DS}$	Drain-to-Source Voltage	30	V
$V_{GS}$	Gate-to-Source Voltage	±20	
$I_D @ T_A = 25^\circ C$	Continuous Drain Current, $V_{GS} @ 10V$ ③	23	A
$I_D @ T_A = 70^\circ C$	Continuous Drain Current, $V_{GS} @ 10V$ ③	18	
$I_D @ T_C = 25^\circ C$	Continuous Drain Current, $V_{GS} @ 10V$ ④	140	
$I_{DM}$	Pulsed Drain Current ⑤	180	
$E_{AS}$	Single Pulse Avalanche Energy ⑥	230	mJ
$I_{AR}$	Avalanche Current ⑤	18	A

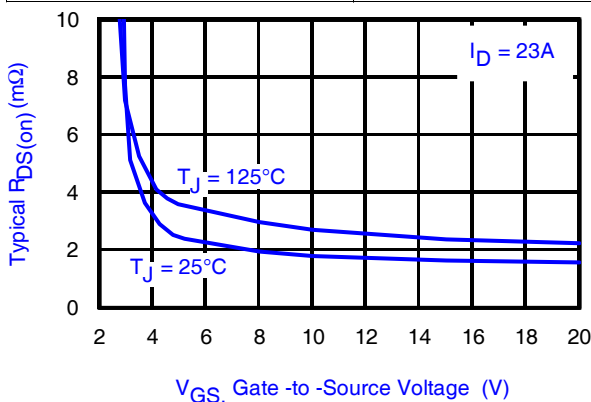

Fig 1. Typical On-Resistance vs. Gate Voltage

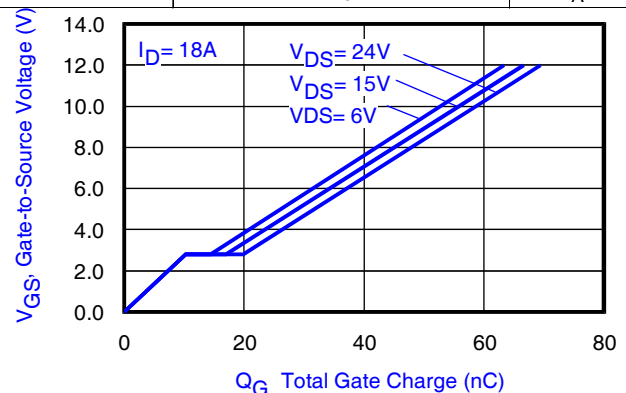

Fig 2. Typical Total Gate Charge vs. Gate-to-Source Voltage

Notes:

- ① Click on this section to link to the appropriate technical paper.
- ② Click on this section to link to the DirectFET Website.
- ③ Surface mounted on 1 in. square Cu board, steady state.

- ④  $T_C$  measured with thermocouple mounted to top (Drain) of part.
- ⑤ Repetitive rating; pulse width limited by max. junction temperature.
- ⑥ Starting  $T_J = 25^\circ C$ ,  $L = 1.37mH$ ,  $R_G = 50\Omega$ ,  $I_{AS} = 18A$ .

**Static @ T<sub>J</sub> = 25°C (unless otherwise specified)**

	Parameter	Min.	Typ.	Max.	Units	Conditions
BV <sub>DSS</sub>	Drain-to-Source Breakdown Voltage	30	—	—	V	V <sub>GS</sub> = 0V, I <sub>D</sub> = 1.0mA
ΔBV <sub>DSS</sub> /ΔT <sub>J</sub>	Breakdown Voltage Temp. Coefficient	—	2.7	—	mV/°C	Reference to 25°C, I <sub>D</sub> = 6mA
R <sub>DS(on)</sub>	Static Drain-to-Source On-Resistance	—	1.8	2.5	mΩ	V <sub>GS</sub> = 10V, I <sub>D</sub> = 23A ⑦
		—	2.8	3.6		V <sub>GS</sub> = 4.5V, I <sub>D</sub> = 18A ⑦
V <sub>GS(th)</sub>	Gate Threshold Voltage	1.35	1.8	2.35	V	V <sub>DS</sub> = V <sub>GS</sub> , I <sub>D</sub> = 100μA
ΔV <sub>GS(th)</sub> /ΔT <sub>J</sub>	Gate Threshold Voltage Coefficient	—	-4.8	—	mV/°C	V <sub>DS</sub> = V <sub>GS</sub> , I <sub>D</sub> = 10mA
I <sub>DSS</sub>	Drain-to-Source Leakage Current	—	—	500	μA	V <sub>DS</sub> = 24V, V <sub>GS</sub> = 0V
		—	—	5.0	mA	V <sub>DS</sub> = 24V, V <sub>GS</sub> = 0V, T <sub>J</sub> = 125°C
I <sub>GSS</sub>	Gate-to-Source Forward Leakage	—	—	100	nA	V <sub>GS</sub> = 20V
	Gate-to-Source Reverse Leakage	—	—	-100	nA	V <sub>GS</sub> = -20V
g <sub>fs</sub>	Forward Transconductance	61	—	—	S	V <sub>DS</sub> = 15V, I <sub>D</sub> = 18A
Q <sub>g</sub>	Total Gate Charge	—	25	38	nC	V <sub>DS</sub> = 15V V <sub>GS</sub> = 4.5V I <sub>D</sub> = 18A See Fig. 15
Q <sub>gs1</sub>	Pre-V <sub>th</sub> Gate-to-Source Charge	—	7.3	—		
Q <sub>gs2</sub>	Post-V <sub>th</sub> Gate-to-Source Charge	—	3.0	—		
Q <sub>gd</sub>	Gate-to-Drain Charge	—	6.7	—		
Q <sub>godr</sub>	Gate Charge Overdrive	—	8.0	—		
Q <sub>sw</sub>	Switch Charge (Q <sub>gs2</sub> + Q <sub>gd</sub> )	—	9.7	—		
Q <sub>oss</sub>	Output Charge	—	22	—	nC	V <sub>DS</sub> = 16V, V <sub>GS</sub> = 0V
R <sub>G</sub>	Gate Resistance	—	1.3	—	Ω	
t <sub>d(on)</sub>	Turn-On Delay Time	—	16	—	ns	V <sub>DD</sub> = 15V, V <sub>GS</sub> = 4.5V ⑦ I <sub>D</sub> = 18A R <sub>G</sub> = 1.8Ω See Fig. 17
t <sub>r</sub>	Rise Time	—	34	—		
t <sub>d(off)</sub>	Turn-Off Delay Time	—	19	—		
t <sub>f</sub>	Fall Time	—	19	—		
C <sub>iss</sub>	Input Capacitance	—	4110	—	pF	V <sub>GS</sub> = 0V V <sub>DS</sub> = 15V f = 1.0MHz
C <sub>oss</sub>	Output Capacitance	—	970	—		
C <sub>rss</sub>	Reverse Transfer Capacitance	—	340	—		

**Diode Characteristics**

	Parameter	Min.	Typ.	Max.	Units	Conditions
I <sub>S</sub>	Continuous Source Current (Body Diode)	—	—	23	A	MOSFET symbol showing the integral reverse p-n junction diode.
I <sub>SM</sub>	Pulsed Source Current (Body Diode) ⑤	—	—	180		
V <sub>SD</sub>	Diode Forward Voltage	—	0.7	0.75	V	T <sub>J</sub> = 25°C, I <sub>S</sub> = 18A, V <sub>GS</sub> = 0V ⑦
t <sub>rr</sub>	Reverse Recovery Time	—	21	32	ns	T <sub>J</sub> = 25°C, I <sub>F</sub> = 18A
Q <sub>rr</sub>	Reverse Recovery Charge	—	29	44	nC	di/dt = 300A/μs ⑦

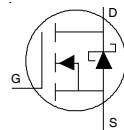
**Notes:**

⑦ Pulse width ≤ 400μs; duty cycle ≤ 2%.

**Absolute Maximum Ratings**

	Parameter	Max.	Units
$P_D @ T_A = 25^\circ\text{C}$	Power Dissipation ③	2.1	W
$P_D @ T_A = 70^\circ\text{C}$	Power Dissipation ③	1.3	
$P_D @ T_C = 25^\circ\text{C}$	Power Dissipation ④	75	
$T_P$	Peak Soldering Temperature	270	°C
$T_J$	Operating Junction and	-40 to + 150	
$T_{STG}$	Storage Temperature Range		

**Thermal Resistance**

	Parameter	Typ.	Max.	Units
$R_{\theta JA}$	Junction-to-Ambient ③⑩	—	60	°C/W
$R_{\theta JA}$	Junction-to-Ambient ⑧⑩	12.5	—	
$R_{\theta JA}$	Junction-to-Ambient ⑨⑩	20	—	
$R_{\theta JC}$	Junction-to-Case ④⑩	—	1.66	
$R_{\theta J-PCB}$	Junction-to-PCB Mounted	1.0	—	
	Linear Derating Factor ③	0.017		W/°C

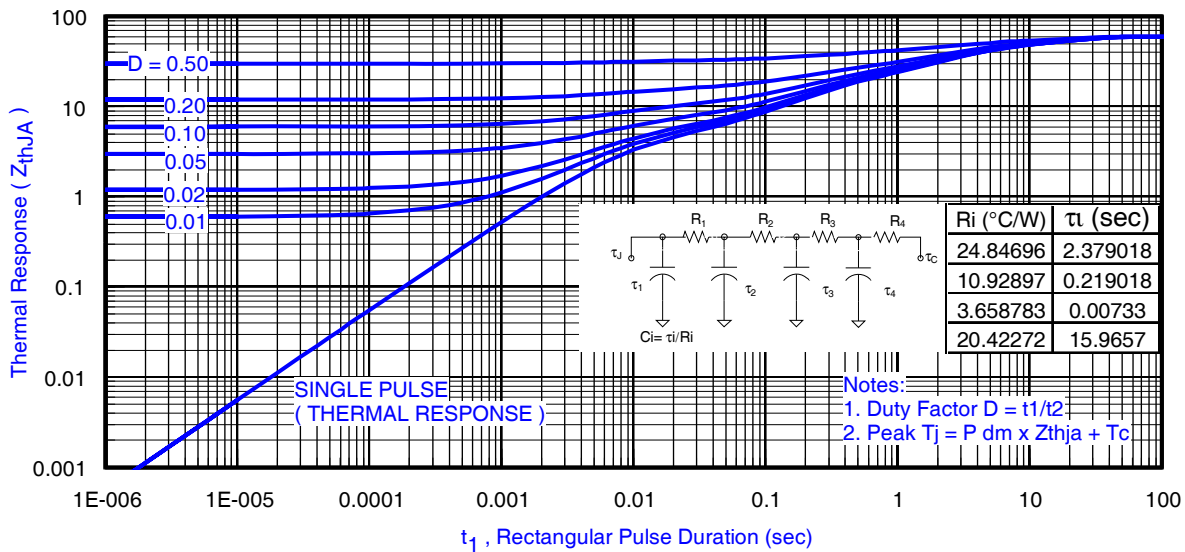

**Fig 3. Maximum Effective Transient Thermal Impedance, Junction-to-Ambient ③**

**Notes:**

- ③ Used double sided cooling , mounting pad with large heatsink.
- ④ Mounted on minimum footprint full size board with metalized back and with small clip heatsink.
- ⑧  $R_{\theta}$  is measured at  $T_J$  of approximately 90°C.



③ Surface mounted on 1 in. square Cu (still air).

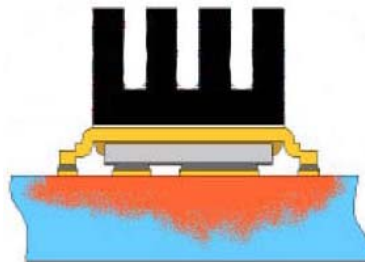

⑧ Mounted to a PCB with small clip heatsink (still air)

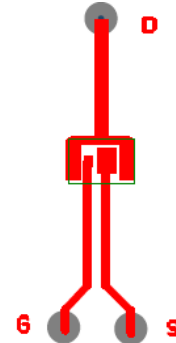

⑨ Mounted on minimum footprint full size board with metalized back and with small clip heatsink (still air)

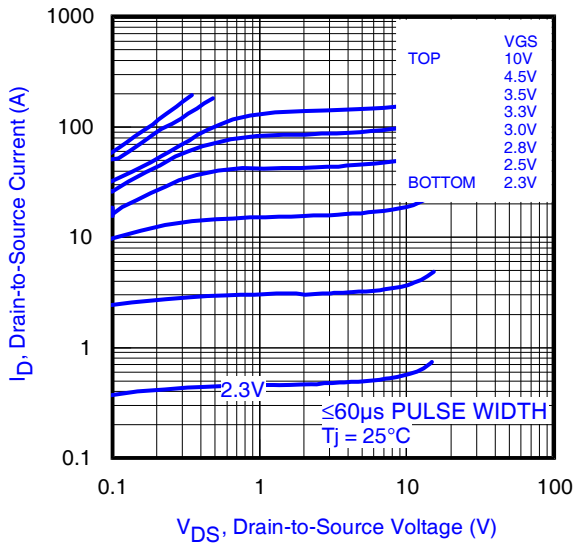

Fig 4. Typical Output Characteristics

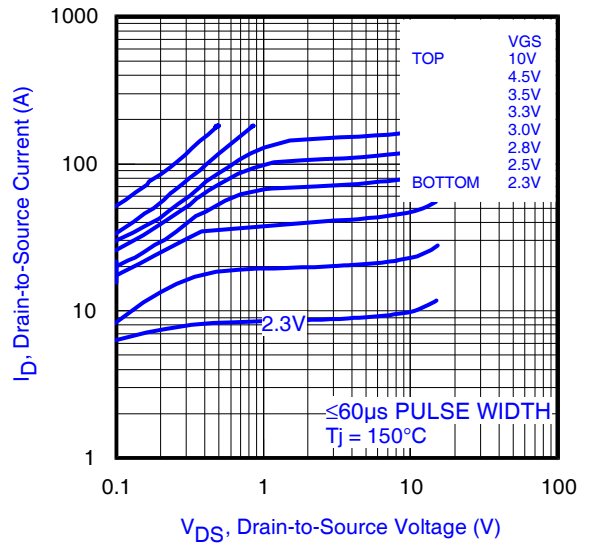

Fig 5. Typical Output Characteristics

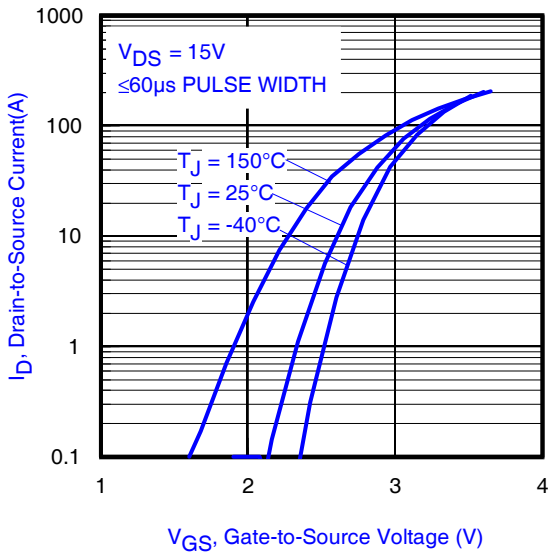

Fig 6. Typical Transfer Characteristics

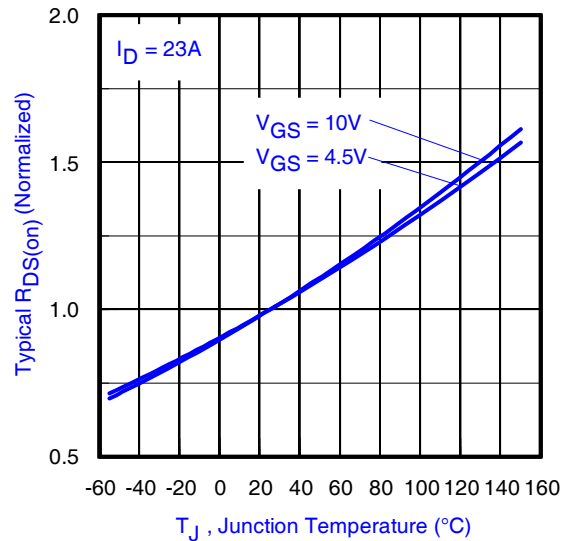

Fig 7. Normalized On-Resistance vs. Temperature

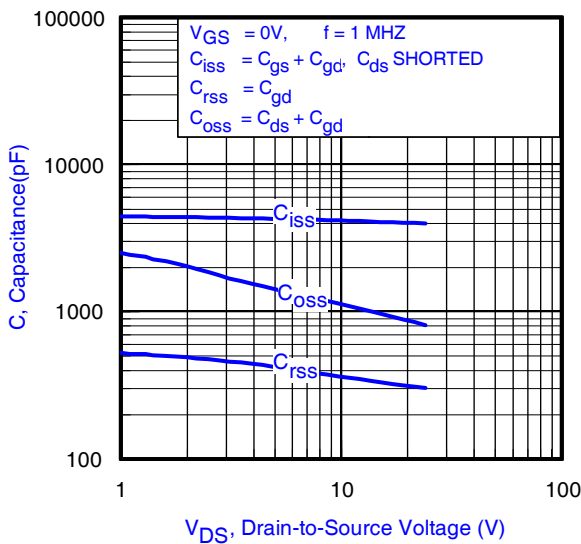

Fig 8. Typical Capacitance vs. Drain-to-Source Voltage

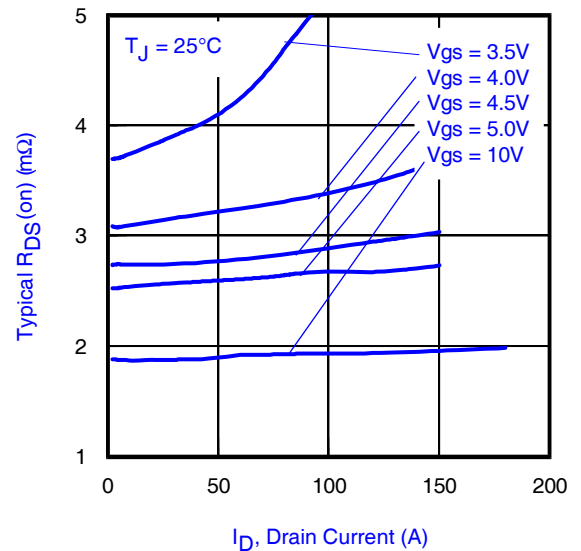

Fig 9. Typical On-Resistance vs. Drain Current and Gate Voltage

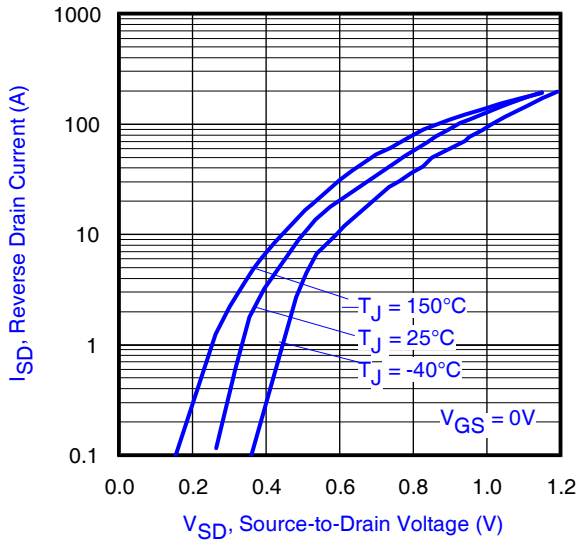

Fig 10. Typical Source-Drain Diode Forward Voltage

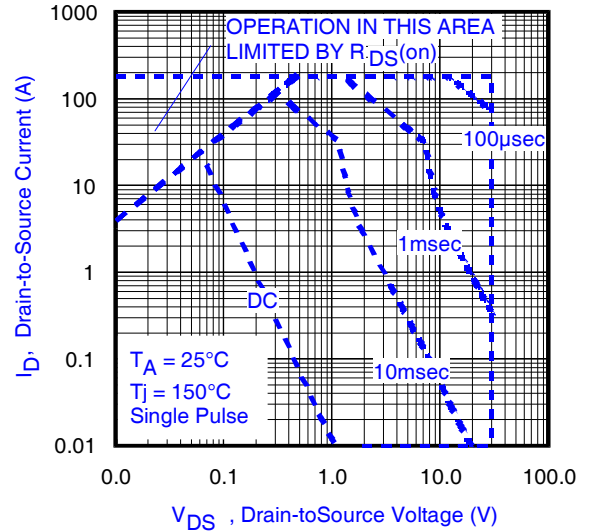

Fig11. Maximum Safe Operating Area

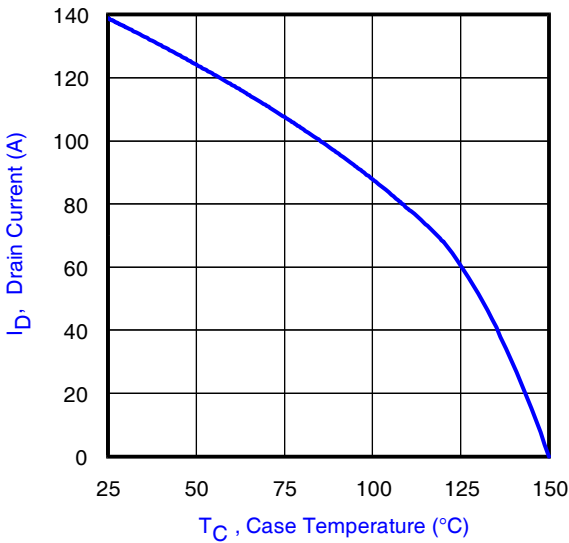

Fig 12. Maximum Drain Current vs. Case Temperature

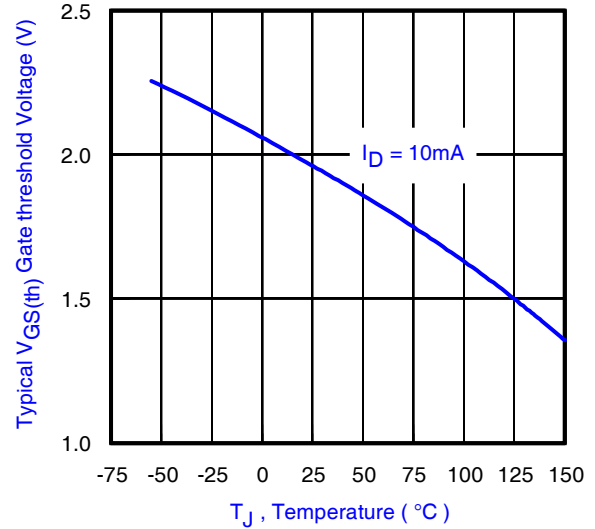

Fig 13. Typical Threshold Voltage vs. Junction Temperature

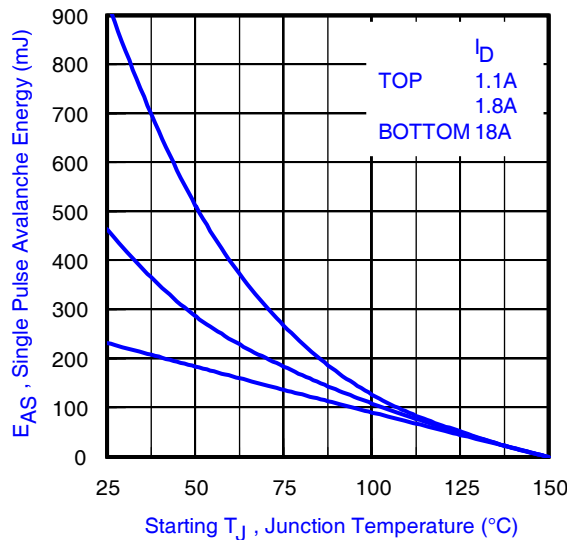

Fig 14. Maximum Avalanche Energy vs. Drain Current

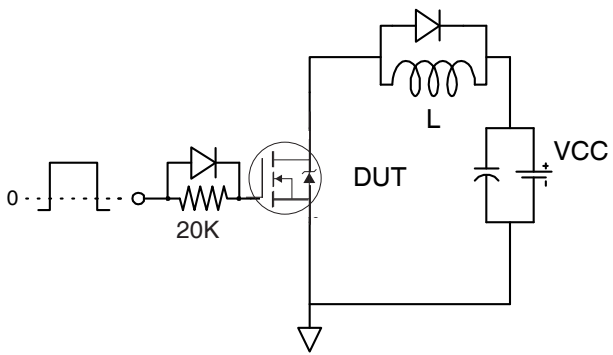

Fig 15a. Gate Charge Test Circuit

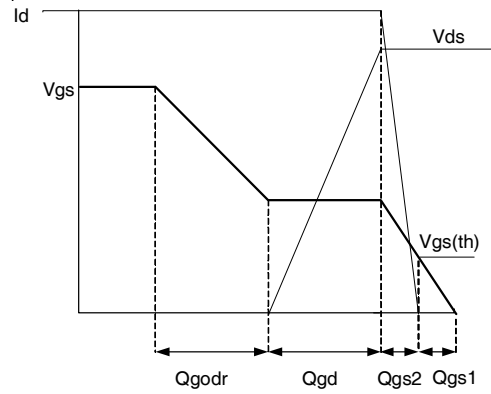

Fig 15b. Gate Charge Waveform

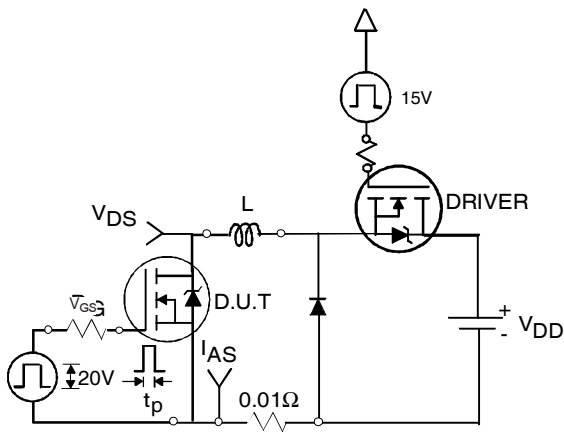

Fig 16a. Unclamped Inductive Test Circuit

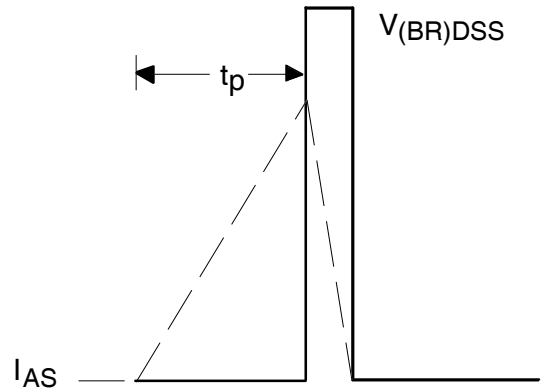

Fig 16b. Unclamped Inductive Waveforms

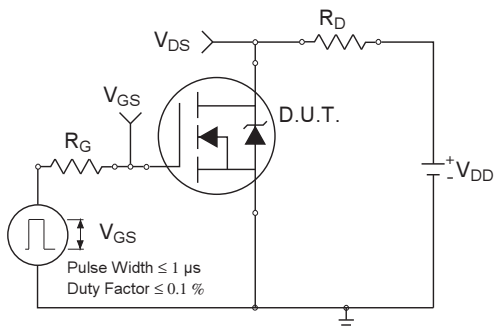

Fig 17a. Switching Time Test Circuit

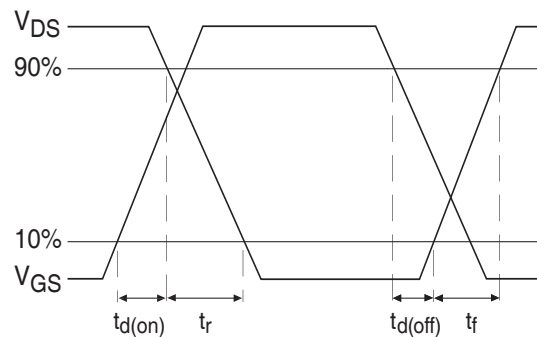
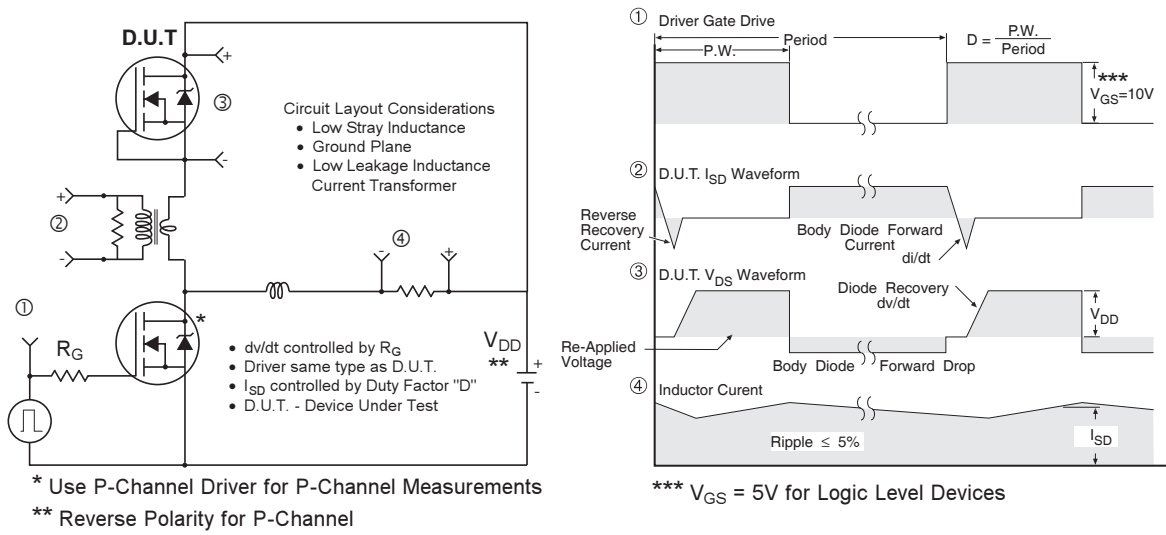

Fig 17b. Switching Time Waveforms



**Fig 18.** Diode Reverse Recovery Test Circuit for HEXFET® Power MOSFETs

**DirectFET™ Board Footprint, MX Outline (Medium Size Can, X-Designation).**

Please see DirectFET application note AN-1035 for all details regarding the assembly of DirectFET. This includes all recommendations for stencil and substrate designs.

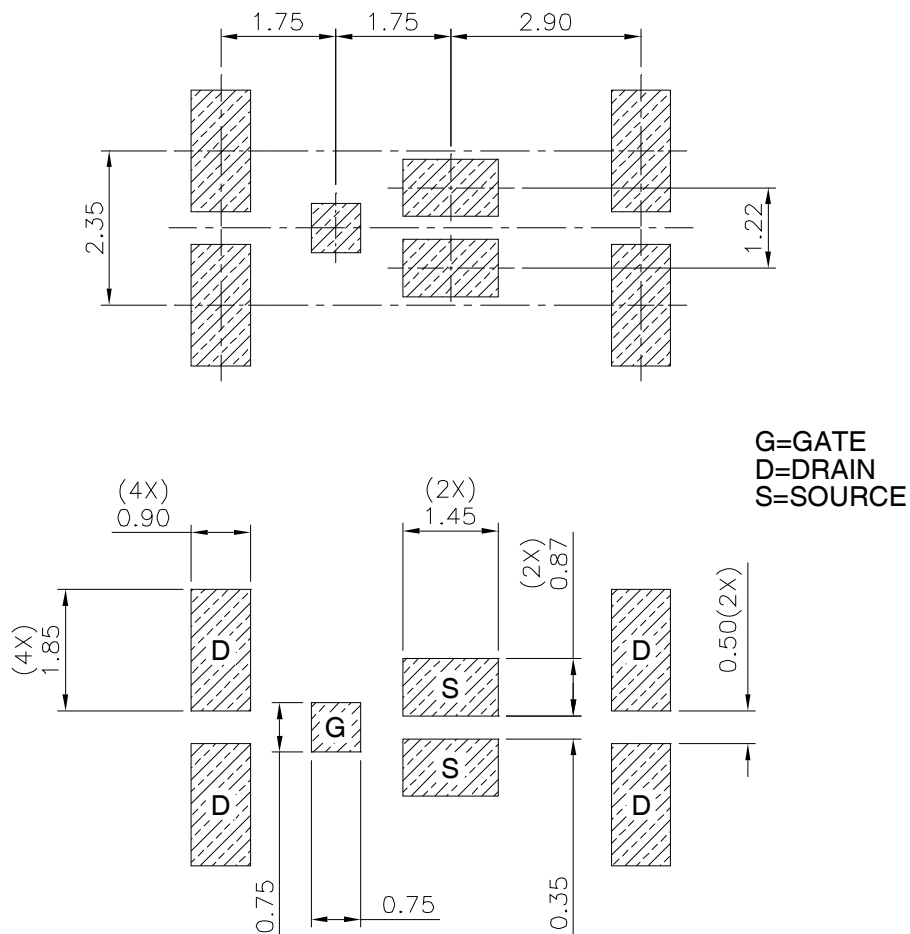

Note: For the most current drawing please refer to IR website at: <http://www.irf.com/package/>

**DirectFET™ Outline Dimension, MX Outline  
(Medium Size Can, X-Designation)**

Please see AN-1035 for DirectFET assembly details, stencil and substrate design recommendations

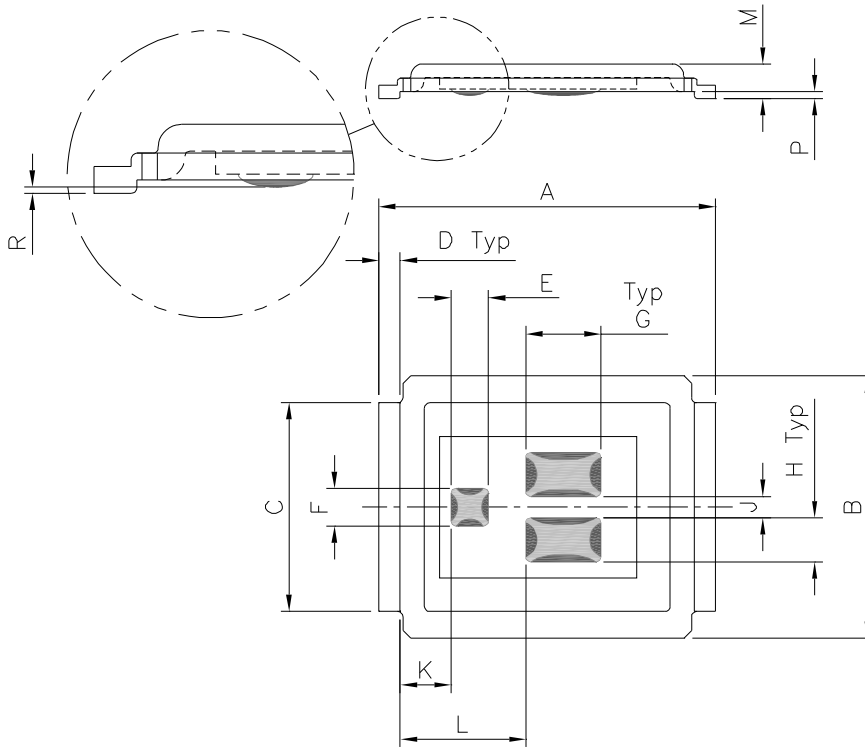

DIMENSIONS				
	METRIC		IMPERIAL	
CODE	MIN	MAX	MIN	MAX
A	6.25	6.35	0.246	0.250
B	4.80	5.05	0.189	0.199
C	3.85	3.95	0.152	0.156
D	0.35	0.45	0.014	0.018
E	0.68	0.72	0.027	0.028
F	0.68	0.72	0.027	0.028
G	1.38	1.42	0.054	0.056
H	0.80	0.84	0.031	0.033
J	0.38	0.42	0.015	0.017
K	0.88	1.02	0.035	0.040
L	2.28	2.42	0.090	0.095
M	0.59	0.70	0.023	0.028
R	0.03	0.08	0.001	0.003
P	0.08	0.17	0.003	0.007

Dimensions are shown in millimeters (inches)

**DirectFET™ Part Marking**

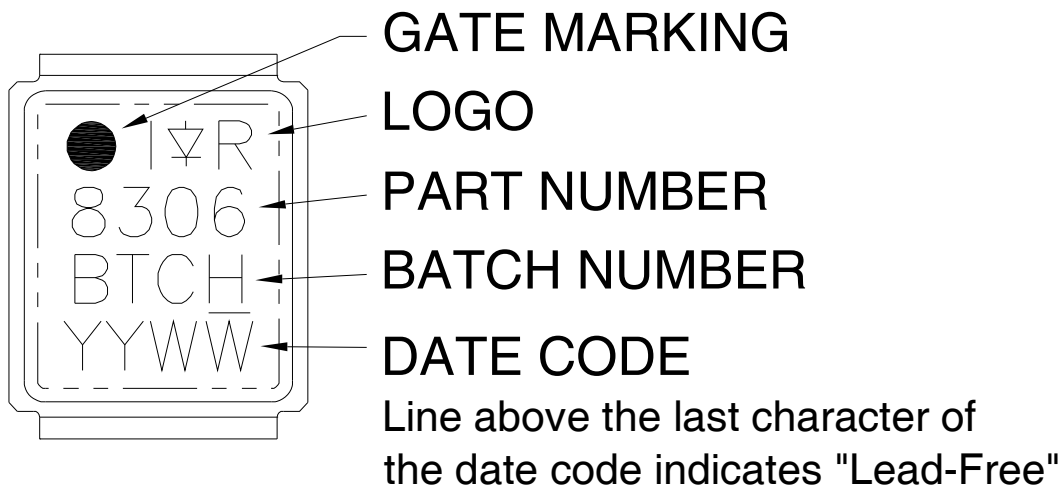

Note: For the most current drawing please refer to IR website at: <http://www.irf.com/package/>



DirectFET™ Tape & Reel Dimension (Showing component orientation).

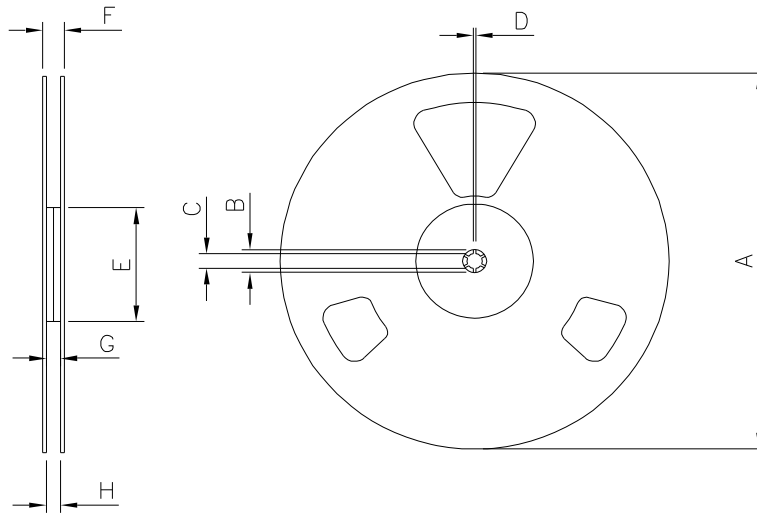

NOTE: Controlling dimensions in mm Std reel quantity is 4800 parts. (ordered as IRF8306MPBF).

REEL DIMENSIONS				
STANDARD OPTION(QTY 4800)				
CODE	METRIC		IMPERIAL	
	MIN	MAX	MIN	MAX
A	330.0	N.C	12.992	N.C
B	20.2	N.C	0.795	N.C
C	12.8	13.2	0.504	0.520
D	1.5	N.C	0.059	N.C
E	100.0	N.C	3.937	N.C
F	N.C	18.4	N.C	0.724
G	12.4	14.4	0.488	0.567
H	11.9	15.4	0.469	0.606

LOADED TAPE FEED DIRECTION

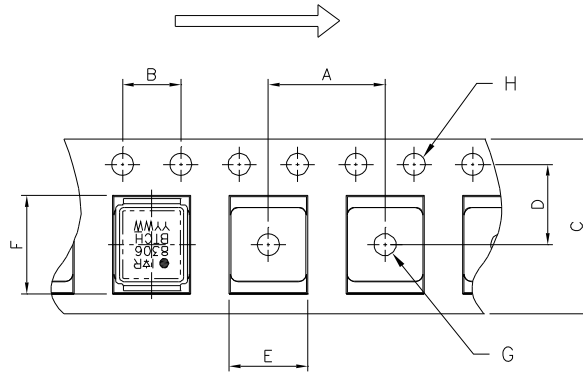

NOTE: CONTROLLING DIMENSIONS IN MM

CODE	METRIC		IMPERIAL	
	MIN	MAX	MIN	MAX
A	7.90	8.10	0.311	0.319
B	3.90	4.10	0.154	0.161
C	11.90	12.30	0.469	0.484
D	5.45	5.55	0.215	0.219
E	5.10	5.30	0.201	0.209
F	6.50	6.70	0.256	0.264
G	1.50	N.C	0.059	N.C
H	1.50	1.60	0.059	0.063

Note: For the most current drawing please refer to IR website at: <http://www.irf.com/package/>

**Qualification Information†**

Qualification level	Consumer ††	
	(per JEDEC JESD47F††† guidelines)	
	Comments: This family of products has passed JEDEC's Industrial qualification. IR's Consumer qualification level is granted by extension of the higher Industrial level.	
Moisture Sensitivity Level	DFET	MSL1 (per JEDEC J-STD-020D†††)
RoHS Compliant	Yes	

† Qualification standards can be found at International Rectifier's web site <http://www.irf.com/product-info/reliability>

†† Higher qualification ratings may be available should the user have such requirements. Please contact your International Rectifier sales representative for further information: <http://www.irf.com/whoto-call/salesrep/>

††† Applicable version of JEDEC standard at the time of product release.

**Revision History**

Date	Comments
5/7/2014	<ul style="list-style-type: none"> <li>• Updated ordering information to reflect the End-Of-life (EOL) of the mini-reel option (EOL notice #264).</li> <li>• Updated data sheet based on corporate template.</li> </ul>