



# PRODUCT SPECIFICATION

**Model No : CSM-58231B7/58241B7**

Descriptions:
<ul style="list-style-type: none"> <li>• 2.3 Inch 5X8 Dot-Matrix Display</li> <li>• Dot Pitch 7.62mm</li> <li>• CSM-58231: Column Anode, Row Cathode</li> <li>• CSM-58241: Column Cathode, Row Anode</li> <li>• Emitting Color: Super Bright Blue</li> </ul>



CUSTOMER APPROVED SIGNATURES	APPROVED BY	CHECKED BY	PREPARED BY

**CHINA SEMICONDUCTOR CORPORATION**  
Address: 2FL. NO.909, Chung-Cheng Road,  
Chung-Ho City Taipei Hsien, Taiwan.

Tel: 886-2-2223-9696  
Fax: 886-2-2223-9377

**OPTO PLUS TECHNOLOGIES CO.,LTD**  
Address: 696 Shun jiang Rd., Ji Shan St. Shaoxing,  
ZheJiang, China

Tel: 86-0575-8623888  
Fax: 86-0575-8623112



**Model No : CSM-58231/58241B7**

■ **Features -**

1. 2.3 inch (58.0mm) Matrix height.
2. Case mold type.
3. RoHs compliant.
4. Low power consumption.
5. Easy mounting on P.C. board or socket.

■ **Device Selection Guide -**

Part No.	Chip		Description	
	Material	Emitted Color	Column	Row
CSM-58231B7	InGaN	Super Bright Blue	Anode	Cathode
CSM-58241B7	InGaN	Super Bright Blue	Cathode	Anode

■ **Package Dimensions -**

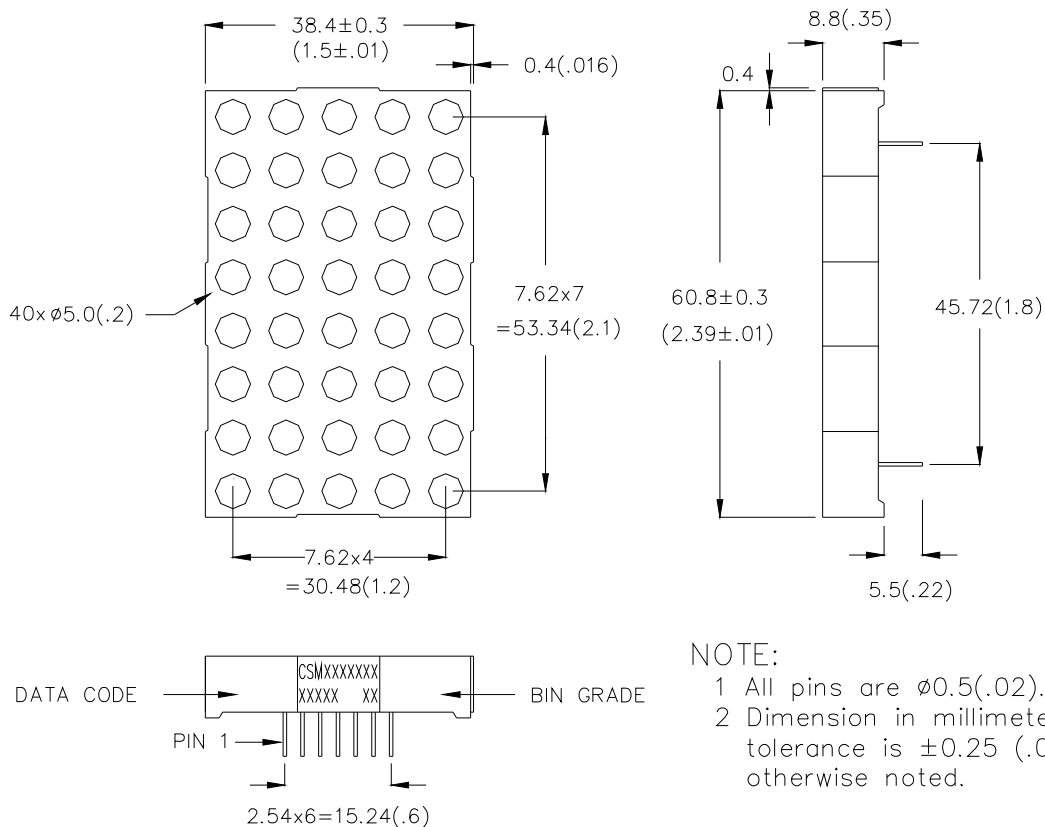

NOTE:

- 1 All pins are  $\phi 0.5$  (.02).
- 2 Dimension in millimeters (inch), tolerance is  $\pm 0.25$  (.01) unless otherwise noted.



Model No : CSM-58231/58241B7

Internal Circuit Diagrams -

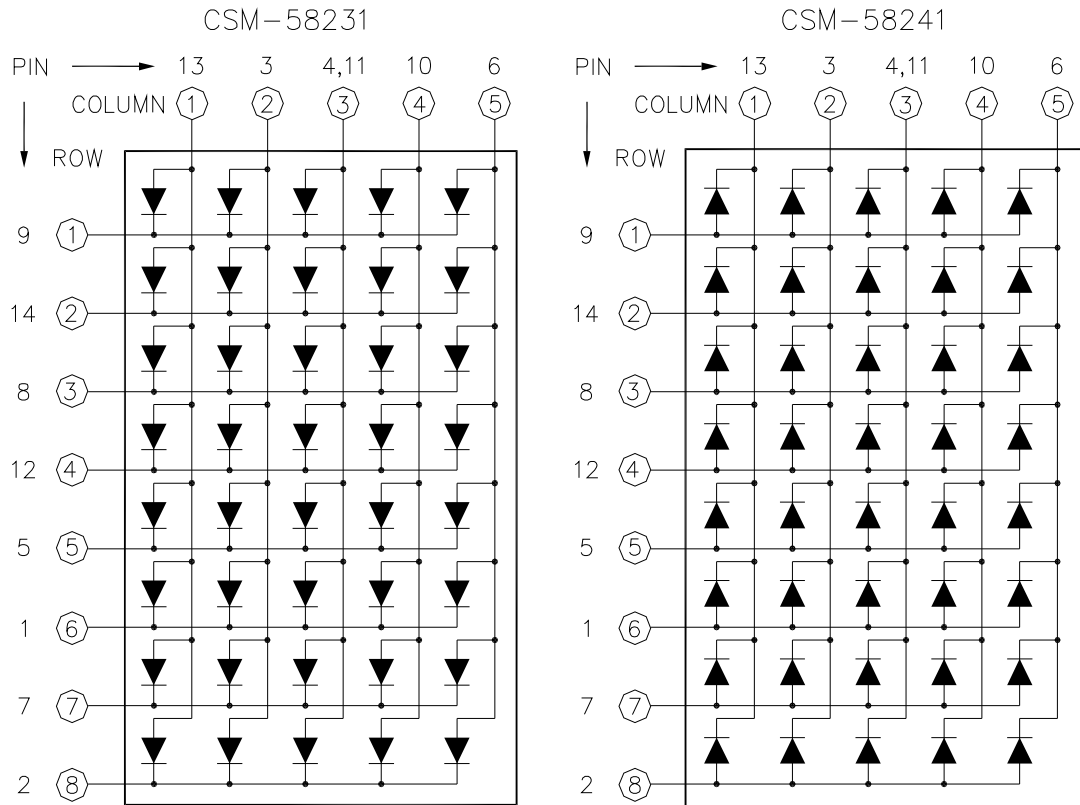

CSM-58231				CSM-58241			
PIN NO.	FUNCTION	PIN NO.	FUNCTION	PIN NO.	FUNCTION	PIN NO.	FUNCTION
1	Cathode Row 6	8	Cathode Row 3	1	Anode Row 6	8	Anode Row 3
2	Cathode Row 9	9	Cathode Row 1	2	Anode Row 9	9	Anode Row 1
3	Anode Column 2	10	Anode Column 4	3	Cathode Column 2	10	Cathode Column 4
4	Anode Column 3	11	Anode Column 3	4	Cathode Column 3	11	Cathode Column 3
5	Cathode Row 5	12	Cathode Row 4	5	Anode Row 5	12	Anode Row 4
6	Anode Column 5	13	Anode Column 1	6	Cathode Column 5	13	Cathode Column 1
7	Cathode Row 7	14	Cathode Row 2	7	Anode Row 7	14	Anode Row 2



Model No : CSM-58231/58241B7

■ Absolute Maximum Rating -

(Ta=25°C)

Parameter	Symbol	Rating	Unit
Power Dissipation Per Dice	<b>Pd</b>	120	mW
Continuous Forward Current Per Dice	<b>IAF</b>	30	mA
Peak Current Per Dice(duty cycle 1/10, 1kHz)	<b>IPF</b>	100	mA
Derating Linear From 25°C Per Dice	-	0.4	mA/°C
Reverse Voltage Per Dice	<b>VR</b>	5	V
Operating Temp.	<b>Topr</b>	-35 ~ +85	°C
Storage Temp.	<b>Tstg</b>	-35 ~ +85	°C
Solder temperature 1/16 inch below seating plane for 3 seconds at 260°C			

■ Electro-optical Characteristics -

(Ta=25°C)

Parameter	Symbol	Min.	Typ.	Max.	Unit	Condition
Forward Voltage Per Segment	<b>VF</b>	-	3.2	4	V	IF=20mA
Luminous Intensity Per Segment	<b>Iv</b>	-	35	-	mcd	IF=10mA
Dominant Wavelength	<b>λd</b>	-	470	-	nm	IF=20mA
Spectrum Radiation Bandwidth	<b>Δλ</b>	-	30	-	nm	IF=20mA
Reverse Current	<b>IR</b>	-	-	50	μA	VR=5V
Luminous Intensity Matching Ratio	<b>IV-m</b>	-	-	2:1	-	IF=10mA



Model No : CSM-58231/58241B7

■ Typical Electrical / Optical Characteristics Curves -

(Ta = 25°C Unless Otherwise Noted)

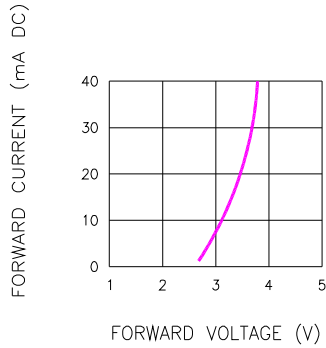

Fig.1 FORWARD CURRENT VS. FORWARD VOLTAGE

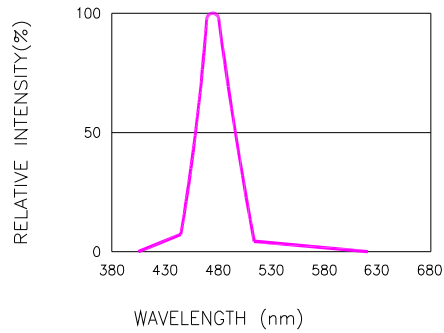

Fig.2 RELATIVE INTENSITY VS. WAVELENGTH

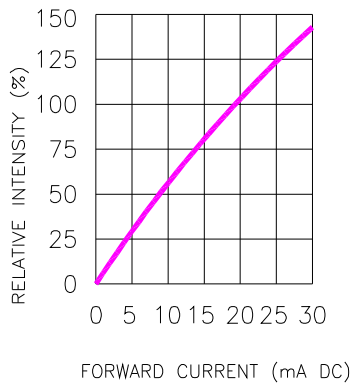

Fig.3 RELATIVE INTENSITY VS. FORWARD CURRENT

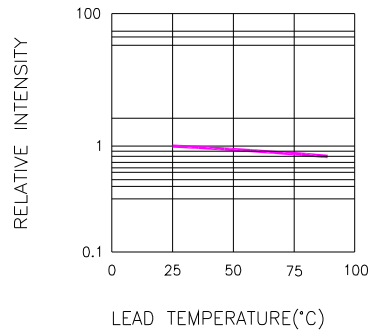

Fig.4 RELATIVE INTENSITY VS. LEAD TEMPERATURE  
(PULSED 20 mA; 300us  
PULSE, 10ms PERIOD)

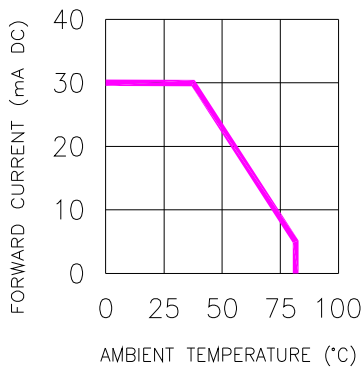

Fig.5 FORWARD CURRENT VS. AMBIENT TEMPERATURE

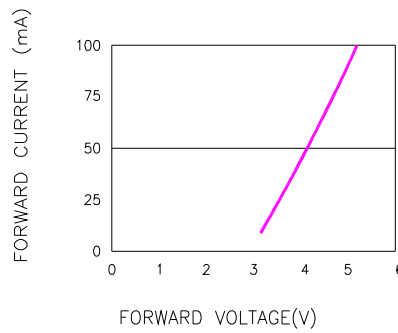

Fig.6 PEAK FORWARD VOLTAGE VS. FORWARD(100us TEST PULSE,  
1% DUTY CYCLE)