

20V P-Channel Enhancement-Mode MOSFET

$V_{DS} = -20V$

$R_{DS(ON)}, V_{GS}@-4.5V, I_{DS}@-2.8A = 100\ m\Omega$

$R_{DS(ON)}, V_{GS}@-2.5V, I_{DS}@-2.0A = 150\ m\Omega$

Features

Advanced trench process technology

High Density Cell Design For Ultra Low On-Resistance

Fully Characterized Avalanche Voltage and Current

Improved Shoot-Through FOM

we declare that the material of product compliance with RoHS requirements.

▼ Simple Drive Requirement

▼ Small Package Outline

▼ Surface Mount Device

LP2301BLT1G

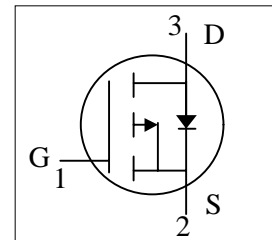
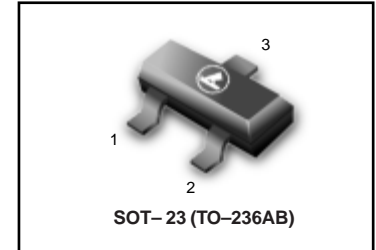

Ordering Information

Device	Marking	Shipping
LP2301BLT1G	0B	3000/Tape & Reel
LP2301BLT3G	0B	10,000/Tape & Reel

Maximum Ratings and Thermal Characteristics ($T_A = 25^\circ C$ unless otherwise noted)

Parameter	Symbol	Limit	Unit	
Drain-Source Voltage	V_{DS}	-20	V	
Gate-Source Voltage	V_{GS}	± 8		
Continuous Drain Current	I_D	-2.8	A	
Pulsed Drain Current 1)	I_{DM}	-8		
Maximum Power Dissipation	P_D	$T_A = 25^\circ C$	0.9	W
		$T_A = 75^\circ C$	0.57	
Operating Junction and Storage Temperature Range	T_J, T_{stg}	-55 to 150	$^\circ C$	
Junction-to-Case Thermal Resistance	R_{qJC}		$^\circ C/W$	
Junction-to-Ambient Thermal Resistance (PCB mounted) 2)	R_{qJA}	140		

Note: 1. Repetitive Rating; Pulse width limited by the Maximum junction temperature

2. 1-in² 2oz Cu PCB board

3. Guaranteed by design; not subject to production testing

LP2301BLT1G

ELECTRICAL CHARACTERISTICS

Parameter	Symbol	Test Condition	Min	Typ	Max	Unit
Static						
Drain-Source Breakdown Voltage	BV_{DSS}	$V_{GS} = 0V, I_D = -250\mu A$	-20	-	-	V
Drain-Source On-State Resistance	$R_{DS(on)}$	$V_{GS} = -4.5V, I_D = -2.8A$		69	100	m Ω
Drain-Source On-State Resistance	$R_{DS(on)}$	$V_{GS} = -2.5V, I_D = -2.0A$		83	150	m Ω
Gate Threshold Voltage	$V_{GS(th)}$	$V_{DS} = V_{GS}, I_D = -250\mu A$	-0.40		-0.90	V
Zero Gate Voltage Drain Current	I_{DSS}	$V_{DS} = -9.6V, V_{GS} = 0V$			-1	μA
Gate Body Leakage	I_{GSS}	$V_{GS} = \pm 8V, V_{DS} = 0V$			± 100	nA
Gate Resistance	R_g					Ω
Forward Transconductance	g_{fs}	$V_{DS} = -5V, I_D = -4.0A$		6.5		S
Dynamic ³⁾						
Total Gate Charge	Q_g	$V_{DS} = -6V, I_D = -2.8A$ $V_{GS} = -4.5V$		15.23		nC
Gate-Source Charge	Q_{gs}			5.49		
Gate-Drain Charge	Q_{gd}			2.74		
Turn-On Delay Time	$t_{d(on)}$	$V_{DD} = -6V, R_L = 6\Omega$ $I_D = -1A, V_{GEN} = -4.5V$ $R_G = 6\Omega$		17.28		ns
Turn-On Rise Time	t_r			3.73		
Turn-Off Delay Time	$t_{d(off)}$			36.05		
Turn-Off Fall Time	t_f			6.19		
Input Capacitance	C_{iss}	$V_{DS} = -6V, V_{GS} = 0V$ $f = 1.0\text{ MHz}$		882.51		pF
Output Capacitance	C_{oss}			145.54		
Reverse Transfer Capacitance	C_{rss}			97.26		
Source-Drain Diode						
Max. Diode Forward Current	I_S				-2.4	A
Diode Forward Voltage	V_{SD}	$I_S = -0.75A, V_{GS} = 0V$		-0.8	-1.2	V

Note: Pulse test: pulse width $\leq 300\mu s$, duty cycle $\leq 2\%$

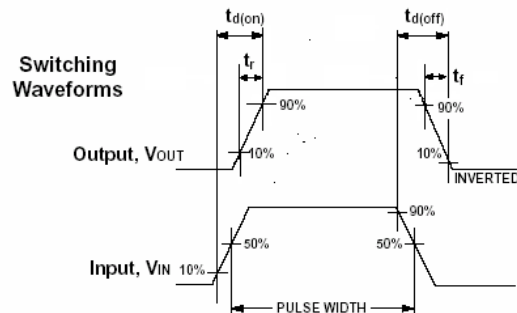
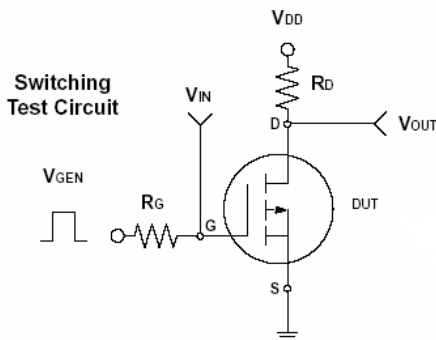

LP2301BLT1G

TYPICAL ELECTRICAL CHARACTERISTICS

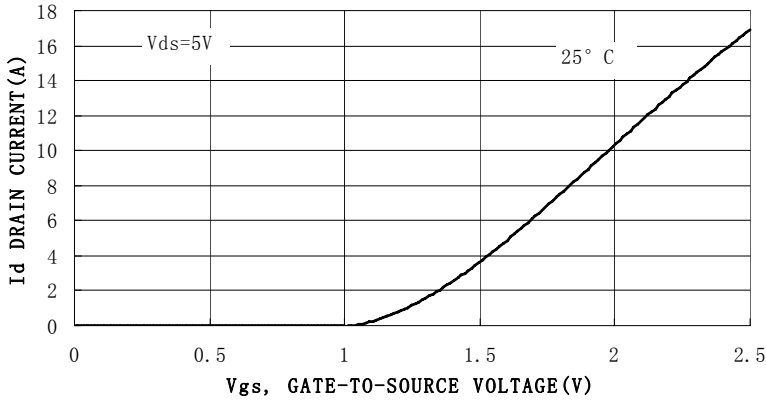

Figure 1. Transfer Characteristics

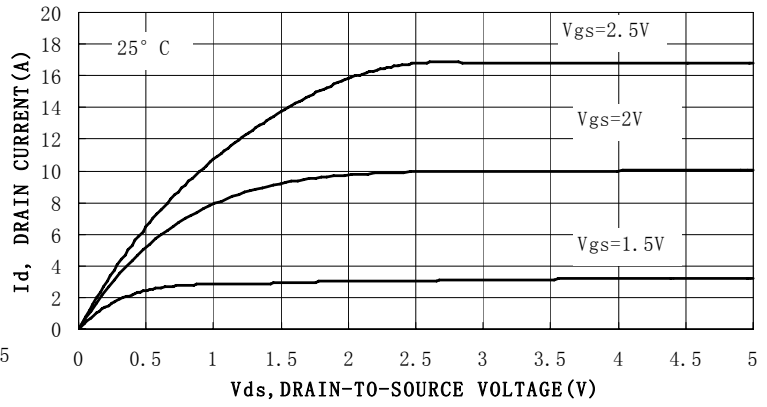

Figure 2. On-Region Characteristics

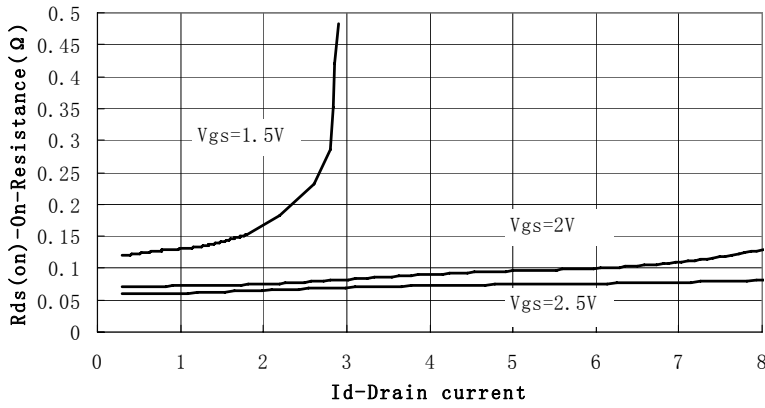

Figure 3. On-Resistance versus Drain Current

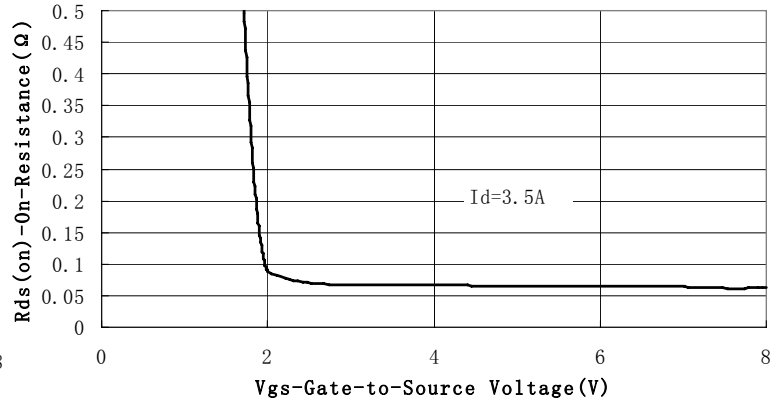

Figure 4. On-Resistance vs. Gate-to-Source Voltage

LP2301BLT1G

TYPICAL ELECTRICAL CHARACTERISTICS

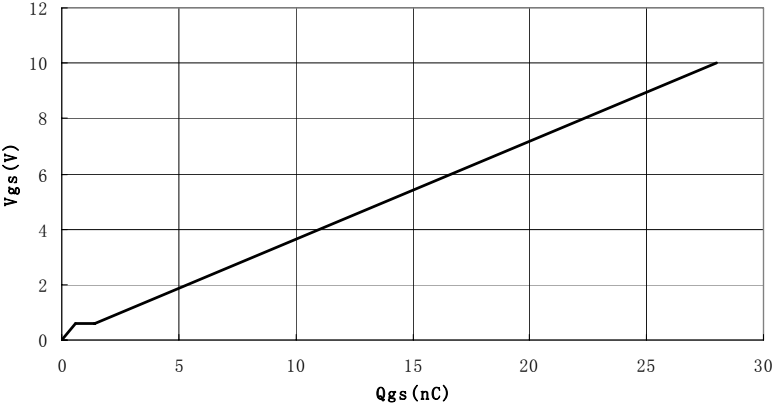

Figure 5. Gate Charge

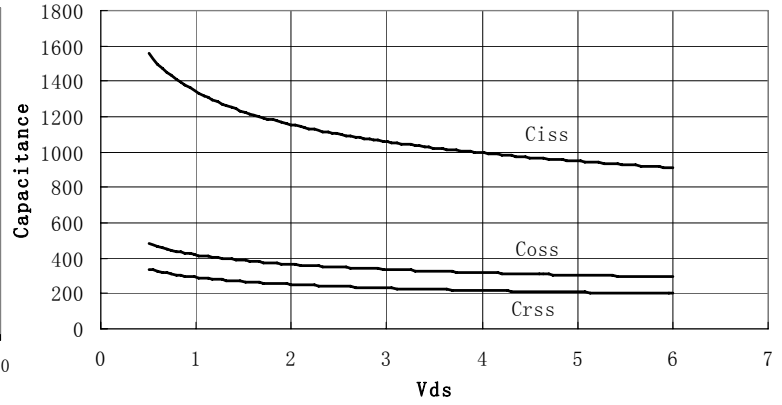

Figure 6. Capacitance

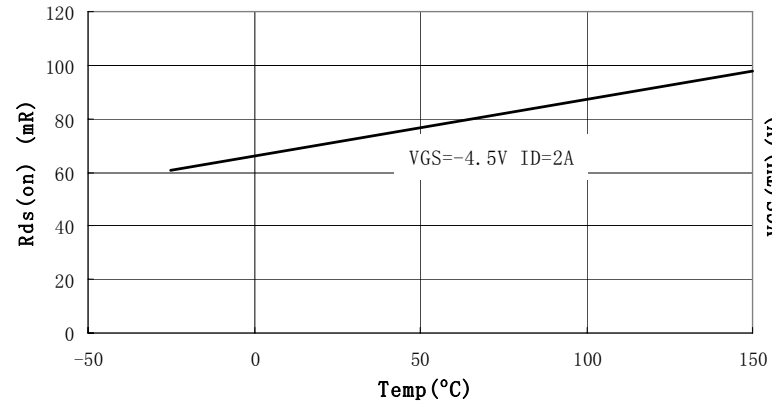

Figure 7. On-Resistance Vs. Junction Temperature

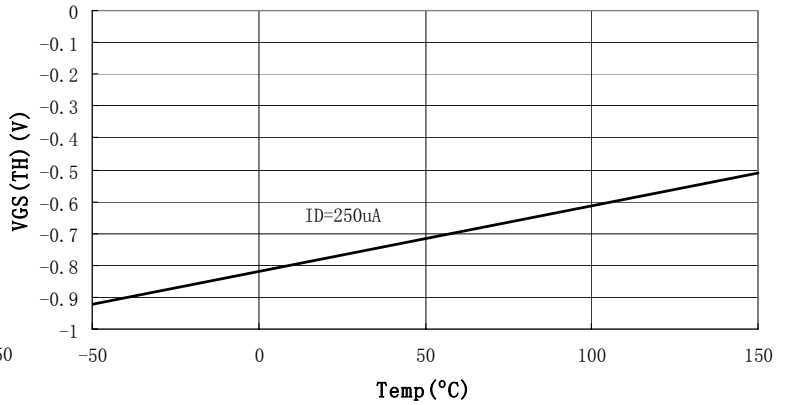

Figure 8. Vth Vs. Junction Temperature

LP2301BLT1G

SOT-23

NOTES:

1. DIMENSIONING AND TOLERANCING PER ANSI Y14.5M,1982
2. CONTROLLING DIMENSION: INCH.

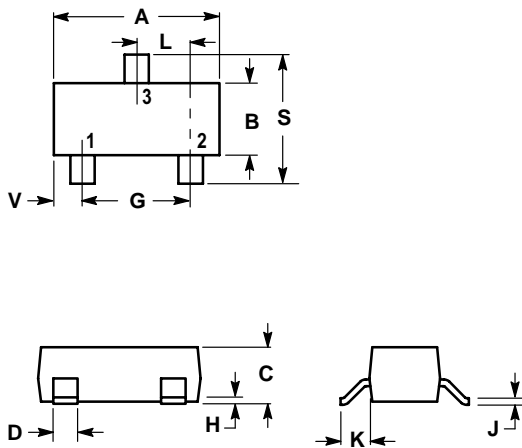

DIM	INCHES		MILLIMETERS	
	MIN	MAX	MIN	MAX
A	0.1102	0.1197	2.80	3.04
B	0.0472	0.0551	1.20	1.40
C	0.0350	0.0440	0.89	1.11
D	0.0150	0.0200	0.37	0.50
G	0.0701	0.0807	1.78	2.04
H	0.0005	0.0040	0.013	0.100
J	0.0034	0.0070	0.085	0.177
K	0.0140	0.0285	0.35	0.69
L	0.0350	0.0401	0.89	1.02
S	0.0830	0.1039	2.10	2.64
V	0.0177	0.0236	0.45	0.60

