

MSR1560G, MSRF1560G

Switch-mode Soft Recovery Power Rectifier

These state-of-the-art devices are designed for boost converter or hard-switched converter applications, especially for Power Factor Correction application. It could also be used as a free wheeling diode in variable speed motor control applications and switching mode power supplies.

Features

- Soft Recovery with Low Reverse Recovery Charge (Q_{RR}) and Peak Reverse Recovery Current (I_{RRM})
- Epoxy meets UL 94 V-0 @ 0.125 in
- Low Forward Voltage
- Low Leakage Current
- High Temperature Glass Passivated Junction
- These are Pb-Free Devices

Mechanical Characteristics:

- Case: Epoxy, Molded
- Weight: 1.9 Grams (Approximately)
- Finish: All External Surfaces Corrosion Resistant and Terminal Leads Readily Solderable
- Lead Temperature for Soldering Purposes: 260°C Max. for 10 Seconds

MAXIMUM RATINGS

Rating	Symbol	Value	Unit
Peak Repetitive Reverse Voltage Working Peak Reverse Voltage DC Blocking Voltage	V_{RRM} V_{RWM} V_R	600	V
Average Rectified Forward Current (At Rated V_R , $T_C = 125^\circ\text{C}$)	I_O	15	A
Peak Repetitive Forward Current (At Rated V_R , Square Wave, 20 kHz, $T_C = 125^\circ\text{C}$)	I_{FRM}	30	A
Non-Repetitive Peak Surge Current (Surge applied at rated load conditions, halfwave, single phase, 60 Hz)	I_{FSM}	100	A
Operating Junction and Storage Temperature Range	T_J, T_{stg}	-65 to +150	$^\circ\text{C}$

THERMAL CHARACTERISTICS

Parameter	Symbol	Value	Unit
MSR1560G: Thermal Resistance Junction-to-Case Junction-to-Ambient	$R_{\theta JC}$ $R_{\theta JA}$	1.6 72.8	$^\circ\text{C}/\text{W}$
MSRF1560G: Thermal Resistance Junction-to-Case Junction-to-Ambient	$R_{\theta JC}$ $R_{\theta JA}$	4.25 75	$^\circ\text{C}/\text{W}$

Stresses exceeding those listed in the Maximum Ratings table may damage the device. If any of these limits are exceeded, device functionality should not be assumed, damage may occur and reliability may be affected.



ON Semiconductor®

<http://onsemi.com>

SOFT RECOVERY POWER RECTIFIER 15 AMPERES, 600 VOLTS

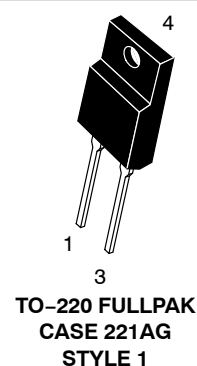
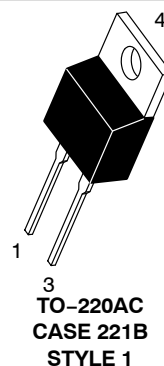
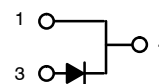

MARKING DIAGRAMS

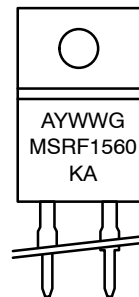
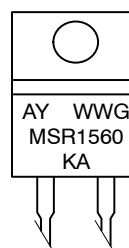

- A = Assembly Location
- Y = Year
- WW = Work Week
- G = Pb-Free Package
- KA = Diode Polarity

ORDERING INFORMATION

Device	Package	Shipping
MSR1560G	TO-220AC (Pb-Free)	50 Units/Rail
MSRF1560G	TO-220FP (Pb-Free)	50 Units/Rail

MSR1560G, MSRF1560G

ELECTRICAL CHARACTERISTICS

Characteristic	Symbol	Value		Unit
		$T_J = 25^\circ\text{C}$	$T_J = 150^\circ\text{C}$	
Instantaneous Forward Voltage (Note 1) ($I_F = 15\text{ A}$) Maximum Typical	V_F	$T_J = 25^\circ\text{C}$ 1.8 1.5	$T_J = 150^\circ\text{C}$ 1.4 1.2	V
		Instantaneous Reverse Current ($V_R = 600\text{ V}$) Maximum Typical	I_R	
Reverse Recovery Time (Note 2) ($V_R = 30\text{ V}$, $I_F = 1\text{ A}$, $di/dt = 100\text{ A}/\mu\text{s}$) Maximum Typical	t_{rr}	$T_J = 25^\circ\text{C}$ 45 35	$T_J = 100^\circ\text{C}$ 65 54	ns
		Typical Recovery Softness Factor ($V_R = 30\text{ V}$, $I_F = 1\text{ A}$, $di/dt = 100\text{ A}/\mu\text{s}$)	$s = t_b/t_a$	
Typical Peak Reverse Recovery Current ($V_R = 30\text{ V}$, $I_F = 1\text{ A}$, $di/dt = 100\text{ A}/\mu\text{s}$)	I_{RRM}	2.3	3.2	A
Typical Reverse Recovery Charge ($V_R = 30\text{ V}$, $I_F = 1\text{ A}$, $di/dt = 100\text{ A}/\mu\text{s}$)	Q_{RR}	31	78	nC

Product parametric performance is indicated in the Electrical Characteristics for the listed test conditions, unless otherwise noted. Product performance may not be indicated by the Electrical Characteristics if operated under different conditions.

1. Pulse Test: Pulse Width $\leq 380\ \mu\text{s}$, Duty Cycle $\leq 2\%$
2. T_{RR} measured projecting from 25% of I_{RRM} to zero current

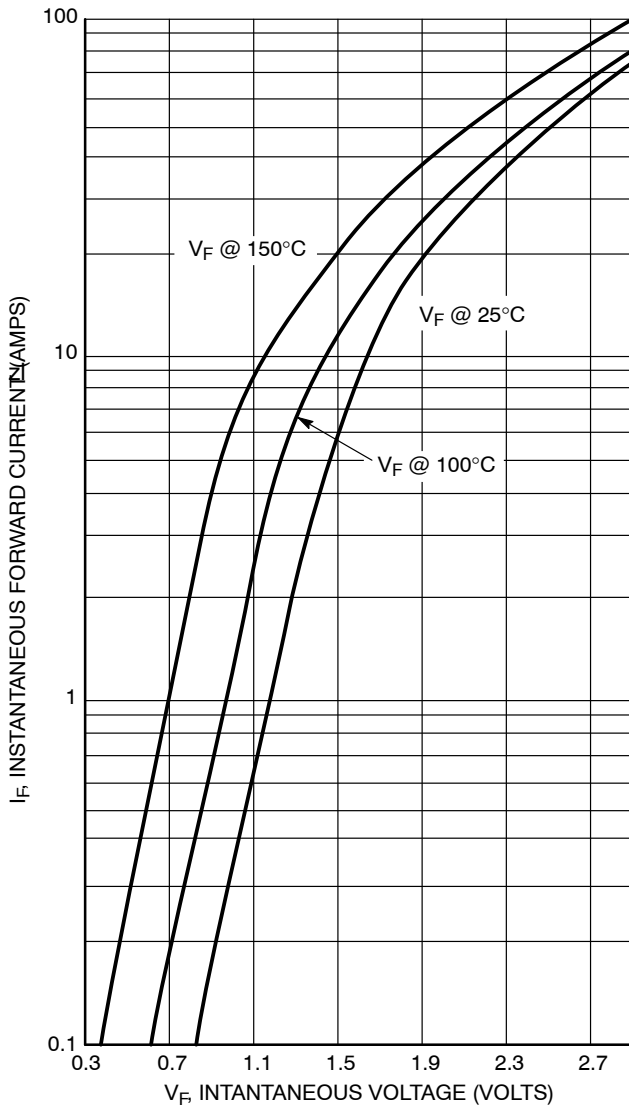

Figure 1. Maximum Forward Voltage

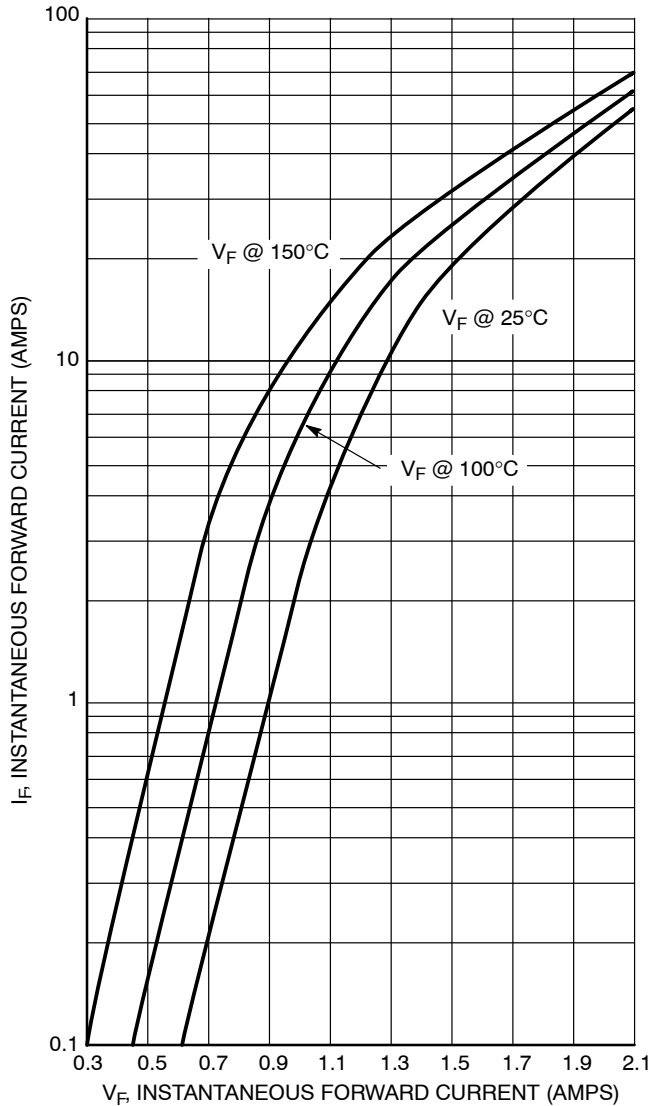

Figure 2. Typical Forward Voltage

MSR1560G, MSRF1560G

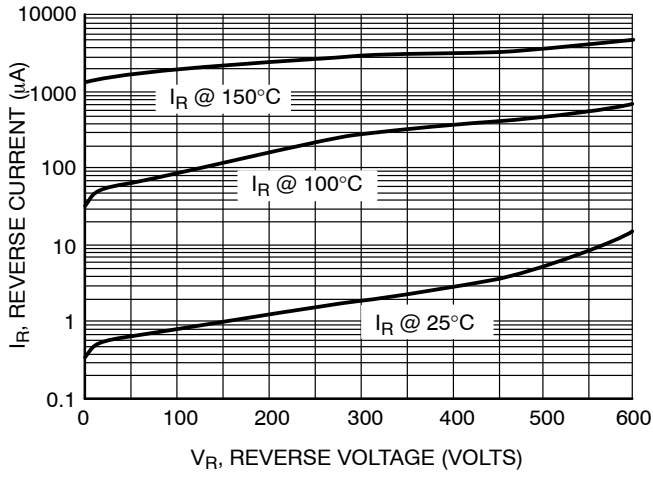

Figure 3. Maximum Reverse Current

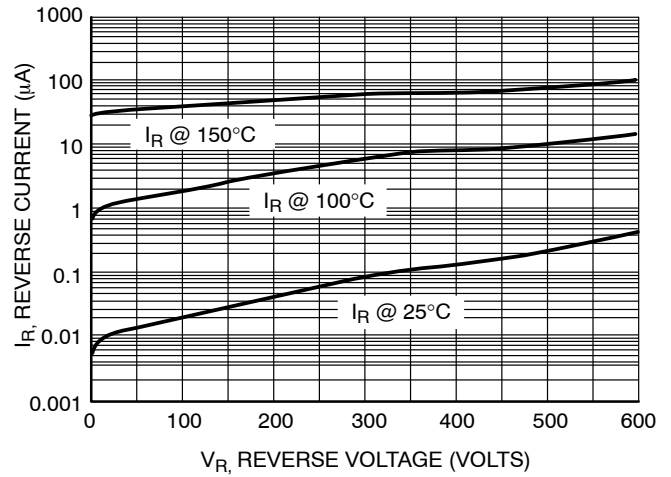

Figure 4. Typical Reverse Current

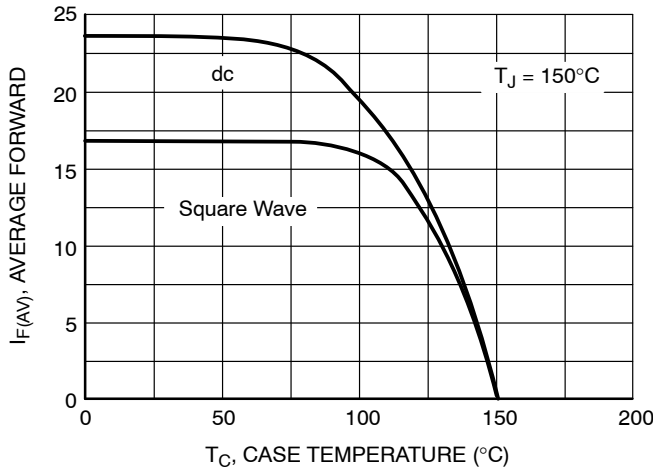

Figure 5. Current Derating

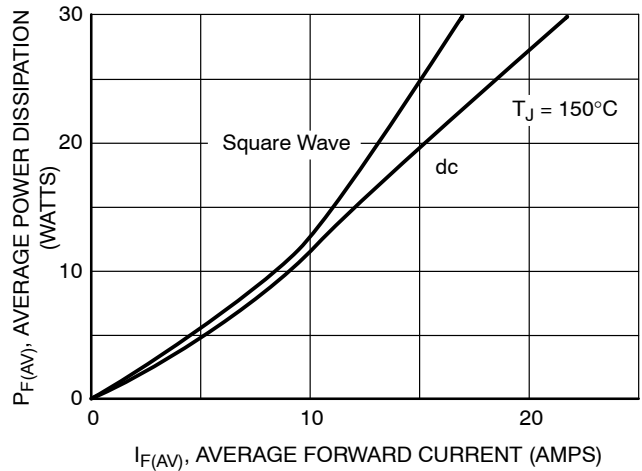

Figure 6. Power Dissipation

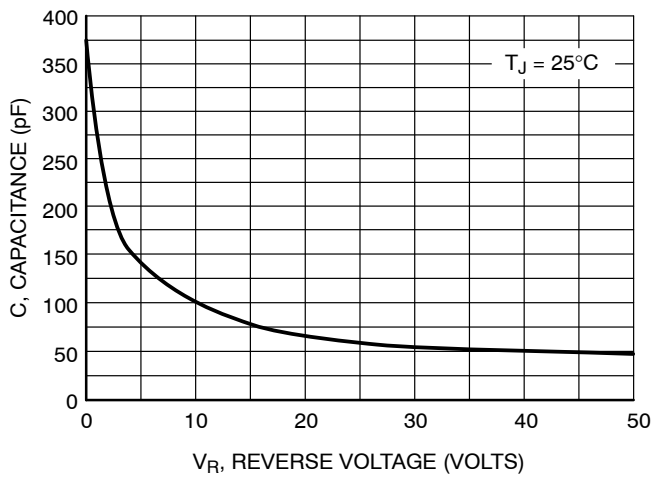

Figure 7. Maximum Capacitance

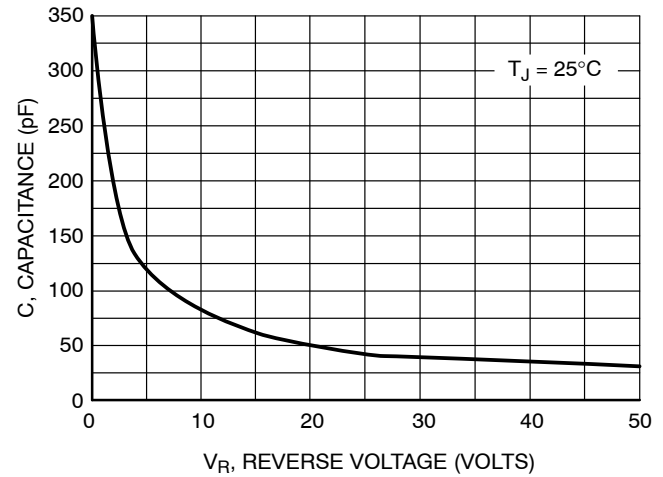

Figure 8. Typical Capacitance

MSR1560G, MSRF1560G

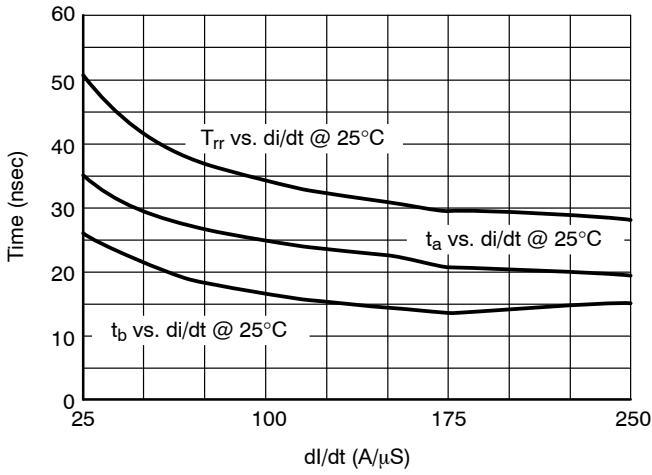

Figure 9. Typical Trr vs. di/dt

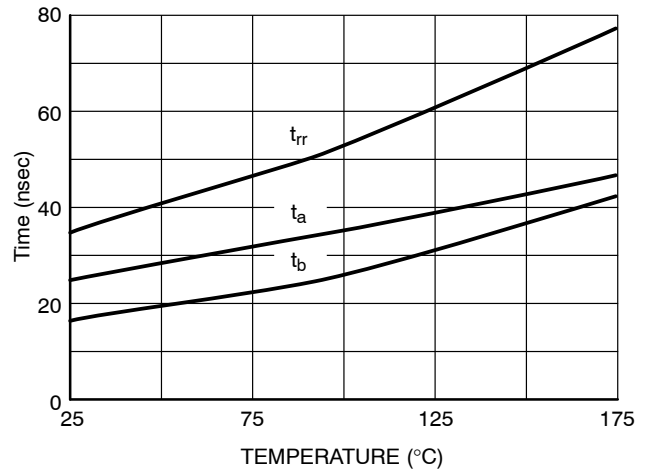

Figure 10. Typical Trr vs. Temperature

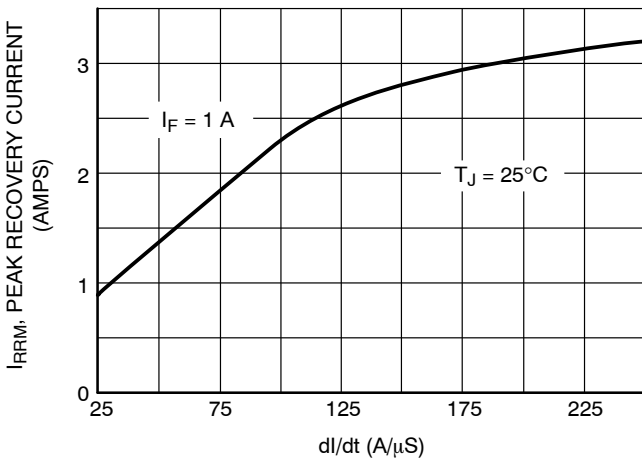

Figure 11. Typical Peak Reverse Recovery Current

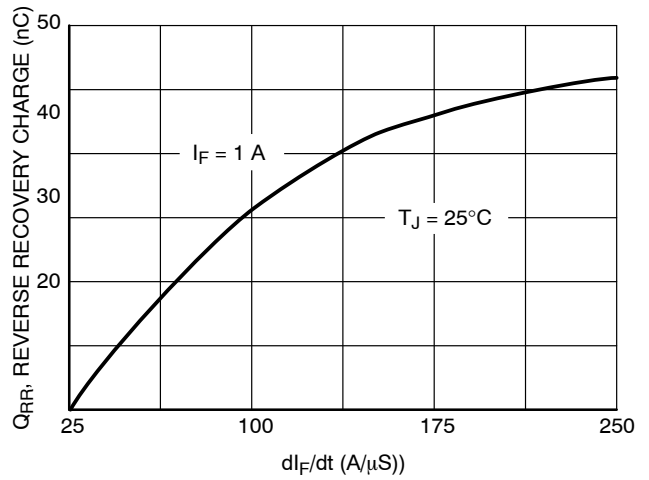

Figure 12. Typical Reverse Recovery Charge

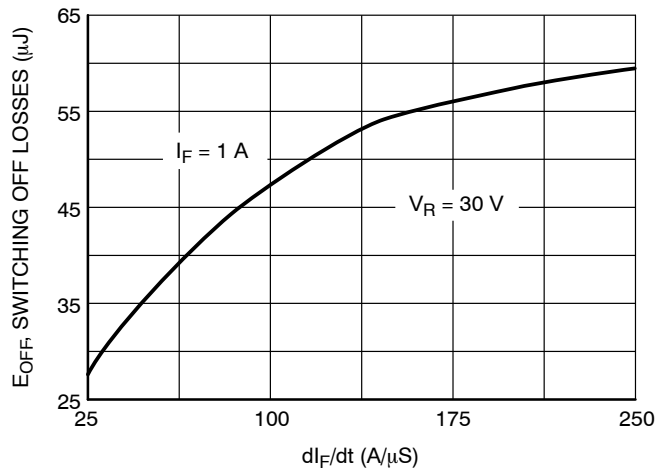

Figure 13. Typical Switching Off Losses

MSR1560G, MSRF1560G

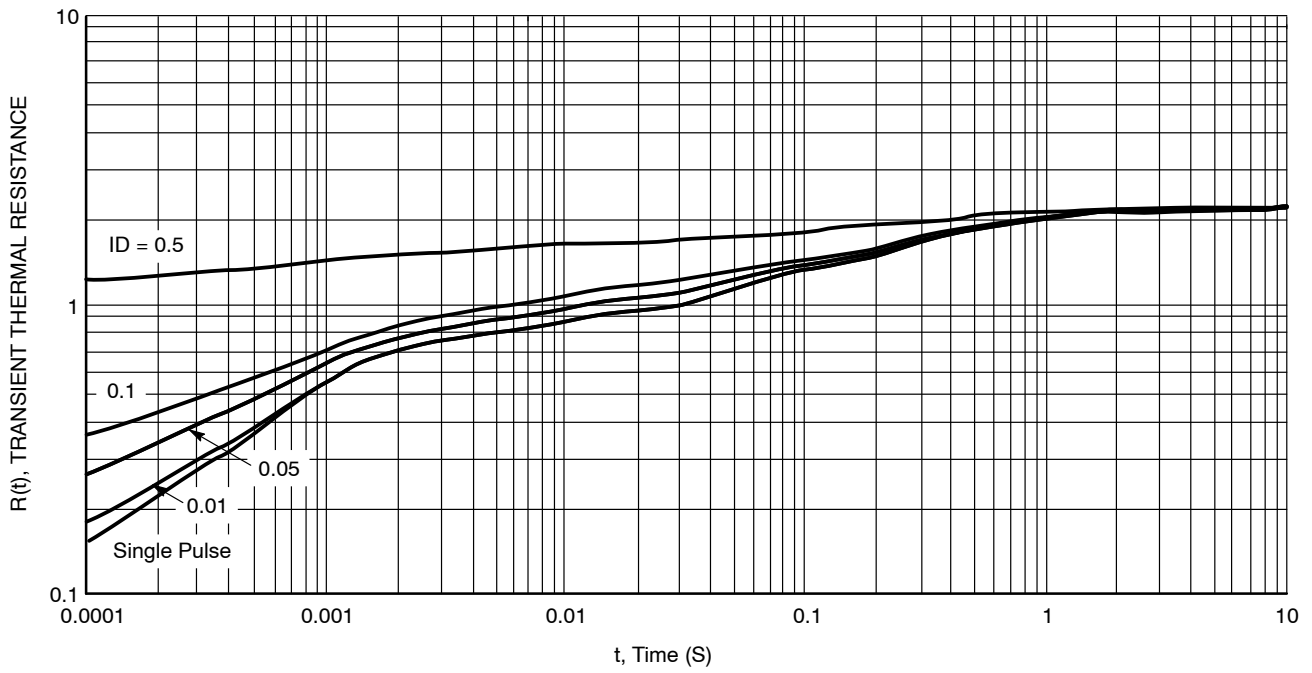

Figure 14. Transient Thermal Response

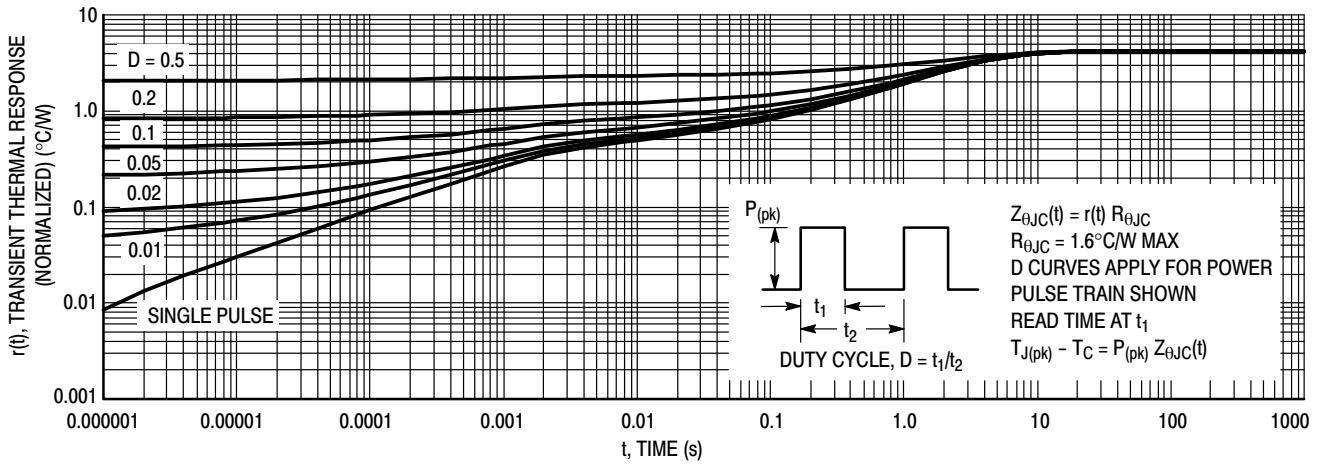

Figure 15. Thermal Response, (MSRF1560) Junction-to-Case ($R_{\theta JC}$)

MSR1560G, MSRF1560G

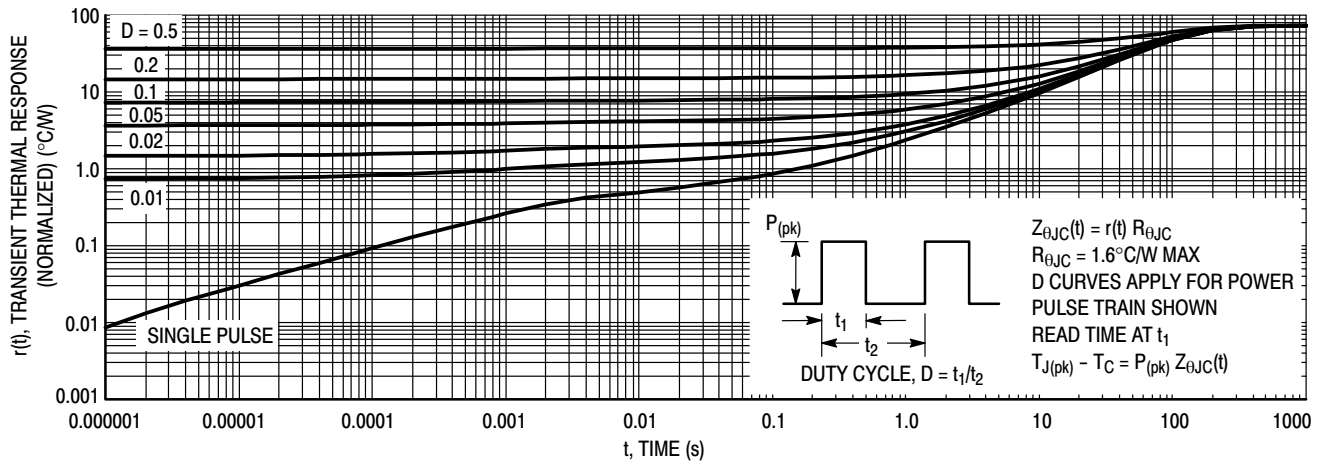
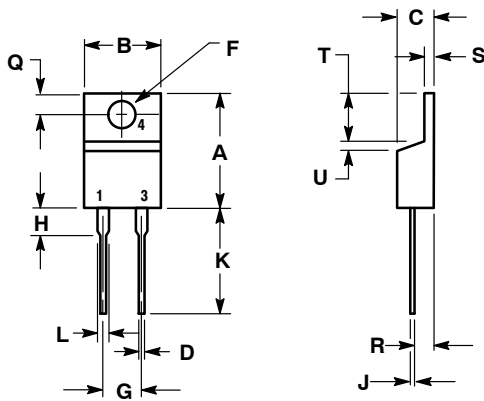

Figure 16. Thermal Response, (MSRF1560) Junction-to-Ambient ($R_{\theta JA}$)

MSR1560G, MSRF1560G

PACKAGE DIMENSIONS

TO-220 TWO-LEAD CASE 221B-04 ISSUE F



- NOTES:
1. DIMENSIONING AND TOLERANCING PER ANSI Y14.5M, 1982.
2. CONTROLLING DIMENSION: INCH.

DIM	INCHES		MILLIMETERS	
	MIN	MAX	MIN	MAX
A	0.595	0.620	15.11	15.75
B	0.380	0.405	9.65	10.29
C	0.160	0.190	4.06	4.82
D	0.025	0.039	0.64	1.00
F	0.142	0.161	3.61	4.09
G	0.190	0.210	4.83	5.33
H	0.110	0.130	2.79	3.30
J	0.014	0.025	0.36	0.64
K	0.500	0.562	12.70	14.27
L	0.045	0.060	1.14	1.52
Q	0.100	0.120	2.54	3.04
R	0.080	0.110	2.04	2.79
S	0.045	0.055	1.14	1.39
T	0.235	0.255	5.97	6.48
U	0.000	0.050	0.000	1.27

- STYLE 1:
PIN 1. CATHODE
2. N/A
3. ANODE
4. CATHODE

TO-220 FULLPAK, 2-LEAD CASE 221AG ISSUE A

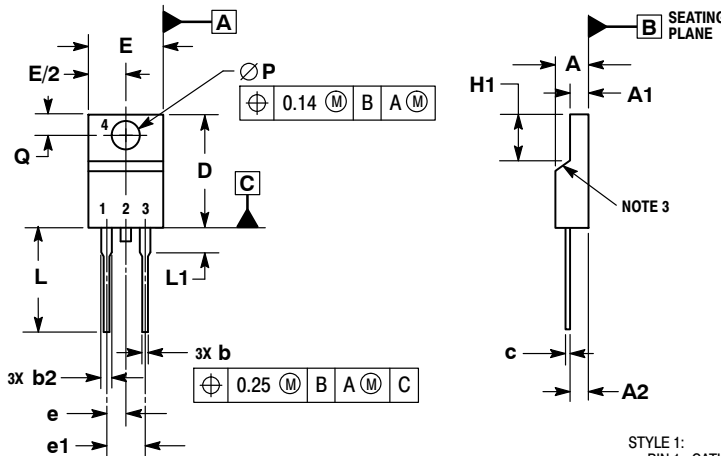

- NOTES:
1. DIMENSIONING AND TOLERANCING PER ASME Y14.5M, 1994.
2. CONTROLLING DIMENSION: MILLIMETERS.
3. CONTOUR UNCONTROLLED IN THIS AREA.
4. DIMENSIONS D AND E DO NOT INCLUDE MOLD FLASH AND GATE PROTRUSIONS. MOLD FLASH AND GATE PROTRUSIONS NOT TO EXCEED 0.13 PER SIDE. THESE DIMENSIONS ARE TO BE MEASURED AT OUTERMOST EXTREME OF THE PLASTIC BODY.
5. DIMENSION b2 DOES NOT INCLUDE DAMBAR PROTRUSION. LEAD WIDTH INCLUDING PROTRUSION SHALL NOT EXCEED 2.00.

DIM	MILLIMETERS	
	MIN	MAX
A	4.30	4.70
A1	2.50	2.90
A2	2.50	2.90
b	0.54	0.84
b2	1.10	1.40
c	0.49	0.79
D	14.22	15.88
E	9.65	10.67
e	2.54 BSC	
e1	5.08 BSC	
H1	5.97	6.48
L	12.70	14.73
L1	---	2.80
P	3.00	3.40
Q	2.80	3.20

- STYLE 1:
PIN 1. CATHODE
2. N/A
3. ANODE

ON Semiconductor and are registered trademarks of Semiconductor Components Industries, LLC (SCILLC). SCILLC owns the rights to a number of patents, trademarks, copyrights, trade secrets, and other intellectual property. A listing of SCILLC's product/patent coverage may be accessed at www.onsemi.com/site/pdf/Patent-Marking.pdf. SCILLC reserves the right to make changes without further notice to any products herein. SCILLC makes no warranty, representation or guarantee regarding the suitability of its products for any particular purpose, nor does SCILLC assume any liability arising out of the application or use of any product or circuit, and specifically disclaims any and all liability, including without limitation special, consequential or incidental damages. "Typical" parameters which may be provided in SCILLC data sheets and/or specifications can and do vary in different applications and actual performance may vary over time. All operating parameters, including "Typicals" must be validated for each customer application by customer's technical experts. SCILLC does not convey any license under its patent rights nor the rights of others. SCILLC products are not designed, intended, or authorized for use as components in systems intended for surgical implant into the body, or other applications intended to support or sustain life, or for any other application in which the failure of the SCILLC product could create a situation where personal injury or death may occur. Should Buyer purchase or use SCILLC products for any such unintended or unauthorized application, Buyer shall indemnify and hold SCILLC and its officers, employees, subsidiaries, affiliates, and distributors harmless against all claims, costs, damages, and expenses, and reasonable attorney fees arising out of, directly or indirectly, any claim of personal injury or death associated with such unintended or unauthorized use, even if such claim alleges that SCILLC was negligent regarding the design or manufacture of the part. SCILLC is an Equal Opportunity/Affirmative Action Employer. This literature is subject to all applicable copyright laws and is not for resale in any manner.

PUBLICATION ORDERING INFORMATION

LITERATURE FULFILLMENT:
Literature Distribution Center for ON Semiconductor
P.O. Box 5163, Denver, Colorado 80217 USA
Phone: 303-675-2175 or 800-344-3860 Toll Free USA/Canada
Fax: 303-675-2176 or 800-344-3867 Toll Free USA/Canada
Email: orderlit@onsemi.com

N. American Technical Support: 800-282-9855 Toll Free
USA/Canada
Europe, Middle East and Africa Technical Support:
Phone: 421 33 790 2910
Japan Customer Focus Center
Phone: 81-3-5817-1050

ON Semiconductor Website: www.onsemi.com
Order Literature: <http://www.onsemi.com/orderlit>
For additional information, please contact your local Sales Representative