

**A Fully Capable 500kW DC Link Solution
for Solar, Wind, and Network Power**

Power Ring Film Capacitor™ 3000 μF, 1100 Vdc

The 777A308911-103 Power Ring is a UL-recognized 1100 Vdc, 3000 μF DC Link Capacitor with an ESR of 150 micro-Ohms at 20 kHz and an ESL of 10 nH. An available adaptor is required for connection to the popular “half bridge” designs. (Note: 600, 1200 & 1500V versions also available.)

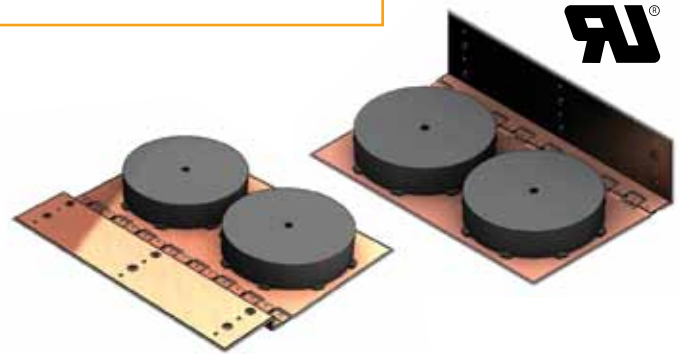

Electrical Specifications

SBE Part #: 777A308911-103

Capacitance/Tolerance: 3000 μF ±10%

DC Voltage Rating: 1100 Vdc

Dielectric/Construction: Metallized polypropylene.
Single section design.
2 - windings

Dielectric Withstand Voltage: Units 100% tested at DC potential of 1275 Volts for two minutes at 25°C

UL Recognition: UL 810

UL File #: E364956

ESL: ~10 nH at the typical “half bridge” type package connection

Thermal Resistance: 0.34°C/W (case side cooling only)
0.17°C/W (case and bus side cooling only)

Operating Temperature: -40°C to +85°C at full DC voltage rating

Voltage, Temperature De-rating: Contact SBE for applications above 85°C

System Fault Current Rating: 20,000 Amps maximum

Typical ESR vs. Frequency:

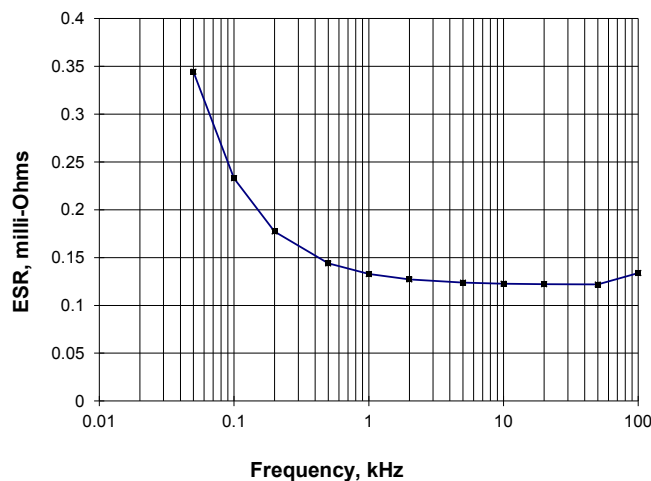

RMS Current Rating:

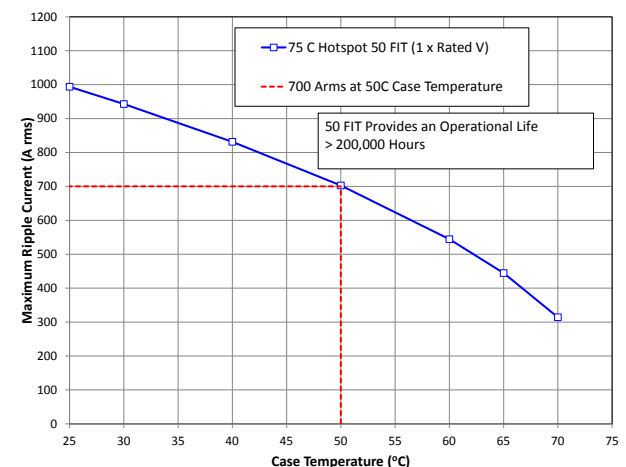

Mechanical Specifications

Dimensions:	See layout drawing for details	Marking: SBE Inc.	SBE company identification
Terminals:	Tin plated copper, 0.032" thick	777A103	SBE "short form" part number
Bus Structure:	Tin plated copper, 0.080" thick each plate.	3000 μ F \pm 10%	Capacitance value and tolerance
Adaptor:	Tin plated copper, 0.125" thick	1100 Vdc	DC voltage rating
Insulator:	Nomex or Mylar - UL 94-V0	yyww-lot#-unit	Serial number (date code, lot number, unit number)
Encapsulation:	Capacitors potted with RTV case - UL 94-V0		UL Recognition logo

Layout Details:

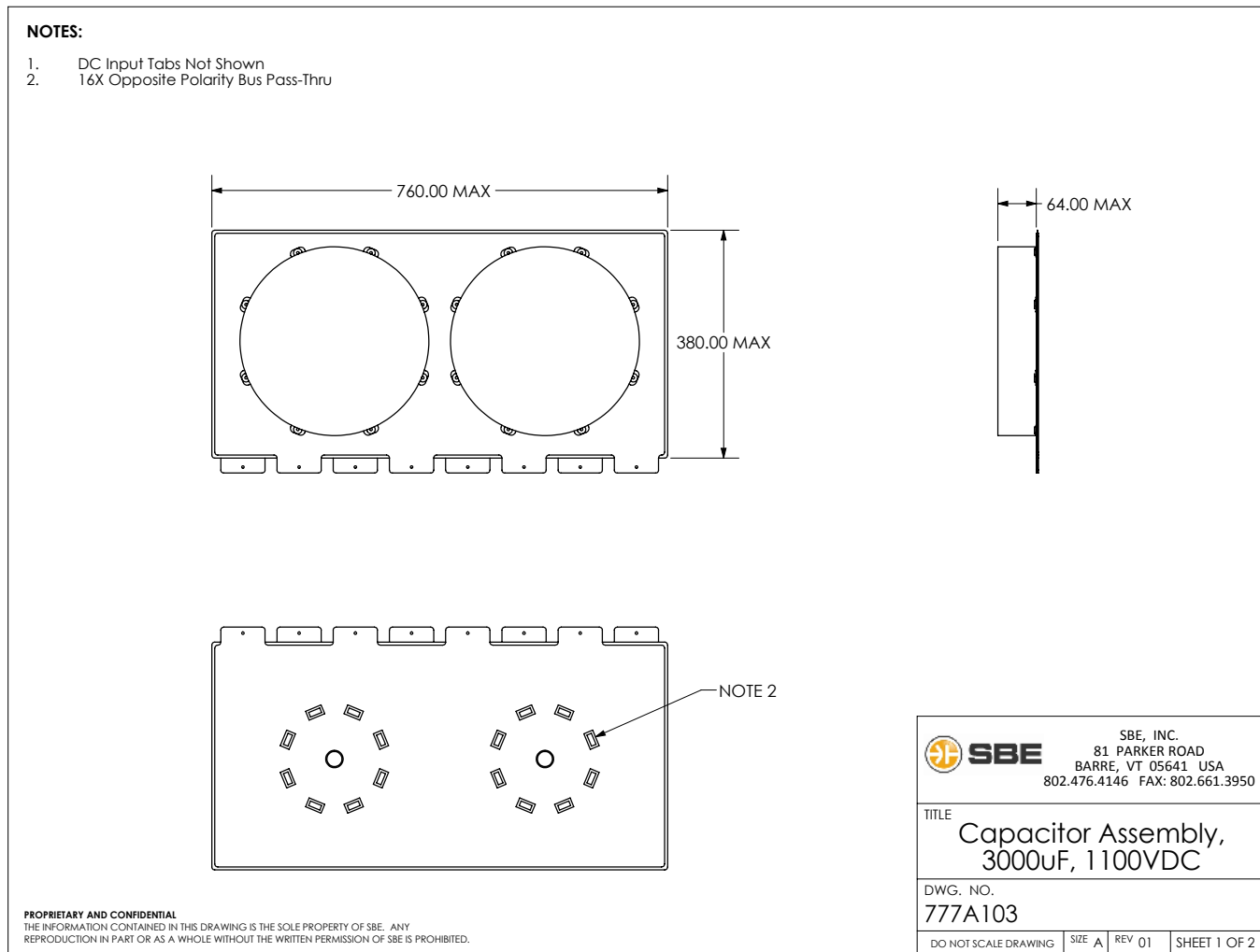

Contact SBE Inc. to discuss your specific requirements.

SBE reserves the right to amend design data

Double the Life or Power of your Inverter!

- Immediately reduce capacitor costs per kW rating or life requirement – or BOTH!
- Increase life and efficiency of inverter
- Increase reliability and reduce maintenance costs

In today's most advanced solar energy systems, Power Ring Film Capacitors™ are the DC link capacitors used in inverters and other power conversion systems. The Power Ring Film Capacitor™ greatly reduces both the total system cost per kW and component complexity requirements, while increasing long-term reliability required in today's demanding environments of the power grid. Often, we can achieve a 30 – 40% cost reduction or a doubling of power and/or lifetime at the same cost level.

SBE Power Ring Film Capacitors™ for solar applications have typical bus voltages ranging from 500 to 1500 Vdc and inverter stage ripple currents ranging from 100 to 1500 Arms at 2.5 – 7.5 kHz frequencies (Visit www.sbelectronics.com/products/specifications/ for details on the individual capacitor elements).

The SBE engineering team can help you with an optimized bank design which can drop in to your existing space or allow you to create a leading edge new design. Depending on ripple current, lifetimes range from 100,000 to over 500,000 hours at typical 45 – 60°C ambient conditions for this market.

SBE can usually provide a “drop in” bank solution to any existing film capacitor configuration to facilitate field testing and system evaluation. It also allows for convenient implementation of second sourcing since the “DC Link bank” is not changed dimensionally – but cost and performance are improved.

SBE's approach is to maximize the Power Ring capability of ripple current per micro-Farad to obtain the best system power density performance available in the industry for your component dollar and your cubic volume of space. In doing so, the DC Link bank is reduced and more tightly coupled to the IGBT.

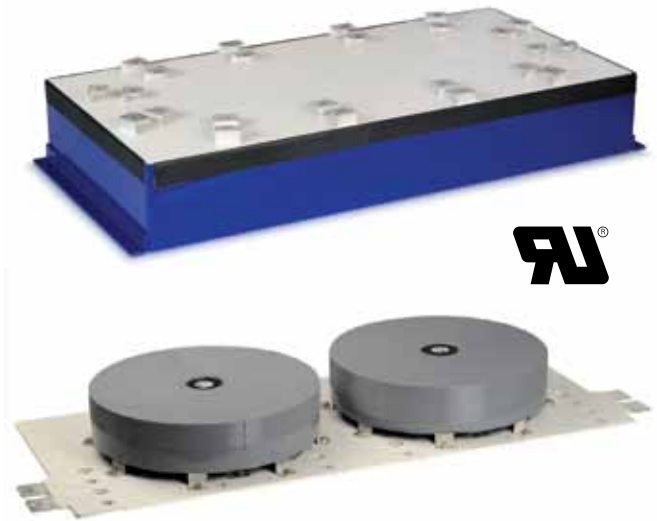

SBE has designed multiple options for the DC Link solution in 500kW rated modules (smaller versions for 200 – 400kW are available). The solutions are modular. For a leading edge power dense 1MW+ system, simply combine one or more of these units “end to end”. A one piece version is also available for any desired system size.

There are 3 styles of DC Link for Solar, Wind, and Network Power:

- 700A163 is the most space efficient horizontal configuration. In order to complete assembly, this unit ships with capacitors and bus separately. Because of connections interference, the IGBTs must be connected to the bus first and the capacitors mounted after.
- 777A103 is a highly space efficient horizontal design that allows for greater IGBT mounting flexibility which can be mounted at the customer site to a fully assembled – integrated DC Link shipped as one piece. These designs also allow for a thicker copper connections system at the IGBT (and typically DC input) for best cost optimization.
- 777A104 is a highly space efficient vertical design that has the minimal surface area by stacking the 2 x 1500µF capacitors on top of each other with a thick copper bus for high current density. The IGBT connections are available for connection at the customer site to a fully assembled integrated DC Link.

For some customers, the final bank size that meets all requirements may be too small for all system/grid event mitigation. In such cases we have created the “bank hardener” which combines the “Power of the Ring™ with the energy storage efficiency of electrolytics”. This technique allows for achievement of the desired goals simply by adding storage bank micro-Farads to handle all system requirements.

SBE’s Bank Hardener™ allows users of large micro-Farad banks of aluminum electrolytic, film, or super capacitors to “buffer” the bank from the DC link high ripple current need of the IGBT yet still meeting the storage needs of the larger micro-Farad banks. These storage needs are typically grid ride through, event control, and driver related needs. This industry-first configuration can be used to achieve one of two highly advantageous outcomes:

- 1. Reduced Aluminum Electrolytic bank size, cost, and failure points** - The overall bank of capacitors can contain fewer capacitors, at much lower cost, yet extend the life of the bank by up to 2 to 3 times.
- 2. Increase Power** - The design can facilitate a substantial system power increase utilizing the same volume allocated to the original bank, which is perfect for the migration of existing tightly packed power cabinets to 0.5MW or 1MW+ system levels.

Lastly, there is no need for the full bank to reside in the same cabinet any more since the Power Ring buffer will accommodate all of the tightly coupled DC Link requirements allowing the storage bank portion to be positioned anywhere convenient in the system environment.

SBE is engaging designs in the industry globally. We are ready to introduce your team to the great benefits that others in the industry are implementing in their next generation systems. Feel free to download our Solar and Wind presentation at www.sbelectronics.com/applications/solar/ and contact us to set up a call or to discuss your system requirements.



Bank Hardener

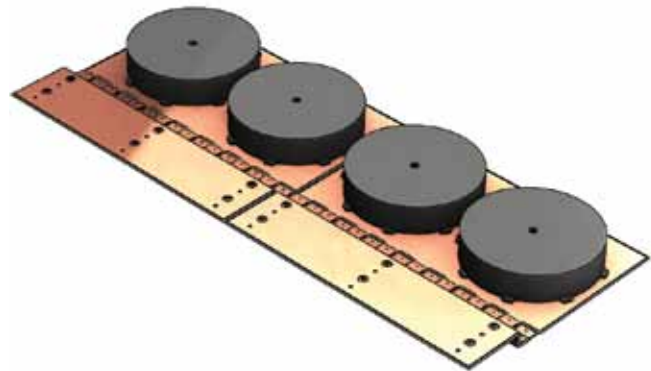

1MW Implementation of 777A

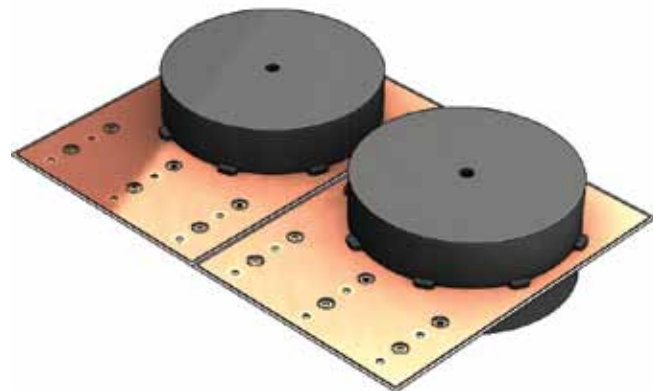

1MW Implementation of 777A

#SBE-Solar4-page-777A103-02/14