

# AN12940AA

## Audio signal processing IC for notebook PC

### ■ Overview

The AN12940AA is an amplifier IC for stereo speakers which can output 1 W by 8  $\Omega$  or 2 W by 4  $\Omega$ .

The AGC circuit is built-in to prevent the resonance or the vibration by the speaker's energy and the clipping distortion what is called "broken up sound." of the speakers.

Also the AN12940AA is built-in power saving on/off function automatically detecting input signal to save the power.

### ■ Features

- Speaker amplifier is
  - 1 W  $\times$  2-ch: 8  $\Omega$ ,  $V_{CC} = 5$  V or
  - 2 W  $\times$  2-ch: 4  $\Omega$ ,  $V_{CC} = 5$  V
- Built-in AGC circuit
  - Prevention of the resonance or the vibration by the speaker's energy and the clipping distortion of the speaker by AGC at excessive input signal (with AGC on/off switch).
- Built-in automatic power saving function
  - It detects input signals and switches on/off (with the on/off switch for the automatic power saving).
- Any shock noise free at the automatic power saving operation.

### ■ Applications

- Notebook PC, LCD monitor with speaker

### ■ Package

- HSOP056-P-0300A

### ■ Block Diagram

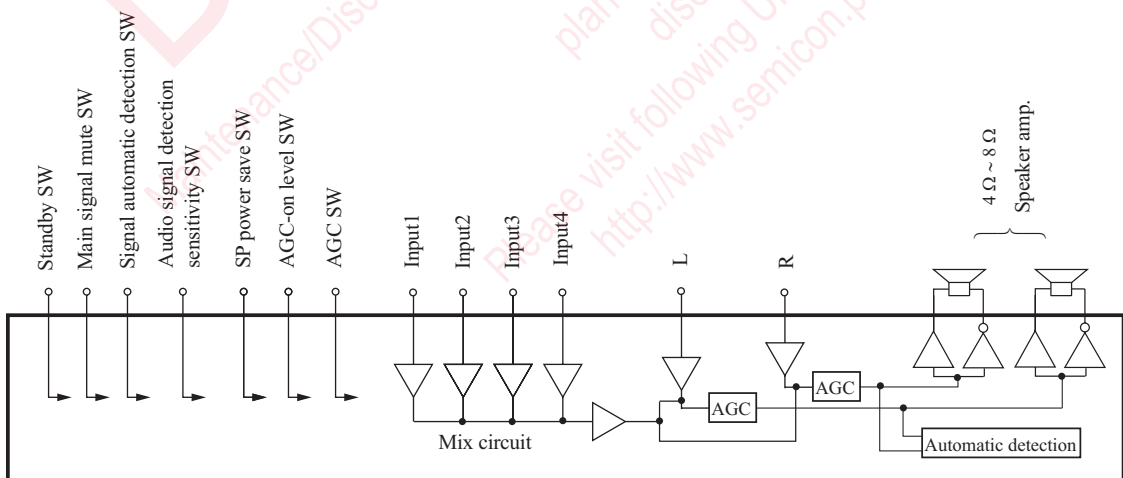

■ Application Circuit Example

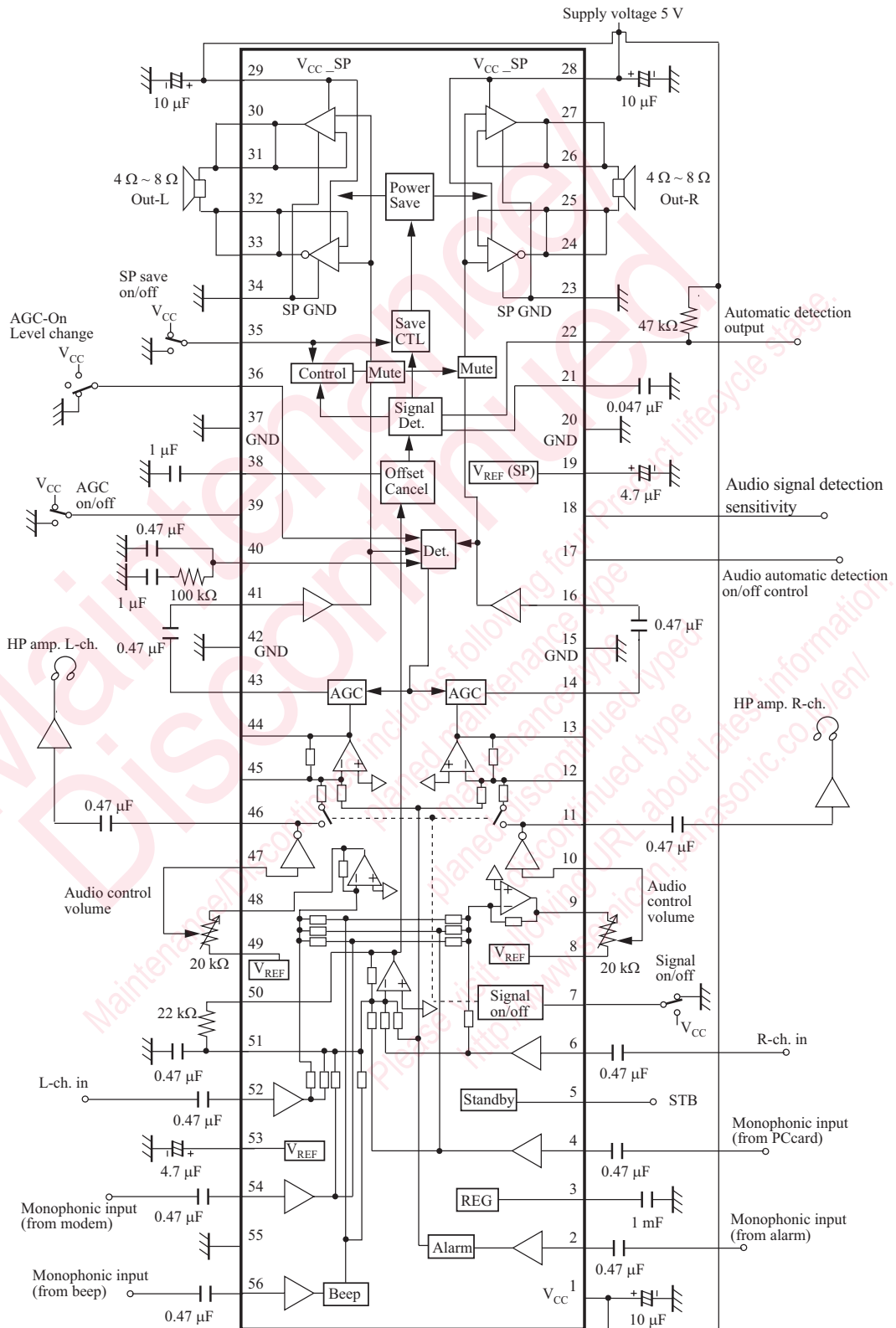

## ■ Pin Description

Pin No.	Description	Pin No.	Description
1	V <sub>CC</sub>	30	SP amplifier L-channel negative phase output (-)
2	Input for alarm		
3	REG ripple filter pin	31	SP amplifier L-channel negative phase output (-)
4	Input for PCcard		
5	Standby on/off control	32	SP amplifier L-channel positive phase output (+)
6	R-channel input		
7	Main signal mute on/off control	33	SP amplifier L-channel positive phase output (+)
8	V <sub>REF</sub> R-channel for volume		
9	Audio mix amplifier R-channel output	34	GND_SP L-channel
10	Volume control signal R-channel input	35	SP power save control
11	R-channel output for HP amplifier	36	AGC-on level control
12	Negative feedback pin for alarm mix amplifier R-channel	37	GND
		38	Offset cancel pin for signal automatic detection
13	Alarm mix amplifier R-channel output	39	AGC on/off control
14	AGC R-channel output		
15	GND	40	AGC demodulation pin
16	SP amplifier R-channel input	41	SP amplifier L-channel input
17	Signal automatic detection on/off control	42	GND
18	Signal automatic detection sense control	43	AGC R-channel output
19	V <sub>REF_SP</sub>	44	Alarm mix amplifier L-channel output
20	GND	45	Negative feedback pin for alarm mix amplifier L-channel
21	Demodulation pin for signal automatic detection	47	Volume control signal L-channel input
22	Signal automatic detection output	48	Audio mix amplifier L-channel output
23	GND_SP R-channel	49	V <sub>REF</sub> L-channel for volume
24	SP amplifier R-channel positive phase output (+)		
25	SP amplifier R-channel positive phase output (+)	50	Signal automatic detection mix amplifier output
		51	Negative feedback pin for signal automatic detection mix amplifier
26	SP amplifier R-channel negative phase output (-)		
27	SP amplifier R-channel negative phase output (-)	53	V <sub>REF</sub>
		54	Input for modem
28	V <sub>CC_SP</sub> R-channel	55	GND
29	V <sub>CC_SP</sub> L-channel	56	Input for beep

Note) SP : Speaker  
 HP : Headphone  
 REG: Regulator

### ■ Absolute Maximum Ratings

Parameter	Symbol	Rating	Unit
Supply voltage *1	$V_{CC}$	5.75	V
	$V_{CC\_SP}$	5.75	
Supply current	$I_{CC}$	—	A
Power dissipation *2	$P_D$	2620	mW
Operating ambient temperature *3	$T_{opr}$	-20 to +75	°C
Storage temperature *3	$T_{stg}$	-55 to +150	°C

Note) \*1: The values under the condition the above absolute maximum ratings and the power dissipation.

\*2:  $T_a = 75^\circ\text{C}$ , the value under the condition which this device is mounted on a four-layer printed wiring board and in addition its radiation part is soldered. (Reference to ■ Technical Data, • Power dissipation of package HSOP056-P-0300A)

\*3: Except for the storage temperature and operating ambient temperature, all ratings are for  $T_a = 25^\circ\text{C}$ .

### ■ Recommended Operating Range

Parameter	Symbol	Range	Unit
Supply voltage	$V_{CC}$	4.5 to 5.5	V
Supply voltage*1	$V_{CC\_SP}$	4.5 to 5.5	

Note) \*1: The values under the condition the above absolute maximum ratings and the power dissipation.

### ■ Electrical Characteristics at $V_{CC} = 5\text{ V}$ , $V_{CC\_SP} = 5\text{ V}$ , ( $T_a = 25^\circ\text{C} \pm 2^\circ\text{C}$ unless otherwise specified.)

Parameter	Symbol	Conditions	Min	Typ	Max	Unit
Circuit current						
Circuit current 1A at non-signal ( $V_{CC}$ )	$I_{VCCA}$	$V_{CC} = 5\text{ V}$ , at non-signal, Automatic distinction: on	2.0	4.0	6.0	mA
Circuit current 2A at non-signal ( $V_{CC\_SP}$ )	$I_{VCCSA}$	$V_{CC} = 5\text{ V}$ , at non-signal, Automatic distinction: on	—	200	500	$\mu\text{A}$
Circuit current 1B at non-signal ( $V_{CC}$ )	$I_{VCCB}$	$V_{CC} = 5\text{ V}$ , at non-signal, Power save: off at non-automatic distinction	2.2	4.5	6.8	mA
Circuit current 2B at non-signal ( $V_{CC\_SP}$ )	$I_{VCCSB}$	$V_{CC} = 5\text{ V}$ , at non-signal, Power save: off at non-automatic distinction	—	8.1	16.2	mA
Circuit current 1C at non-signal ( $V_{CC}$ )	$I_{VCCC}$	$V_{CC} = 5\text{ V}$ , at non-signal, Power save: on at non-automatic distinction	1.5	3.5	5.5	mA
Circuit current 2C at non-signal ( $V_{CC\_SP}$ )	$I_{VCCSC}$	$V_{CC} = 5\text{ V}$ , at non-signal, Power save: on at non-automatic distinction	—	200	500	$\mu\text{A}$
Circuit current 1D at non-signal $V_{CC}$	$I_{VCCD}$	$V_{CC} = 5\text{ V}$ , at standby mode	—	20	50	$\mu\text{A}$
Circuit current 2D at non-signal ( $V_{CC\_SP}$ )	$I_{VCCSD}$	$V_{CC} = 5\text{ V}$ , at standby mode	—	10	50	$\mu\text{A}$

■ Electrical Characteristics at  $V_{CC} = 5\text{ V}$ ,  $V_{CC\_SP} = 5\text{ V}$ , ( $T_a = 25^\circ\text{C} \pm 2^\circ\text{C}$  unless otherwise specified.)  
(continued)

Parameter	Symbol	Conditions	Min	Typ	Max	Unit
Speaker amplifier (Pin 52, pin 6 → pin 24 to pin 27, pin 33 to pin 30)						
L-channel audio output level	$V_{OSPL}$	$V_{IN} = -16\text{ dBV}$ , 1 kHz, $R_L = 8\ \Omega$	2.0	4.0	6.0	dBV
R-channel audio output level	$V_{OSPR}$	$V_{IN} = -16\text{ dBV}$ , 1 kHz, $R_L = 8\ \Omega$	2.0	4.0	6.0	dBV
L-channel audio output distortion	$TH_{SPL}$	$V_{IN} = -16\text{ dBV}$ , 1 kHz, $R_L = 8\ \Omega$ to THD fifth	—	0.04	0.5	%
R-channel audio output distortion	$TH_{SPR}$	$V_{IN} = -16\text{ dBV}$ , 1 kHz, $R_L = 8\ \Omega$ to THD fifth	—	0.04	0.5	%
L-channel audio output noise	$V_{NSPL}$	At non-signal, $R_L = 8\ \Omega$ A curve filter	—	-74	-68	dBV
R-channel audio output noise	$V_{NSPR}$	At non-signal, $R_L = 8\ \Omega$ A curve filter	—	-74	-68	dBV
L-channel maximum output power	$V_{M8SPL}$	$V_{IN} = 1\text{ kHz}$ , at THD = 10%, $R_L = 8\ \Omega$ , to THD fifth, at AGC = off	0.7	1.0	—	W
R-channel maximum output power	$V_{M8SPR}$	$V_{IN} = 1\text{ kHz}$ , at THD = 10%, $R_L = 8\ \Omega$ , to THD fifth, at AGC = off	0.7	1.0	—	W
L-channel maximum output power	$V_{M4SPL}$	$V_{IN} = 1\text{ kHz}$ , at THD = 10%, $R_L = 4\ \Omega$ , to THD fifth, at AGC = off	—	2.0	—	W
R-channel maximum output power	$V_{M4SPR}$	$V_{IN} = 1\text{ kHz}$ , at THD = 10%, $R_L = 4\ \Omega$ , to THD fifth, at AGC = off	—	2.0	—	W
Cross talk R-channel → L-channel	$V_{CTSPL}$	$V_{IN} = -16\text{ dBV}$ , 1 kHz, $R_L = 8\ \Omega$ A curve filter	70	76	—	dB
Cross talk L-channel → R-channel	$V_{CTSPR}$	$V_{IN} = -16\text{ dBV}$ , 1 kHz, $R_L = 8\ \Omega$ A curve filter	70	76	—	dB
AGC output level	$V_{AGSPL}$ $V_{AGSPR}$	$V_{IN} = -6\text{ dBV}$ , 1 kHz, $R_L = 8\ \Omega$ A curve filter	5.5	7.0	8.5	dBV
Mix amplifier characteristic 1 (Pin 4, pin 54, pin 56 → pin 46, pin 11)						
L-channel, R-channel output level at beep signal mix	$V_{BESPL}$ $V_{BESPR}$	$V_{IN} = -10\text{ dBV}$ , 1 kHz, pin 56 input	-14	-13	-12	dBV
L-channel, R-channel output level at modem signal mix	$V_{MDSPL}$ $V_{MDSPR}$	$V_{IN} = -10\text{ dBV}$ , 1 kHz, pin 54 input	-14	-13	-12	dBV
L-channel, R-channel output level at PCCard signal mix	$V_{PCSPL}$ $V_{PCSPR}$	$V_{IN} = -10\text{ dBV}$ , 1 kHz, pin 4 input	-14	-13	-12	dBV
Each entry pin max input level	—	$V_{IN} = 1\text{ kHz}$ , $V_{IN}$ at THD = 1%	1.2	—	—	$V_{rms}$
Maximum amplifier output for the HP amplifier	$V_{HPMAL}$ $V_{HPMAR}$	$V_{IN} = 1\text{ kHz}$ , $V_{IN}$ at THD = 1%	0.85	—	—	$V_{rms}$
Mix amplifier characteristic 2 (Pin 56, pin 54, pin 52, pin 2, pin 4, pin 6 → pin 44, pin 13)						
L-channel, R-channel mix amplifier cross talk in case of signal off	$V_{OFSP}$ $V_{OFSPR}$	$V_{IN} = -10\text{ dBV}$ , 1 kHz pin 4,6,52,54,56: input	—	-74	-68	dBV
L-channel, R-channel mix amplifier cross talk in case of signal off	$V_{ARSPL}$ $V_{ARSPR}$	$V_{IN} = -10\text{ dBV}$ , 1 kHz pin 2: input	-12	-10	-8	dBV

■ Electrical Characteristics at  $V_{CC} = 5\text{ V}$ ,  $V_{CC\_SP} = 5\text{ V}$ , ( $T_a = 25^\circ\text{C} \pm 2^\circ\text{C}$  unless otherwise specified.)  
(continued)

Parameter	Symbol	Conditions	Min	Typ	Max	Unit
Signal detection system characteristic (Pin 52, pin 6, pin 54, pin 56, pin 2, pin 4 → pin 50)						
Pre-amplifier output at L-channel input	$V_{SDTL}$	$V_{IN} = -45\text{ dBV}$ , 1 kHz	-12	-10	-8	dBV
Pre-amplifier output at R-channel input	$V_{SDTR}$	$V_{IN} = -45\text{ dBV}$ , 1 kHz	-12	-10	-8	dBV
Pre-amplifier output at beep signal input	$V_{SDTBE}$	$V_{IN} = -45\text{ dBV}$ , 1 kHz	-12	-10	-8	dBV
Pre-amplifier output at modem signal input	$V_{SDTMD}$	$V_{IN} = -45\text{ dBV}$ , 1 kHz	-12	-10	-8	dBV
Pre-amplifier output at PCCard signal input	$V_{SDTPC}$	$V_{IN} = -45\text{ dBV}$ , 1 kHz	-12	-10	-8	dBV
Pre-amplifier output at alarm signal input	$V_{SDTAR}$	$V_{IN} = -45\text{ dBV}$ , 1 kHz	-12	-10	-8	dBV
Detection level 1 at high sensitivity	$V_{SDTTH}$	$V_{IN} = 1\text{ kHz}$	-72	-67	-62	dBV
Detection level 2 at low sensitivity	$V_{SDTTL}$	$V_{IN} = 1\text{ kHz}$	-66	-61	-56	dBV
Distinction output high level	$V_{SDTHI}$	$V_{IN} = 1\text{ kHz}$	4.0	5.0	—	V
Distinction output low level	$V_{SDTLO}$	$V_{IN} = 1\text{ kHz}$	—	0.1	1.0	V
Voltage holding mode						
Entry signal on/off Voltage range holding on	$V_{7H}$	—	2.0	—	5.0	V
Entry signal on/off Voltage range holding off	$V_{7L}$	—	0.0	—	0.8	V
AGC on/off Voltage range holding on	$V_{39H}$	—	2.0	—	5.0	V
AGC on/off Voltage range holding off	$V_{39L}$	—	0.0	—	0.8	V
Signal automatic detection function Voltage range holding on	$V_{17H}$	—	2.0	—	5.0	V
Signal automatic detection function Voltage range holding off	$V_{17L}$	—	0.0	—	0.8	V
Standby on/off Voltage range holding off	$V_{5H}$	—	2.0	—	5.0	V
Standby on/off Voltage range holding on	$V_{5L}$	—	0.0	—	0.8	V
SP amplifier power save on/off Voltage range holding off	$V_{35H}$	—	2.0	—	5.0	V
SP amplifier power save on/off Voltage range holding on	$V_{35L}$	—	0.0	—	0.8	V
It changes automatic detection sensitivity Voltage range holding high	$V_{18H}$	—	2.0	—	5.0	V
It changes automatic detection sensitivity Voltage range holding low	$V_{18L}$	—	0.0	—	0.8	V

■ Electrical Characteristics at  $V_{CC} = 5\text{ V}$ ,  $V_{CC\_SP} = 5\text{ V}$ , ( $T_a = 25^\circ\text{C} \pm 2^\circ\text{C}$  unless otherwise specified.)  
(continued)

Parameter	Symbol	Conditions	Min	Typ	Max	Unit
Voltage holding mode (continued)						
It changes AGC-on level Voltage range holding standard voltage	$V_{36L}$	—	0.0	—	0.5	V
It changes AGC-on level Voltage range holding Ref. -1 dB	$V_{36C}$	—	—	Open	—	V
It changes AGC-on level Voltage range holding Ref. -3 dB	$V_{36H}$	—	2.5	—	5.0	V

■ Control terminal , The mode table

Pin No.	Pin name	voltage of Pin		Remarks
		Low	High	
7	Entry signal on/off	Signal off	Signal on	In case of signal off, the alarm signal is always on.
39	AGC on/off	AGC off	AGC on	—
17	Signal automatic detection function	Automatic distinction off	Automatic distinction on	—
5	Standby on/off	STB on	STB off	—
35	SP power save on/off	Save on (SP off)	Save off (SP on)	The power saving operation by pin 35 has priority over any automatic detection
18	The signal automatic detection changes sensitivity	Low sensitivity mode	High sensitivity mode	The sensitivity difference is about 6 dB.

Pin No.	Pin name	Voltage of Pin		
		Low	Open	High
36	At the time of AGC: on, It changes on level.	Reference level on	Reference level -1 dB on	Reference level -3 dB on

Note) \*: The holding range of control voltage is shown in page 6 to page 7 of ■ Electrical Characteristics.

■ Terminal Equivalent Circuits

Pin No.	Equivalent Circuits	Description	Corrugation and Voltage
28 29	—	$V_{CC\_SP}$ : It is the specifically designed power pin of the speaker amplifier. • Pin 28 is for R-channel • Pin 29 is for L-channel Because the big electric current flows, it is desirable to separate from the $V_{CC}$ line to the other power pin on the board pattern.	DC 5 V



■ Terminal Equivalent Circuits (continued)

Pin No.	Equivalent Circuits	Description	Corrugation and Voltage
25 26 31 32 24 27 30 31		<p>Speaker Output:</p> <p>It is output pins of the speaker amplifier. It becomes BTL output.</p> <p>The L-channel positive phase output pin: Pin 32, pin 33</p> <p>The L-channel negative phase output pin: Pin 30, pin 31</p> <p>The R-channel positive phase output pin: Pin 24, pin 25</p> <p>The R-channel negative phase output pin: Pin 26, pin 27</p> <p>To reduce voltage loss by the wire resistance in maximum output, it makes output 2 pins. Also, when the speaker amplifier saves power, too, DC voltage is maintained.</p> <p>The output impedance: Equal to or less than 10 Ω</p>	<p>DC 2.2 V AC 4 dBV</p> <p>Pin 32, pin 33 Pin 24, pin 25 positive</p> <p>Pin 30, pin 31 Pin 26, pin 27</p>
23 34		<p>GND:</p> <p>It is GND pin for the speaker amplifier.</p> <p>Pin 23 is for R-channel Pin 34 is for L-channel</p> <p>Because the big electric current flows, it is desirable to separate from the GND line to the other GND pin on the board pattern. Also, it isn't connected with the substrate potential in the IC.</p>	<p>DC 0 V</p>
22		<p>Audio signal automatic detection distinction output:</p> <p>It outputs the distinction result of the audio signal automatic detection circuit.</p> <p>The output form is the open collector output from of the NPN transistor.</p> <p>Therefore, the pull rises and uses for the power by the external resistance ( equal to or more than 10 kΩ ).</p> <p>Signal's there being: Output high Signal nothing : Output low</p> <p>Open collector output</p> <p>The electric current ability: Equal to or more than 100 μA</p>	<p>Signal nothing DC 0 V Signals there being DC 5 V</p>

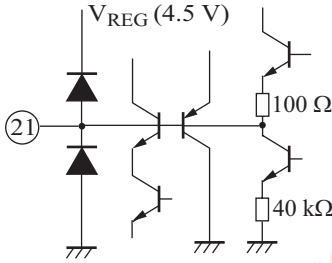
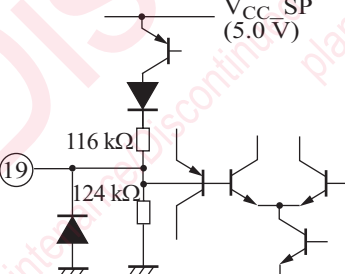
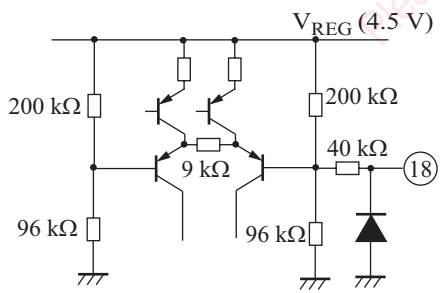

■ Terminal Equivalent Circuits (continued)

Pin No.	Equivalent Circuits	Description	Corrugation and Voltage
21		<p>Audio automatic detecting detection pin:</p> <p>It connects a condenser for the peak detection. It is the circuit which detects a peak after rectifying the audio signal of the audio signal automatic detection circuit in both waves. By changing a capacity value, the time which the power saving depends on in case of the switchover which is without signal with signal's there being can be changed.</p> <p>Signal less time: Constant current source</p> <p>Signal's there being: Emitter follower</p> <p>The output impedance: About 200 Ω</p>	<p>Signal nothing DC 0 V</p> <p>Signals there being DC 2 V</p>
15 20 37 42 55	<p style="text-align: center;">—</p>	<p>GND:</p> <p>It is the GND pin of the signal system. It is connected with the substrate potential of the IC. Pin 15, pin 42 connect with the lead frame of the IC.</p>	<p>DC 0 V</p>
19		<p><math>V_{REF}(SP)</math>:</p> <p>It is the standard voltage pin to fix the DC bias of the speaker output. It connects a condenser to remove a ripple.</p> <p>The output impedance: About 60 kΩ</p>	<p>DC 2.2 V</p>
18		<p>Change the audio signal detection sensitivity:</p> <p>It is the pin to change the detections sensitivity of the audio signal automatic detection circuit. 2 choices of the high sensitivity mode and the low sensitivity mode are possible and it is possible to about 6 dB change sensitivity.</p> <p>Low: Low sensitivity mode High: High sensitivity mode</p> <p>The output impedance: About 105 kΩ</p>	<p>voltage in case of opening DC 1.45 V</p>

■ Terminal Equivalent Circuits (continued)

Pin No.	Equivalent Circuits	Description	Corrugation and Voltage
17		<p>Signal automatic detection function on/off control pin:</p> <p>We change an audio signal automatic detection function in on/off. In case of automatic detection off, it controls power saving by speaker with the manual with the power saving on/off pin.</p> <p>High: Function on Low: Function off</p> <p>The entry impedance: The high impedance</p>	<p>DC —</p>
16 41		<p>Speaker amplifier entry:</p> <p>It is the voice input pins of the speaker amplifier. To make offset voltage in power saving on/off changing by the Speaker amplifier amplifier little, it combines capacity.</p> <p>( It makes pop noise small ).</p> <p>Pin 16: R-channel SP amplifier entry Pin 41: L-channel SP amplifier entry</p> <p>The entry impedance: About 50 kΩ</p>	<p>DC 2.25 V AC -16 dBV</p>
14 43		<p>AGC amplifier output:</p> <p>It is the output pin of the AGC circuit to hold an output clip in excessive output of the speaker output.</p> <p>Pin 14: The AGC R-channel output Pin 43: The AGC L-channel output</p> <p>The output impedance: Equal to or less than about 10 Ω</p>	<p>DC 2.25 V AC -16 dBV</p>
13 44		<p>Alarm mix amplifier output pins:</p> <p>It is output pins of the mix amplifier to mix an alarm signal and an audio signal.</p> <p>Pin 13: R-channel output Pin 44: L-channel output</p> <p>The output impedance: Equal to or less than about 10 Ω</p>	<p>DC 2.25 V AC -16 dBV</p>

■ Terminal Equivalent Circuits (continued)

Pin No.	Equivalent Circuits	Description	Corrugation and Voltage
<p>12 45</p>		<p>Alarm mix amplifier negative feedback pins: It is the negative feedback of the mix amplifier to mix an alarm signal and an audio signal. It is possible to adjust in the direction which lowers the gain of the mix amplifier in putting resistance among above mentioned mix amplifier output pins. Pin 12: R-channel negative feedback pin Pin 45: L-channel negative feedback pin Between pin 12 and pin 13 : about 9 kΩ Between pin 44 and pin 45 : about 9 kΩ The entry impedance: Equal to or less than about 10 Ω</p>	<p>DC 2.25 V</p>
<p>9 48</p>		<p>Audio signal mix amplifier output pin: It is the output of the mix amplifier to mix a signal from the modem, the beep, the PCard to an audio signal. Pin 9: The R-channel output Pin 48: The L-channel output The output impedance: Equal to or less than about 10 Ω</p>	<p>DC 2.25 V AC -19 dBV</p>
<p>10 47</p>		<p>Revision amplifier entry: It is the amplifier entry to adjust an output level to the HP amplifier. It becomes the entry of the EVR adjustment signal. The entry impedance: The High impedance</p>	<p>DC — AC -19 dBV</p>

■ Terminal Equivalent Circuits (continued)

Pin No.	Equivalent Circuits	Description	Corrugation and Voltage
7		<p>Audio signal on/off changing control pin:</p> <p>It is the control pin which changes whether to communicate an audio signal to the amplifier to mix an alarm signal and an audio signal. At the time of off, only an alarm audio is output from the mix amplifier.</p> <p>High: Signal on Low: Signal off</p> <p>The entry impedance: About 105 kΩ</p>	<p>Open voltage DC 1.45 V</p>
6 52		<p>Audio signal input:</p> <p>It enters a main audio signal.</p> <p>Pin 6: R-channel entry Pin 52: L-channel entry</p> <p>The entry impedance: About 45 kΩ</p>	<p>DC 2.25V AC -16 dBV</p>
4		<p>PCcard signal entry:</p> <p>It is the entry pin to enter a signal from the PCard. With the audio signal mix amplifier of the following paragraph, the same signal is entered both by L-channel and R-channel. Also, it has the function which is the same as the beep entry of pin 56, the modem entry by pin 54 completely.</p> <p>The entry impedance: About 45 kΩ</p>	<p>DC 2.25V AC -16 dBV</p>
3		<p>Ripple removal condenser pin for the regulator:</p> <p>To remove a power ripple with the regulator circuit to create the inner power (<math>V_{REG}</math>), it puts a condenser.</p> <p>The entry impedance: About 100 kΩ</p>	<p>DC 2.25 V</p>

■ Terminal Equivalent Circuits (continued)

Pin No.	Equivalent Circuits	Description	Corrugation and Voltage
2		<p>Alarm entry: It is the entry pin to enter an alarm signal. With the alarm mix amplifier, the same signal is entered both by L-channel and R-channel. The entry impedance: About 45 kΩ</p>	<p>DC 2.25 V AC -16 dBV</p>
1	—	<p>V<sub>CC</sub>: It is the power (V<sub>CC</sub>) pin to supply the regulator circuit to create the inner power V<sub>REG</sub> with the voltage. It is separating from V<sub>CC_SP</sub> of pin 28, pin 29 fully inside. It is desirable to separate as far as it finishes coming out about the P board pattern, too.</p>	<p>DC 5.0 V</p>
5		<p>Standby on/off changing SW: It changes whether or not it makes this IC an operation condition or whether or not it makes it a standby. Low: Standby High: The operation condition In that the power changes a connected condition to the standby, the circuit electric current can be almost made 0. The entry impedance: About 80 kΩ</p>	<p>Open voltage DC 0 V</p>
56		<p>Beep input: It is the entry pin to enter beep signal. The same signal is entered both by L-channel and R-channel with the audio signal mix amplifier of the following paragraph. Also, it has the function which is the same as the PCard signal entry by pin 4, the modem signal entry by pin 54 completely. The entry impedance: About 45 kΩ</p>	<p>DC 2.25 V AC -16 dBV</p>

### ■ Terminal Equivalent Circuits (continued)

Pin No.	Equivalent Circuits	Description	Corrugation and Voltage
53		<p><math>V_{REF}</math>:</p> <p>With the pin to fix the bias voltage (the operation point) of the system which the inner power (<math>V_{REG}</math>) works, it becomes <math>1/2V_{REG}</math> (V). To remove noise, it connects a condenser with the interval of between pin 53 and GND.</p> <p>The entry impedance: About 80 k<math>\Omega</math></p>	DC 2.25 V
54		<p>Modem input:</p> <p>It is the entry pin to enter a signal from the modem. With the audio signal mix amplifier of the following paragraph, the same signal is entered both by L-channel and R-channel. Also, it has the function which is the same as the PCard signal entry by pin 4, the beep signal entry by pin 56 completely.</p> <p>The entry impedance: About 45 k<math>\Omega</math></p>	DC 2.25 V AC -16 dBV
51		<p>The signal detection system pre-amplifier negative feedback pin:</p> <p>It is the negative feedback pin of the signal detection system pre-amplifier. It is possible to adjust in the direction with the output (pin 50) which lowers a gain by adding external resistance between.</p> <p>The entry impedance: About 0 <math>\Omega</math></p>	DC 2.25 V
50		<p>The signal detection system pre-amplifier output pin:</p> <p>It is the output pin of the signal detection system pre-amplifier. It is possible to adjust in the direction which lowers a gain by adding external resistance among the negative feedback pins (pin 51).</p> <p>The entry impedance: About 0 <math>\Omega</math></p>	DC 2.25 V AC -10 dBV

■ Terminal Equivalent Circuits (continued)

Pin No.	Equivalent Circuits	Description	Corrugation and Voltage
40		<p>AGC detection pin: It is the detection circuit to detect the signal level of the AGC circuit of the SP output for the clip prevention. It connects a condenser for the detection. The entry impedance: Unsettled</p>	<p>DC 0 to 1 V</p>
39		<p>AGC on/off control pin: It is the pin which controls the operating operation of the AGC circuit of the SP output for the clip prevention in on/off. At the time of off, the AGC circuit doesn't work. Low: AGC-off High: AGC-on The entry impedance: About 76 kΩ</p>	<p>DC —</p>
38		<p>Offset cancellation pin: It is the condenser connection pin of the offset cancellation circuit to remove the DC offset voltage of the signal which enters a distinction circuit in the audio signal automatic detection system. As the principle, it composes HPF by entry impedance "R" and connection condenser "C". The entry impedance: About 80 kΩ</p>	<p>DC 2.25 V</p>
36		<p>It changes AGC-on level: It is the pin which changes the on level of AGC. Low : The standard level Open : -1 dB of standards High : -3 dB of standards The entry impedance: About 120 kΩ</p>	<p>DC 1.5 V</p>



■ Terminal Equivalent Circuits (continued)

Pin No.	Equivalent Circuits	Description	Corrugation and Voltage
35		<p>SP amplifier power saving on/off control pin:</p> <p>It is the pin which controls power saving by the SP amplifier. At the time of on in addition to the control in case of automatic distinction function off, too, power saving on by pin 50 has priority over.</p> <p>The entry impedance: About 137 kΩ</p>	<p>DC 1.3 V</p>
8 49		<p>Standard bias source for EVR:</p> <p>It is possible to use as GND (the DC bias source) AC when connecting external EVR. It is possible to attenuate attenuate in the AC signal without cutting a signal system in "C".</p> <p>The output impedance: Equal to or less than about 10 Ω</p>	<p>DC 2.25 V</p>
11 46		<p>Output pins for the HP amplifier:</p> <p>It is output pins for the external HP amplifier. The signal which was adjusted in the volume in EVR can be output by the low impedance.</p> <p>The output impedance: Equal to or less than about 10 Ω</p>	<p>DC 2.25 V AC dBV</p>

■ Technical data

1. Power dissipation of package HSOP056-P-0300A

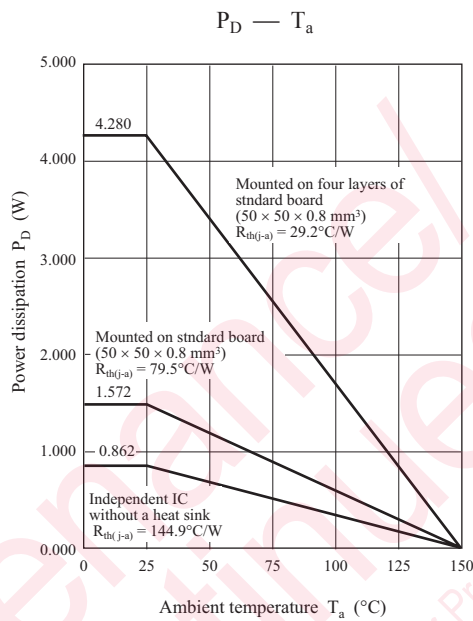

Note) \*: The above characteristic is a reference value in case of design and is not a guarantee value.

■ Technical data (continued)

1) SP amplifier

(1) L-in,R-in → L-out,R-out mode

SP I/O characteristics — 8Ω

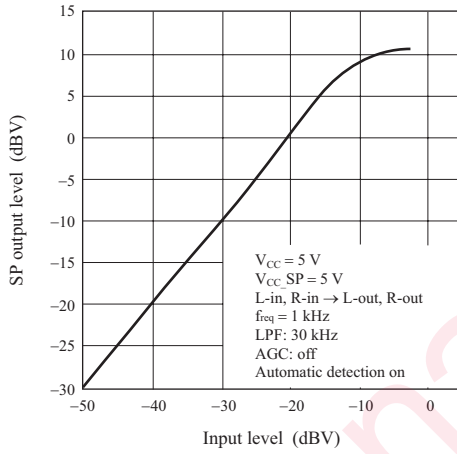

SP I/O characteristics — 8Ω

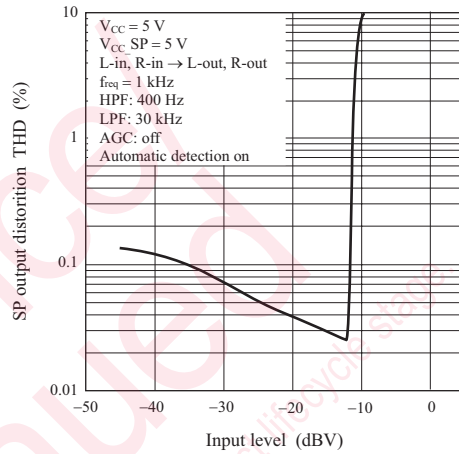

SP output frequency characteristics — 8Ω

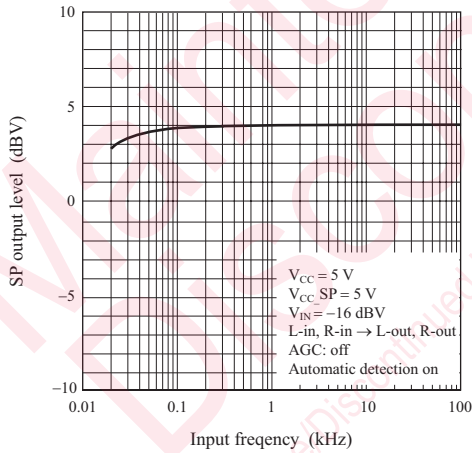

SP output frequency characteristics — 8Ω

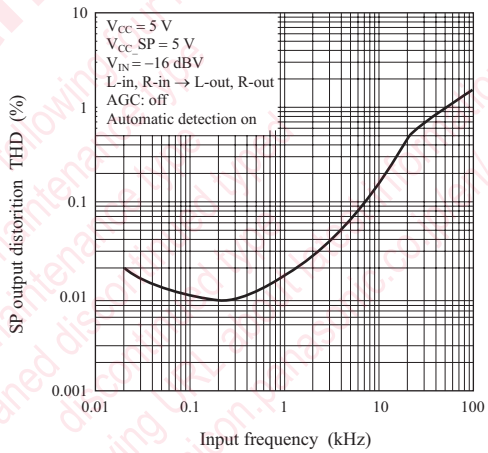

■ Technical data (continued)

2. Main characteristics (continued)

1) SP amplifier (continued)

(2) Beep → L-out, R-out mode

SP I/O characteristics — 8Ω

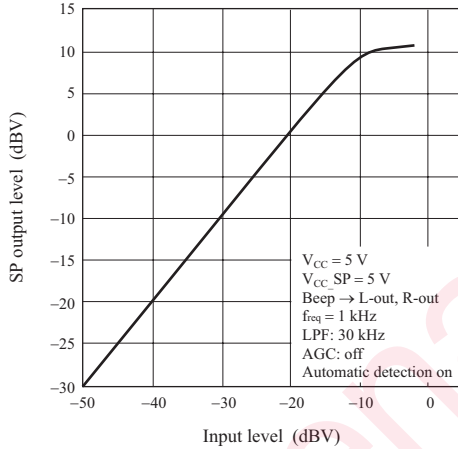

SP I/O characteristics — 8Ω

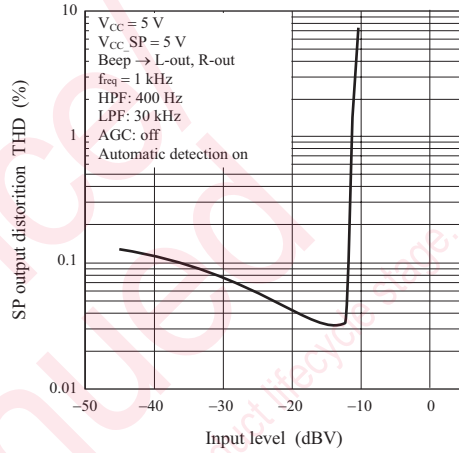

SP output frequency characteristics — 8Ω

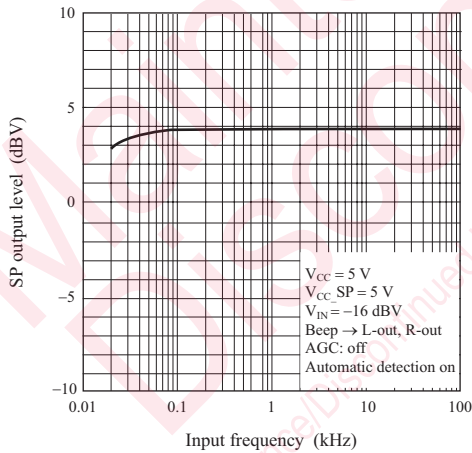

SP output frequency characteristics — 8Ω

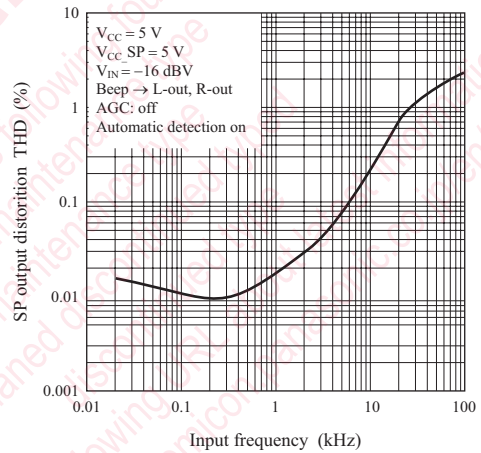

■ Technical data (continued)

2. Main characteristics (continued)

2) Mix amplifier 1

(1) L-in,R-in → L-out,R-out mode

Mix amplifier 1 system I/O characteristics

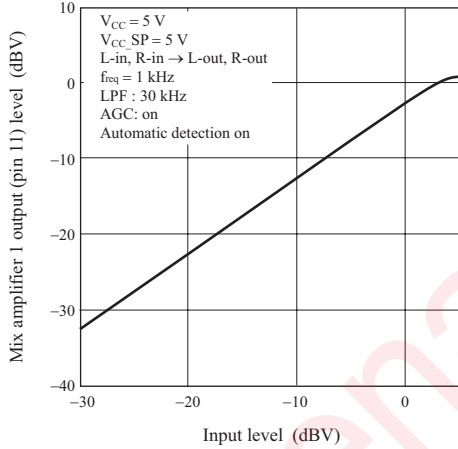

Mix amplifier 1 system I/O distortion characteristics

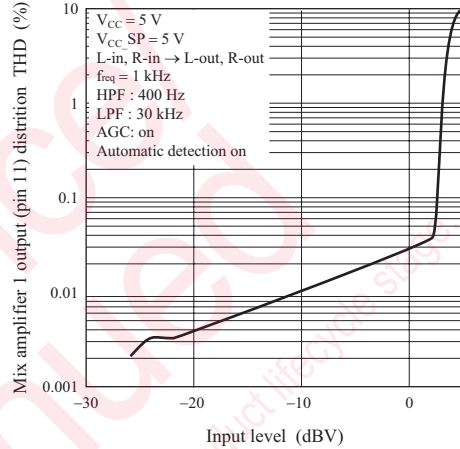

Mix amplifier 1 system

I/O characteristics frequency characteristics

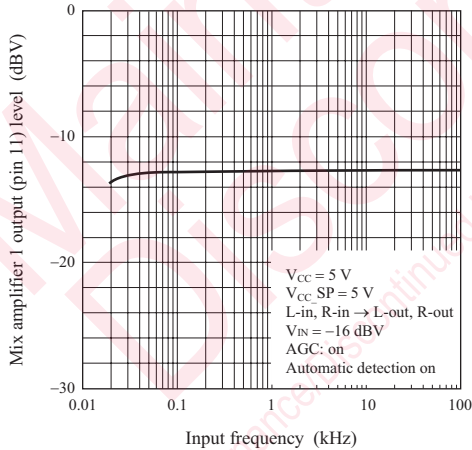

Mix amplifier 1 system

I/O characteristics frequency characteristics

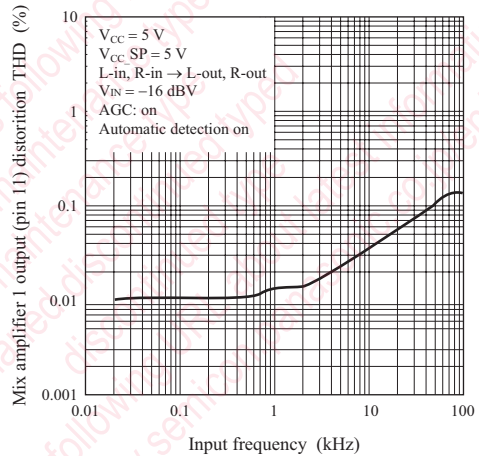

■ Technical data (continued)

2. Main characteristics (continued)

3) Mix amplifier 2

(1) Alarm → L-out,R-out mode

Mix amplifier 1 system

I/O characteristics

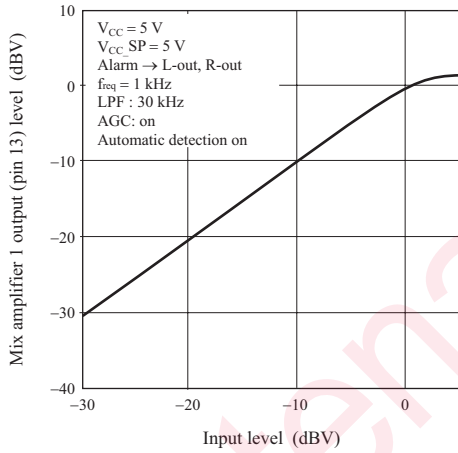

Mix amplifier 2 system

I/O distortion characteristics

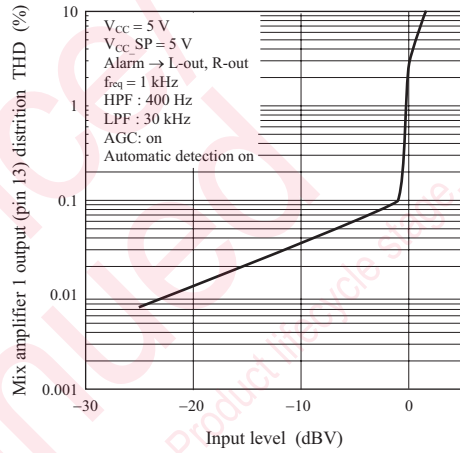

Mix amplifier 2 system

I/O characteristics frequency characteristics

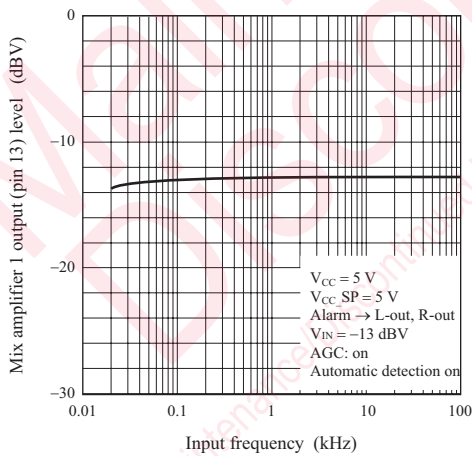

Mix amplifier 2 system

I/O characteristics frequency characteristics

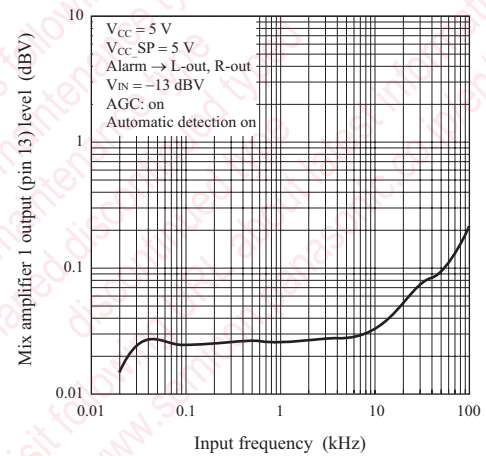

■ Technical data (continued)

2. Main characteristics (continued)

4) Pre-amplifier

(1) R-in → Pin 50 mode

Signal detection system  
I/O characteristics

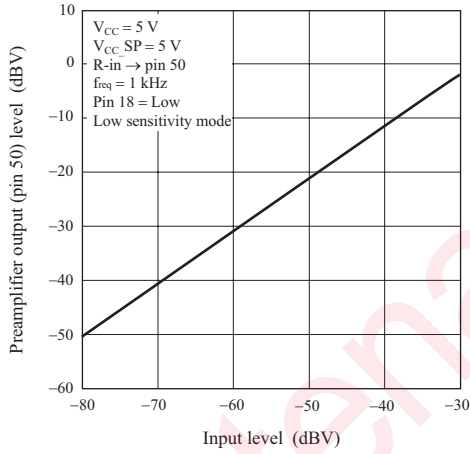

Signal detection system  
pre-amplifier frequency characteristics

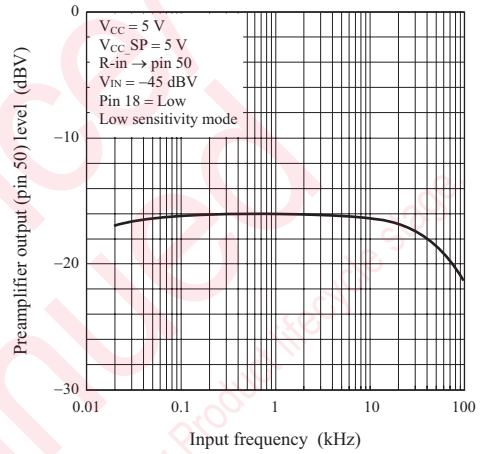

Signal detection system  
I/O characteristics

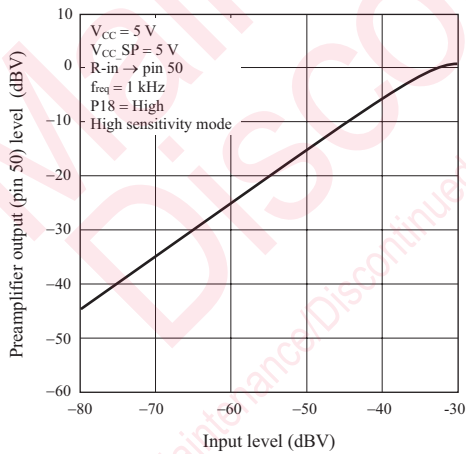

Signal detection system  
pre-amplifier I/O distorted characteristics

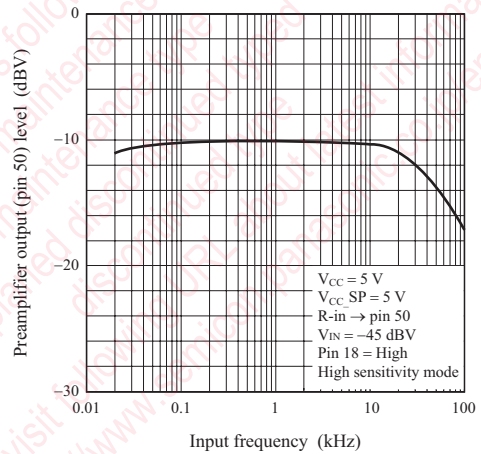



■ Technical data (continued)

2. Main characteristics (continued)

5) AGC

(1) L-in,R-in → L-out,R-out mode

AGC I/O characteristics

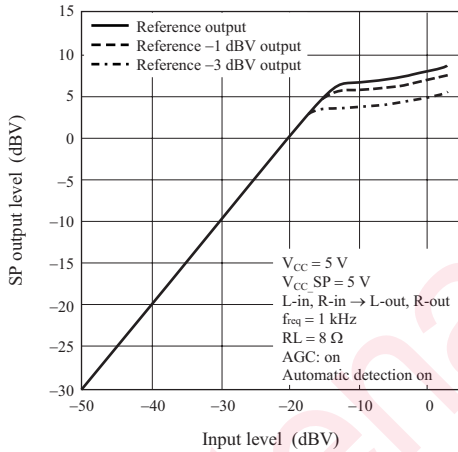

AGC output distortion characteristics

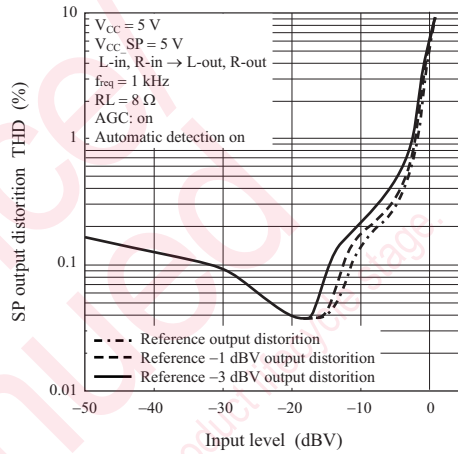

AGC frequency distortion characteristics

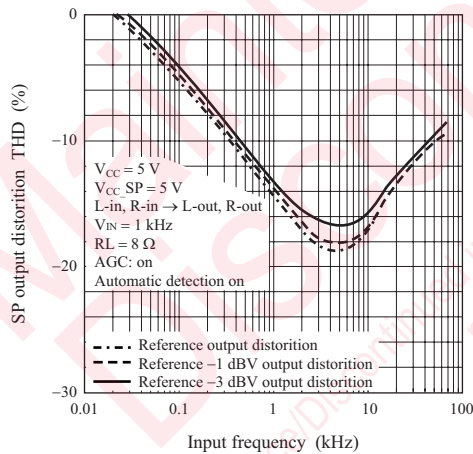

Beep: AGC frequency distortion characteristics

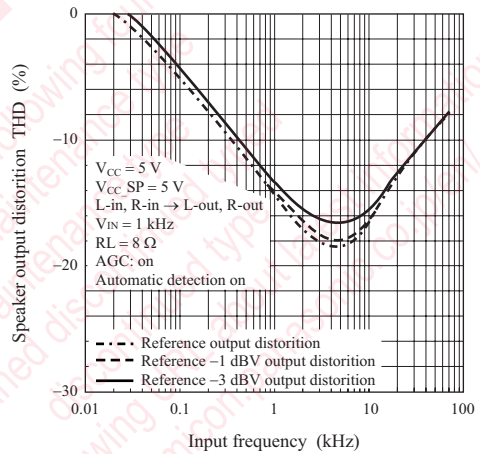

(2) Beep → L-out,R-out mode

Beep: AGC I/O characteristics

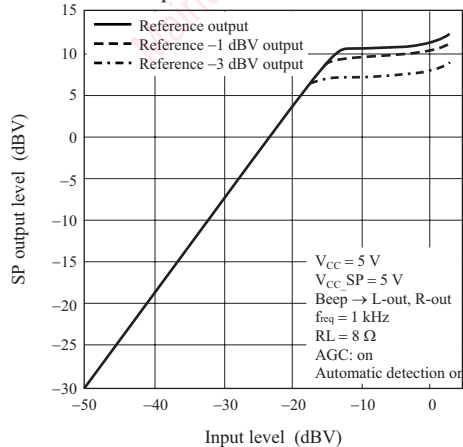

Beep: AGC output distortion characteristics

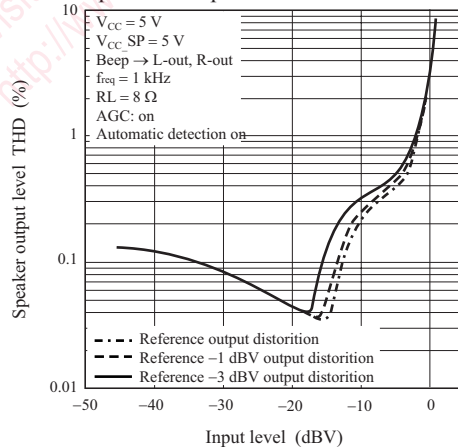

**■ Usage Notes**

1. Avoid the power line short and the ground short of the pins.
2. Especially positive phase speaker output pins (pin 24, pin 25, pin 32 and pin 33) and reverse phase speaker output pins (pin 26, pin 27, pin 30 and pin 31) have the possibility of break-down caused by the power line short and the ground short. Be sure to avoid power line short, ground short and load short.

Maintenance/Discontinued

Maintenance/Discontinued includes following four Product lifecycle stage.  
planned maintenance type  
maintenance type  
planned discontinued type  
discontinued type  
Please visit following URL about latest information.  
<http://www.semicon.panasonic.co.jp/en/>

## Request for your special attention and precautions in using the technical information and semiconductors described in this book

- (1) If any of the products or technical information described in this book is to be exported or provided to non-residents, the laws and regulations of the exporting country, especially, those with regard to security export control, must be observed.
- (2) The technical information described in this book is intended only to show the main characteristics and application circuit examples of the products, and no license is granted under any intellectual property right or other right owned by our company or any other company. Therefore, no responsibility is assumed by our company as to the infringement upon any such right owned by any other company which may arise as a result of the use of technical information described in this book.
- (3) The products described in this book are intended to be used for standard applications or general electronic equipment (such as office equipment, communications equipment, measuring instruments and household appliances).  
Consult our sales staff in advance for information on the following applications:
  - Special applications (such as for airplanes, aerospace, automobiles, traffic control equipment, combustion equipment, life support systems and safety devices) in which exceptional quality and reliability are required, or if the failure or malfunction of the products may directly jeopardize life or harm the human body.
  - Any applications other than the standard applications intended.
- (4) The products and product specifications described in this book are subject to change without notice for modification and/or improvement. At the final stage of your design, purchasing, or use of the products, therefore, ask for the most up-to-date Product Standards in advance to make sure that the latest specifications satisfy your requirements.
- (5) When designing your equipment, comply with the range of absolute maximum rating and the guaranteed operating conditions (operating power supply voltage and operating environment etc.). Especially, please be careful not to exceed the range of absolute maximum rating on the transient state, such as power-on, power-off and mode-switching. Otherwise, we will not be liable for any defect which may arise later in your equipment.
  - Even when the products are used within the guaranteed values, take into the consideration of incidence of break down and failure mode, possible to occur to semiconductor products. Measures on the systems such as redundant design, arresting the spread of fire or preventing glitch are recommended in order to prevent physical injury, fire, social damages, for example, by using the products.
- (6) Comply with the instructions for use in order to prevent breakdown and characteristics change due to external factors (ESD, EOS, thermal stress and mechanical stress) at the time of handling, mounting or at customer's process. When using products for which damp-proof packing is required, satisfy the conditions, such as shelf life and the elapsed time since first opening the packages.
- (7) This book may be not reprinted or reproduced whether wholly or partially, without the prior written permission of Matsushita Electric Industrial Co., Ltd.