

QT-Brightek Chip LED Series

SMD 0603 Yellow LED

Part No.: QBLP601-Y1

Product: QBLP601-Y1	Date: March 28, 2014	Page 1 of 9
	Version# 1.0	

Table of Contents

Introduction	3
Electrical / Optical Characteristic (T=25 °C)	4
Absolute Maximum Rating	4
Solder Profile & Footprint	6
Packing	7
Labeling	8
Ordering Information	8
Revision History	9
Disclaimer	9

Introduction

Feature:

- Water clear lens
- Package in tape and reel
- Ultra bright 0603 LED package
- GaAsP technology

Description:

These ultra bright 0603 LEDs have a height profile of 0.60mm. Combination of high brightness output and small footprint, these LEDs are ideal for keypad backlighting and status indication.

Application:

- Status indication
- Back lighting application

Certification & Compliance:

- TS16949
- ISO9001
- RoHS Compliant



Dimension:

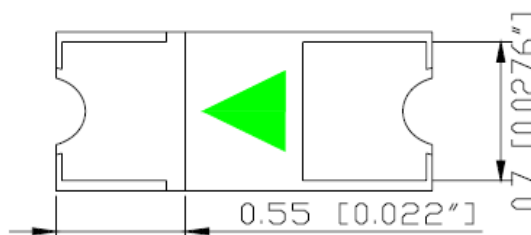
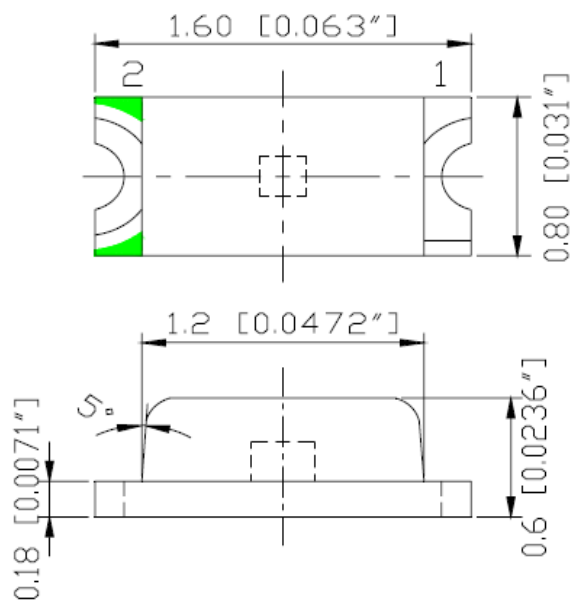

Units: mm / tolerance = +/-0.1mm

Electrical / Optical Characteristic (T=25 °C)

Product	Color	I _F (mA)	V _F (V)			λ _D (nm)			I _V (mcd)	
			Min.	Typ.	Max.	Min.	Typ.	Max.	Min.	Typ.
QBLP601-Y1	Yellow	10	1.6	-	2.5	585	---	595	-	4
		20	1.6	-	2.5				3.2	8

Absolute Maximum Rating

Material	P _d (mW)	I _F (mA)	I _{FP} (mA)*	V _R (V)	T _{OP} (°C)	T _{ST} (°C)	T _{SOL} (°C)**
GaAsP	80	30	100	5	-40 ~ +85	-40 ~ +100	260

*Duty 1/10 @ 10KHz

** IR Reflow for no more than 10 sec @ 260 °C

Forward Voltage V_F @ I_F=20mA

Bin	Min.	Max.	Unit
b	1.6	1.9	V
c	1.9	2.2	
d	2.2	2.5	

Luminous Intensity I_V @ I_F=20mA

Bin	Min.	Max.	Unit
7	3.2	5	mcd
8	5	8	
9	8	12.5	
A	12.5	16	

Dominant Wavelength λ_D @ I_F=20mA

Bin	Min.	Max.	Unit
m	585	590	nm
n	590	595	

Characteristic Curves

GaAsP

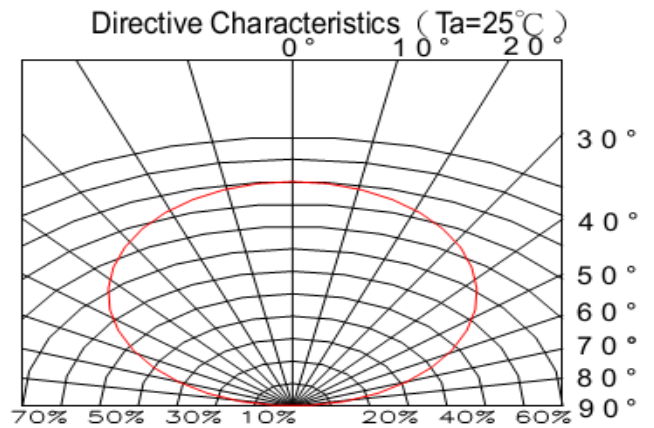
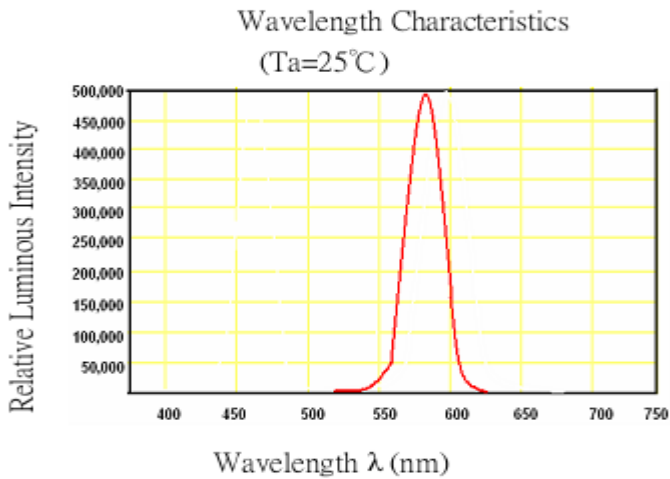
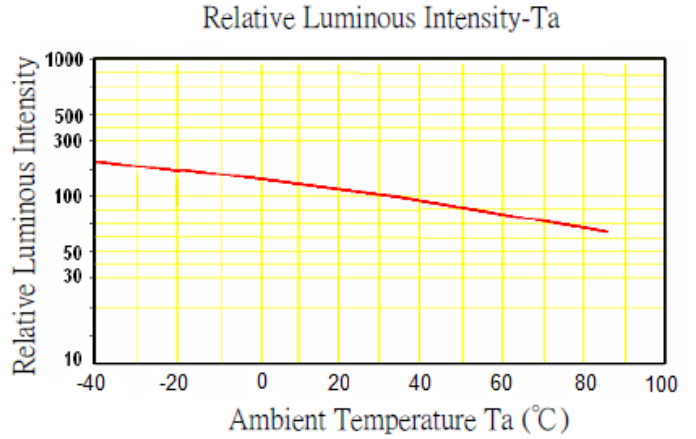
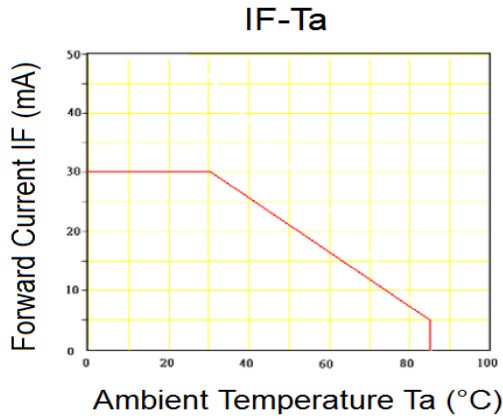
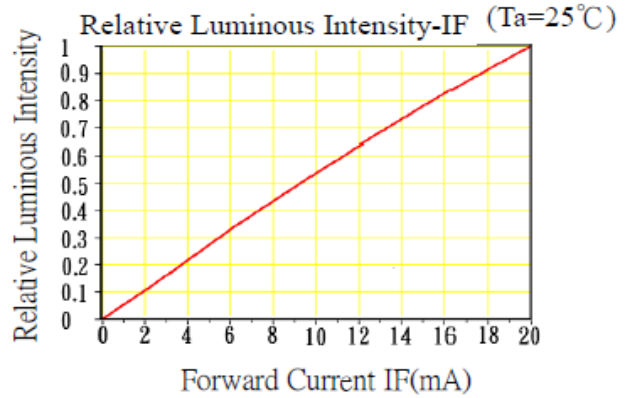
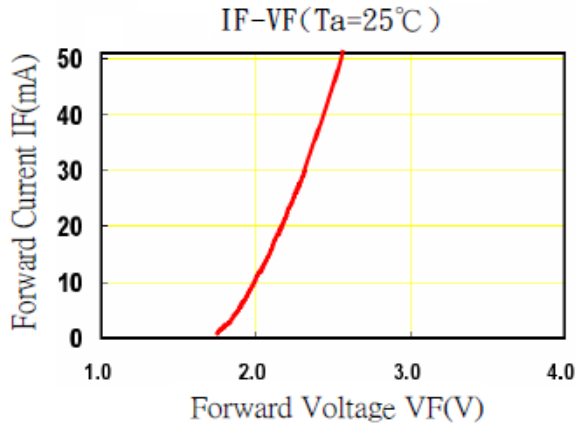

Solder Profile & Footprint

- Recommended tin solder specifications: melting temperature in the range of 178~192 °C
- The recommended reflow soldering profile is as follows (temperatures indicated are as measured on the surface of the LED resin):

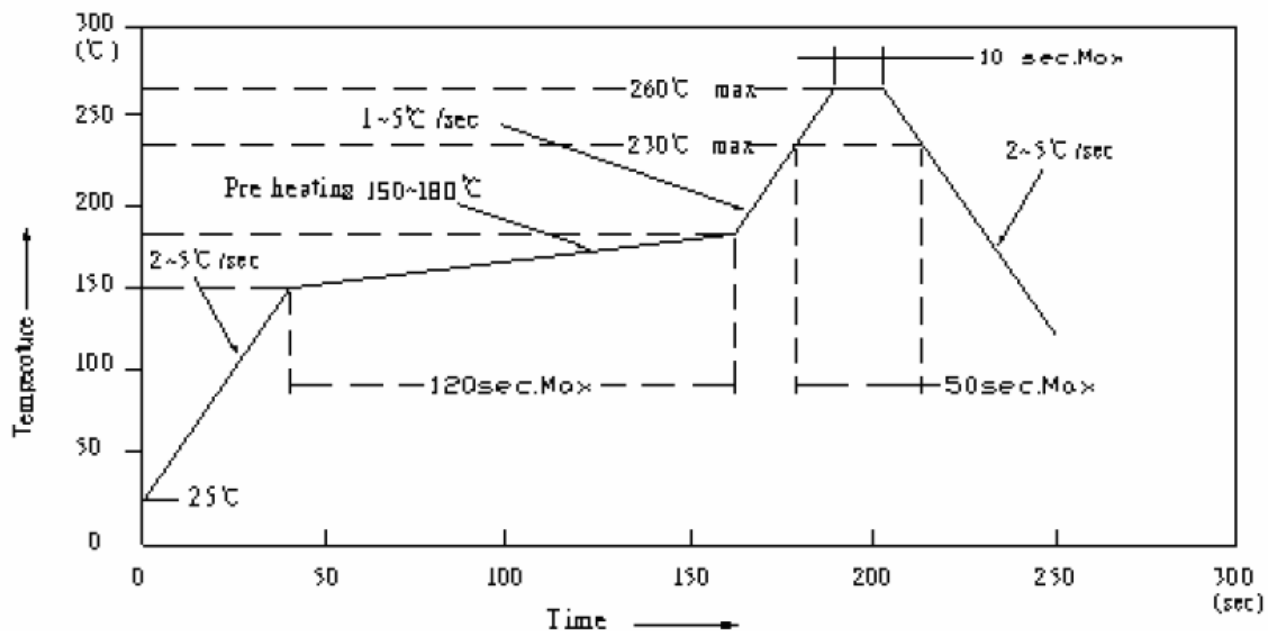

RECOMMEND PAD LAYOUT

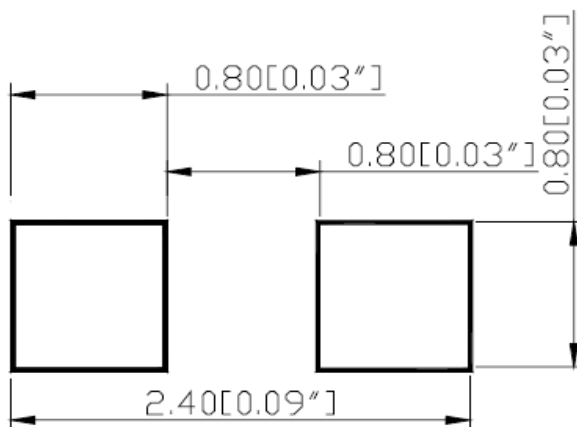

Units: mm

tolerance: +/- 0.1mm

Product: QBLP601-Y1	Date: March 28, 2014	Page 6 of 9
	Version# 1.0	

Packing

Reel Dimension:

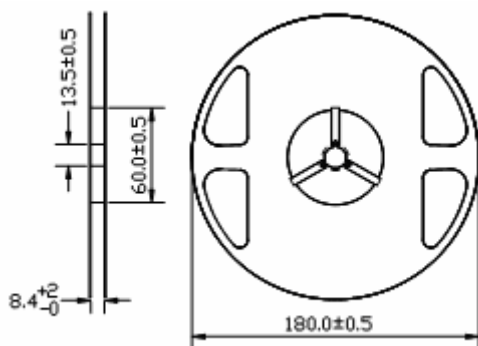

Unit: mm

Tape Dimension:

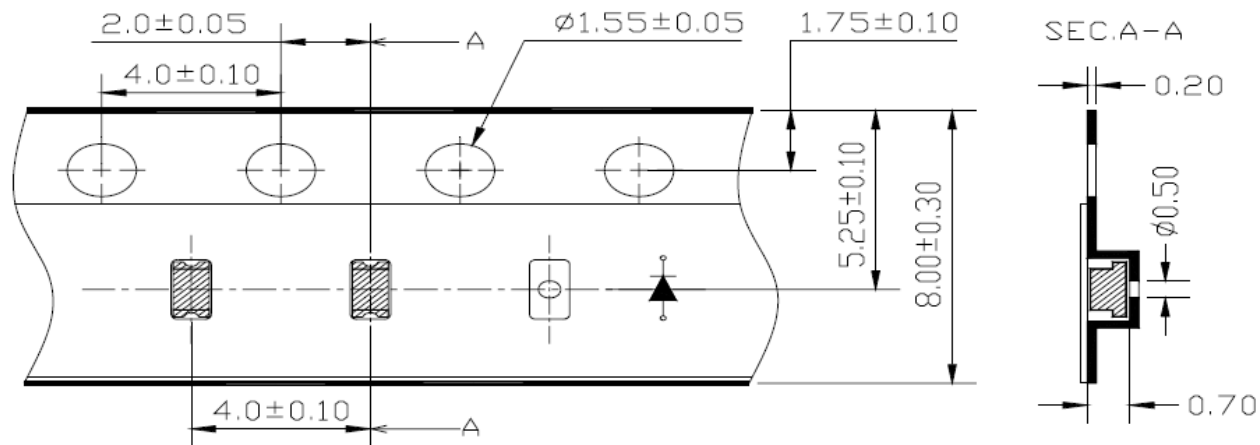

Unit: mm

Arrangement of Tape:

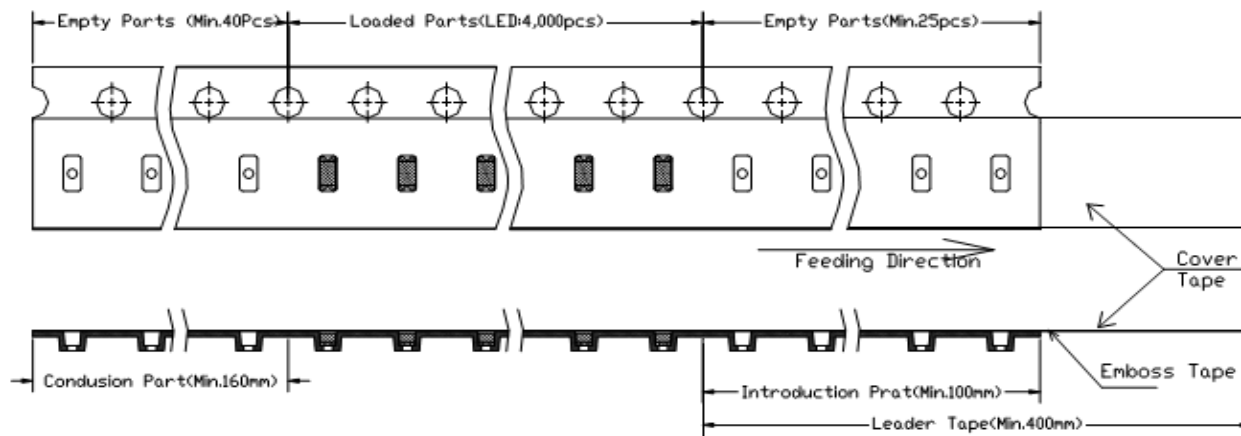

Packaging Specification:

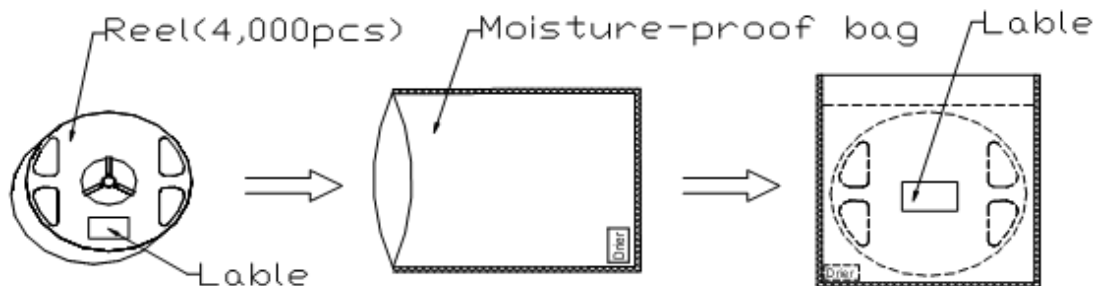

Labeling



Part No: _____
Customer P/N: _____
Item: _____
Q'ty: _____
Vf: _____
Iv: _____
WI: _____
Date: _____

Made in China

Ordering Information

Part #	Orderable Part #	Spec Range	Quantity per reel
QBLP601-Y1	QBLP601-Y1	Iv = 4 mcd Typ. @ I _F = 10mA; 8 mcd Typ. @ I _F = 20mA / Color = 568-595nm	4,000 units

Product: QBLP601-Y1	Date: March 28, 2014	Page 8 of 9
	Version# 1.0	

Revision History

Description:	Revision #	Revision Date
New Release of QBLP601-Y1	V1.0	03/28/2014

Disclaimer

QT-BRIGHTTEK reserves the right to make changes without further notice to any products herein to improve reliability, function or design. QT-BRIGHTTEK does not assume any liability arising out of the application or use of any product or circuit described herein; neither does it convey any license under its patent rights, nor the rights of others.

Life Support Policy

QT-BRIGHTTEK's products are not authorized for use as critical components in life support devices or systems without the express written approval of QT-BRIGHTTEK. As used herein:

1. Life support devices or systems are devices or systems which, (a) are intended for surgical implant into the body, or (b) support or sustain life, and (c) whose failure to perform when properly used in accordance with instructions for use provided in the labeling, can be reasonably expected to result in a significant injury of the user.
2. A critical component in any component of a life support device or system whose failure to perform can be reasonably expected to cause the failure of the life support device or system, or to affect its safety or effectiveness.

Product: QBLP601-Y1	Date: March 28, 2014	Page 9 of 9
	Version# 1.0	