

## Rectifier Diodes

### S1AFH~S1MFH

#### ■ Features

- Surface Mount General Purpose Silicon Rectifiers
- Reverse Voltage - 50 to 1000 V
- Forward Current: 1 A

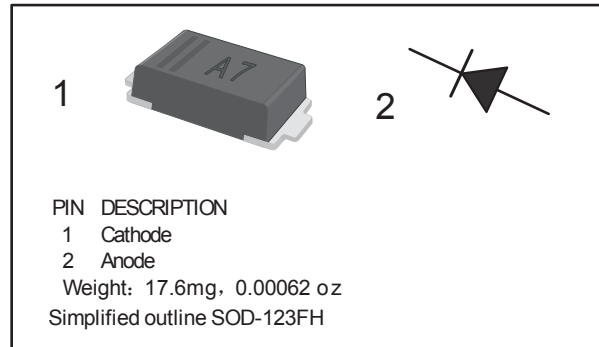

#### ■ Absolute Maximum Ratings Ta = 25°C

Parameter	Symbol	S1AFH	S1BFH	S1DFH	S1GFH	S1JFH	S1KFH	S1MFH	Unit	
Repetitive Peak reverse voltage	VRRM	50	100	200	400	600	800	1000	V	
Surge Peak reverse voltage	VSRM	35	70	140	280	420	560	700		
Maximum DC Blocking Voltage	VDC	50	100	200	400	600	800	1000		
Forward voltage @IF=1A	VF	1.1								A
Averaged forward current. @ Ta=65°C	IFAV	1								
Peak forward surge current	IFSM	25								
Maximum DC Reverse Current Ta=25°C Ta=125°C	IR	5								μA
		100								
Typical Junction Capacitance *1	Cj	4								pF
Thermal Resistance Junction to Ambient *2	RθJA	180								°C/W
Junction temperature	Tj	150								°C
Storage temperature	Tstg	-55 to 150								

\* 1 Measured at 1 MHz and applied reverse voltage of 4 V D.C

\* 2 Thermal resistance from junction to ambient at 0.375" (9.5 mm) lead length, P.C.B. mounted

#### ■ Marking

NO.	S1AFH	S1BFH	S1DFH	S1GFH	S1JFH	S1KFH	S1MFH
Marking	A1	A2	A3	A4	A5	A6	A7

# Rectifier Diodes

## S1AFH~S1MFH

■ Typical Characteristics

Fig.1 Forward Current Derating Curve

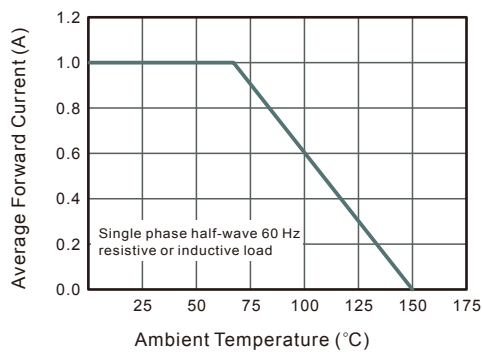

Fig.2 Typical Instaneous Reverse Characteristics

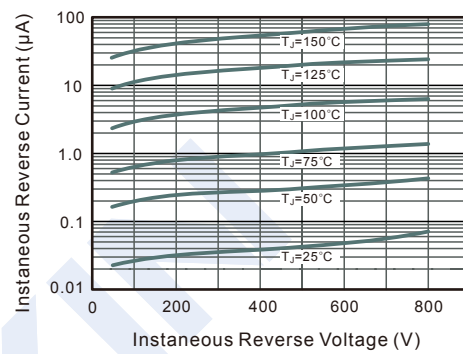

Fig.3 Typical Forward Characteristic

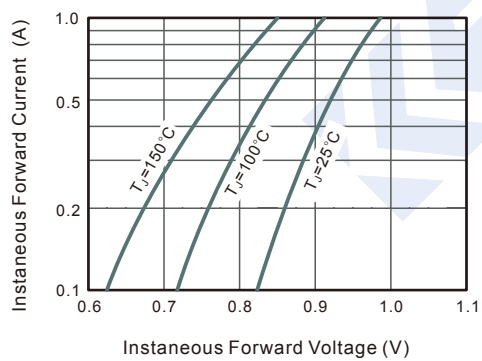
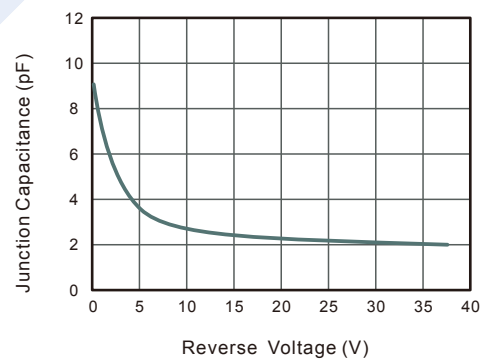

Fig.4 Typical Junction Capacitance



## Rectifier Diodes S1AFH~S1MFH

■ Typical Application

Plastic surface mounted package; 2 leads

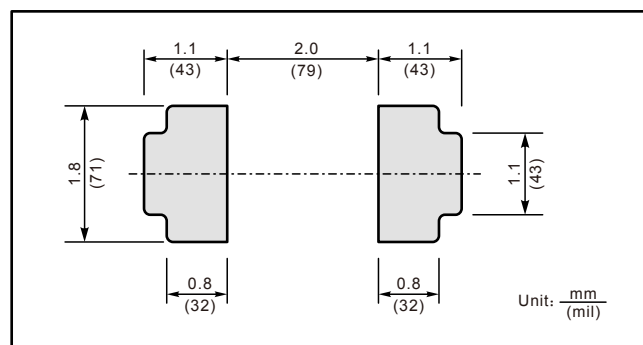
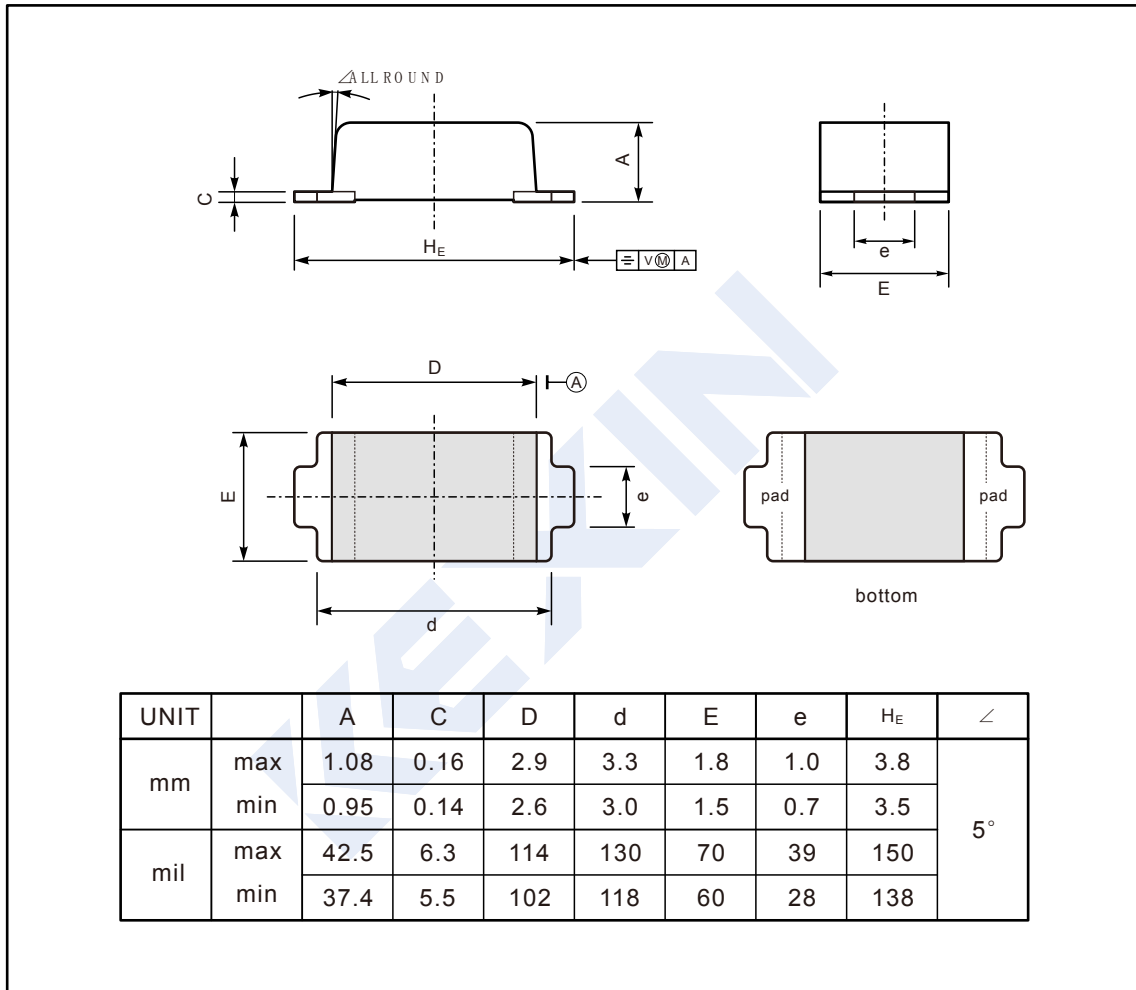

## Rectifier Diodes

### S1AFH~S1MFH

#### ■ Typical Application

#### Recommended condition of flow soldering

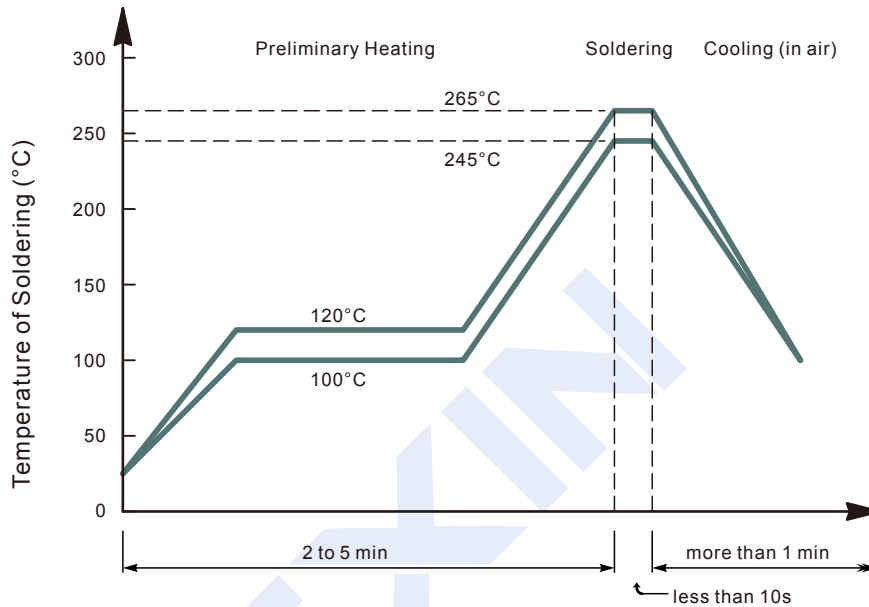

#### Recommended condition of reflow soldering

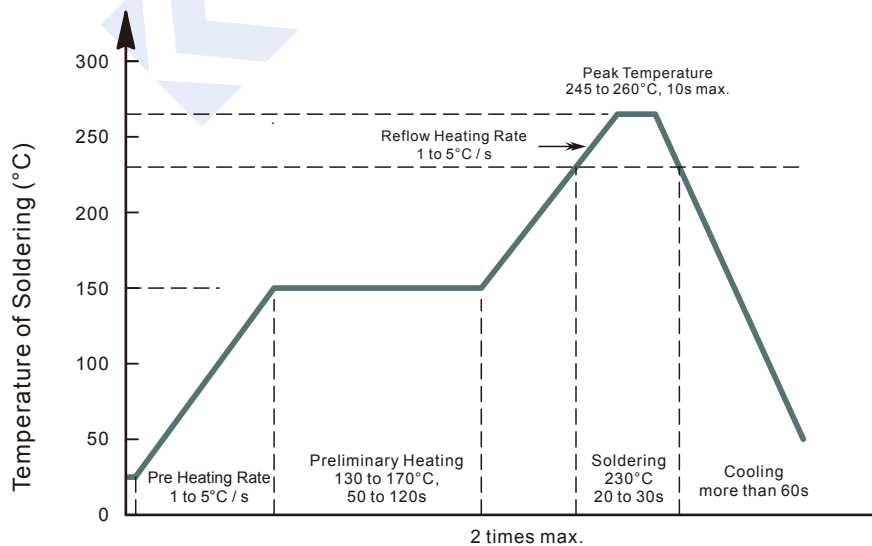

Recommended peak temperature is over 245 °C. If peak temperature is below 245 °C, you may adjust the following parameters; time length of peak temperature (longer), time length of soldering (longer), thickness of solder paste (thicker)