

251/253 Series, PICO® II Very Fast-Acting Fuse



Description

The PICO® II Very Fast-Acting Fuse is designed to meet an extensive array of performance characteristics in a space-saving subminiature package.

Features







- Very fast-acting
- Small size
- Wide current rating range (0.062A- 15A)
- Halogen-free available
- Wide operating temperature range
- Low temperature re-rating

Applications

Secondary protection for space constrained applications

- Flat-panel display TV
- LCD monitor
- LCD backlight inverter
- Office machines
- Power supply
- Audio/Video system
- Lighting system
- Medical equipment

Agency Approvals

Agency	Agency File Number 253 Series	Agency File Number 251 Series	Ampere Range
	N/A	E10480	0.062A - 15A
	N/A	29862	0.062A - 15A
	N/A	JET1896-31007-1004	1A - 5A
	N/A	J50158379	0.500A - 10A
	FM10	N/A	0.062A - 15A
	N/A	2009010207366577	0.500A, 1A, 2A, 2.5A, 3A, 4A, 5A

Electrical Characteristics for Series

% of Ampere Rating	Ampere Rating	Opening Time
100%	0.062A - 15A	4 Hours, Min.
200%	0.062A - 7A	1 Second, Max.
	10A	3 Seconds, Max.
	12 - 15A	10 Seconds, Max.
275%	0.500A, 1A, 2A, 2.5A, 3A, 4A, 5A, 7A, 10A	300 msec., Max.
400%	0.05A, 1A, 2A, 2.5A, 3A, 4A, 5A, 7A, 10A	30 msec., Max.
1000%	0.500A, 1A, 2A, 2.5A, 3A, 4A, 5A, 7A, 10A	4 msec., Max.

Additional Information



**Datasheet
251 Series**



**Resources
251 Series**



**Samples
251 Series**



**Datasheet
253 Series**









**Resources
253 Series**



**Samples
253 Series**

Electrical Specifications by Item

Ampere Rating (A)	Amp Code	Ordering Number (Std.)	Ordering Number (Mil.)	Max Voltage Rating (V)	Interrupting Rating	Nominal Cold Resistance (Ohms)	Nominal Melting I ² t (A ² sec)	Nom Voltage Drop (V)	Agency Approvals					
													 253 Series Only	
.062	.062	251.062	253.062	125	300 A @ 125VDC 50A@125VAC	7.000	0.000113	1.4	x	x			x	
.125	.125	251.125	253.125	125		1.700	0.00174	0.285	x	x			x	
.200	.200	251.200	253.200	125		0.895	0.0048	0.345	x	x				
.250	.250	251.250	253.250	125		0.665	0.0116	0.24	x	x			x	
.375	.375	251.375	253.375	125		0.395	0.0296	0.215	x	x			x	
.500	.500	251.500	253.500	125		0.302	0.0598	0.2165	x	x		x	x	x
.630	.630	251.630		125		0.205	0.08	0.188	x	x				
.750	.750	251.750	253.750	125		0.175	0.153	0.176	x	x		x	x	
1.00	001.	251001.	253001.	125		0.128	0.256	0.194	x	x	x	x	x	x
1.25	1.25	2511.25		125		0.100	0.390	0.2	x	x	x			
1.50	01.5	25101.5	25301.5	125		0.0823	0.587	0.21	x	x	x	x	x	
2.00	002.	251002.	253002.	125		0.0473	0.405	0.141	x	x	x	x	x	x
2.50	02.5	25102.5		125		0.0360	0.721	0.132	x	x	x	x		x
3.00	003.	251003.	253003.	125		0.0295	1.19	0.131	x	x	x	x	x	x
3.50	03.5	25103.5		125		0.0240	1.58	0.1205	x	x	x	x		
4.00	004.	251004.	253004.	125		0.0204	2.45	0.114	x	x	x	x	x	x
5.00	005.	251005.	253005.	125		0.0158	4.14	0.11	x	x	x	x	x	x
7.00	007.	251007.	253007.	125		0.0107	10.4	0.102	x	x		x	x	
10.0	010.	251010.	253010.	125	0.0072	25.5	0.1	x	x		x	x		
12.0	012.	251012.		32	300A@32VDC & 50A@32VAC	0.0059	45.2	0.0878	x	x				
15.0	015.	251015.	253015.	32		0.00446	68.8	0.071	x	x			x	

Note: Higher ampere ratings are available. Please contact Littelfuse Technical Support or your Littelfuse products representative for assistance.

Temperature Re-rating Curve

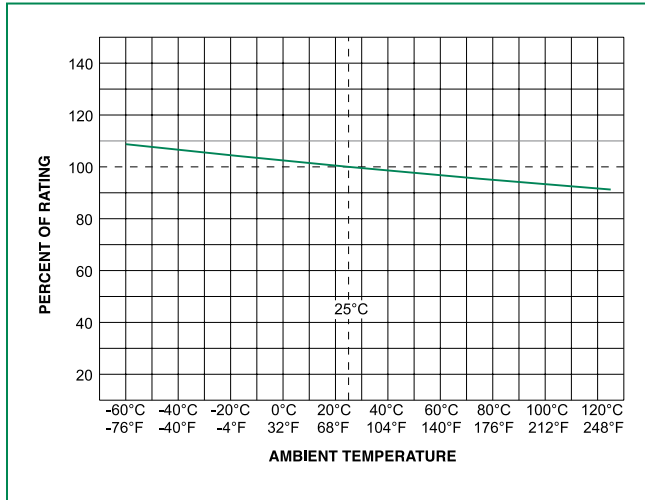

Note:

1. Re-rating depicted in this curve is in addition to the standard derating of 25% for continuous operation.

Soldering Parameters

Recommended Process Parameters:

Wave Parameter	Lead-Free Recommendation for 251 Series only
Preheat: (Depends on Flux Activation Temperature)	(Typical Industry Recommendation)
Temperature Minimum:	100°C
Temperature Maximum:	150°C
Preheat Time:	60-180 seconds
Solder Pot Temperature:	260°C Maximum
Solder Dwell Time:	2-5 seconds

Recommended Hand Soldering Parameters:

Solder Iron Temperature: 350°C +/- 5°C
 Heating Time: 5 seconds max.

Note: These devices are not recommended for IR or Convection Reflow process

Average Time Current Curves

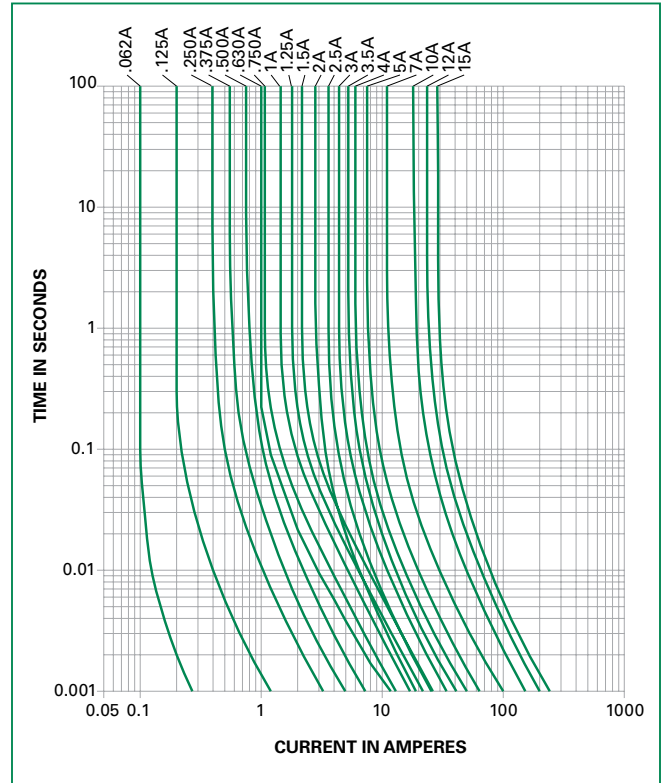

Product Characteristics

Materials	Encapsulated, Epoxy-Coated Body: Pure Tin-coated Copper wire leads
Solderability	MIL-STD-202, Method 208
Lead Pull Force	MIL-STD-202, Method 211, Test Condition A (will withstand a 7lbs. axial pull test)
Fuses To MIL SPEC	For fuses to MIL-PRF-23419, FM10 change the series number from 251 to 253
Operating Temperature	-55°C to +125°C (Consider re-rating)

Vibration	MIL-STD-202, Method 201 (10–55 Hz); Method 204, Test Condition C (55–2000 Hz at 10 G's Peak)
Shock	MIL-STD-202, Method 213, Test Condition I (100 G's peak for 6 msec.)
Insulation Resistance (After Opening):	MIL-STD-202, Method 302, Test Condition A (10,000 ohms minimum at 100 volts)
Moisture Resistance	MIL-STD-202, Method 106
Resistance to Soldering Heat	Withstands 60 seconds above 200°C and up to 260°C, maximum
Flammability Rating	UL 94V-0

Dimensions

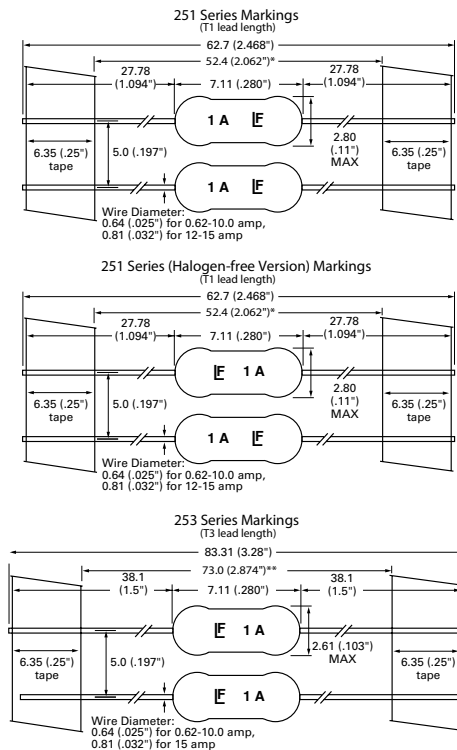

Part Numbering System

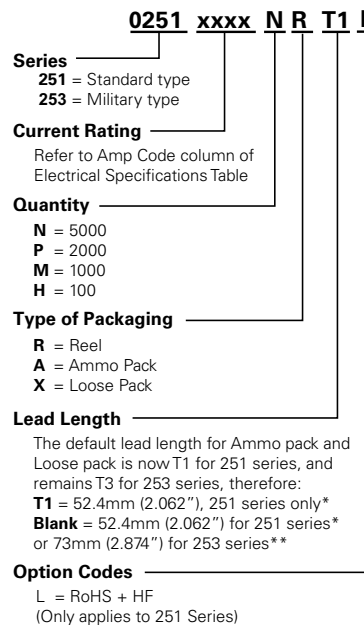

Packaging

Packaging Option	Packaging Specification	Quantity & Packaging Code
*T1: 52.4mm (2.062") Tape and Reel	EIA 296	Please refer to available quantities above in "Part Numbering System"
**T3: 73mm (2.874") Tape and Reel	EIA 296	

The default lead length for both ammo pack and loose pack is T1 for 251 and is T3 for 253.

Notes: * T1 dimension is defined as the length of the component between the two tapes. The full component length is 62.7mm (2.468"). **T1 length is for 251 series only.**
** T3 dimension is defined as the length of the component between the two tapes. The full component length is 83.37mm (3.28"). **T3 length is for 253 series only.**