

TGA2575

Ka-Band 3 Watt Power Amplifier

Applications

- Military Radar
- Communications

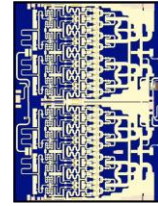

Product Features

- Frequency Range: 32.0 – 38.0 GHz
- Power: 35.5 dBm Psat
- PAE: 22%
- Gain: 19 dB
- Return Loss: 12 dB
- Bias: $V_d = 6\text{ V}$, $I_d = 2.1\text{ A}$, $V_g = -0.60\text{ V}$ Typical
- Dimensions: 5.4 x 4.1 x 0.05 mm

General Description

TriQuint's TGA2575 is a wideband power amplifier fabricated on TriQuint's production-released 0.15um pwr-pHEMT process. Operating from 32 GHz to 38 GHz, it achieves 35.5 dBm saturated output power, 22% PAE and 19 dB small signal gain over most of the band.

Fully matched to 50 ohms, ROHS compliant and with integrated DC blocking caps on both I/O ports, the TGA2575 is ideally suited to support both commercial and defense related opportunities.

The TGA2575 is 100% DC and RF tested on-wafer to ensure compliance to performance specifications.

Functional Block Diagram

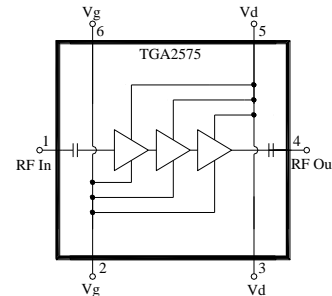

Bond Pad Configuration

Bond Pad #	Symbol
1	RF In
2, 6	V_g
3, 5	V_d
4	RF Out

Ordering Information

Part No.	ECCN	Description
TGA2575	3A001.b.2.d	Ka-band Power Amplifier

TGA2575

Ka-Band 3 Watt Power Amplifier

Specifications

Absolute Maximum Ratings

Parameter	Rating
Drain Voltage, Vd	+6.5 V
Gate Voltage, Vg	-5 to 0 V
Drain to Gate Voltage, Vd-Vg	10
Drain Current, Id	3.8 A
Gate Current, Ig	-14 to 4.8 mA
Power Dissipation, Pdiss	21 W
RF Input Power, CW, 50Ω, T = 25°C	23 dBm
Channel Temperature, Tch	200 °C
Mounting Temperature (30 Seconds)	320 °C
Storage Temperature	-40 to 150 °C

Operation of this device outside the parameter ranges given above may cause permanent damage. These are stress ratings only, and functional operation of the device at these conditions is not implied.

Recommended Operating Conditions

Parameter	Min	Typical	Max	Units
Vd		6		V
Id		2.1		A
Id_drive (Under RF Drive)		3.3		A
Vg		-0.60		V

Electrical specifications are measured at specified test conditions. Specifications are not guaranteed over all recommended operating conditions.

Electrical Specifications

Test conditions unless otherwise noted: 25°C, Vd = 6 V, Id = 2.1 A, Vg = -0.60 V Typical.

Parameter	Min	Typical	Max	Units
Operational Frequency Range	32		38	GHz
Gain: 32 – 35 GHz	17	19		dB
Gain: 36 – 85 GHz	15	17		
Input Return Loss		12		dB
Output Return Loss		12		dB
Output Power @ Saturation: 32 – 35 GHz	34.5	35.5		dBm
Output Power @ Saturation: 36 – 38 GHz	33	34.5		
PAE @ Saturation		22		%

Specifications (cont.)

Thermal and Reliability Information

Parameter	Condition	Rating
Thermal Resistance, θ_{JC} , measured to back of package	Tbase = 70 °C	$\theta_{JC} = 6.2^{\circ}\text{C/W}$
Channel Temperature (Tch), and Median Lifetime (Tm)	Tbase = 70 °C, Vd = 6 V, Id = 2.1 A, Pdiss = 12.6 W	Tch = 148°C Tm = 1.3 E+6 Hours
Channel Temperature (Tch), and Median Lifetime (Tm) Under RF Drive	Tbase = 70 °C, Vd = 6 V, Id = 3.3 A, Pout = 36 dBm, Pdiss = 15.8 W	Tch = 168°C Tm = 1.5E+5 Hours

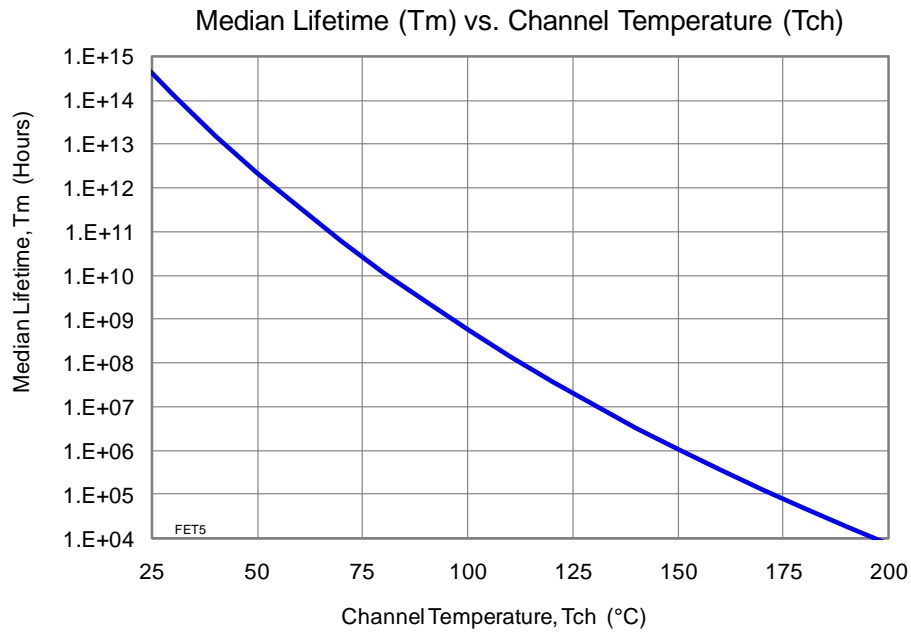

TGA2575

Ka-Band 3 Watt Power Amplifier



Typical Performance

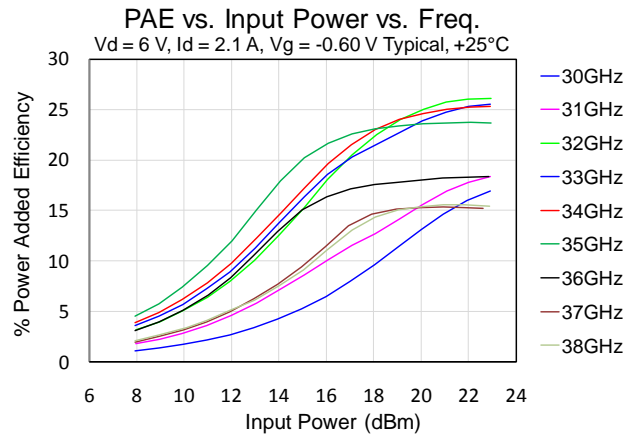
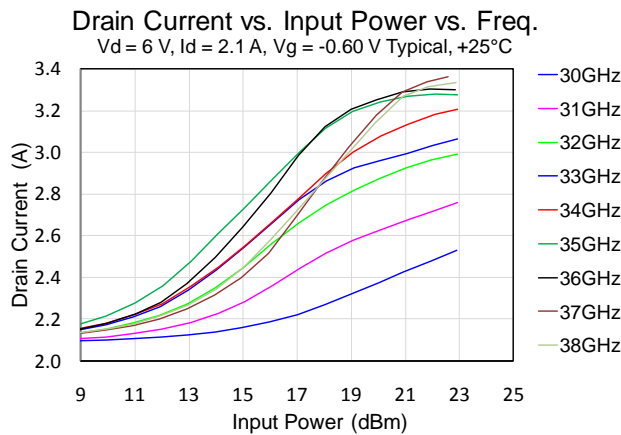
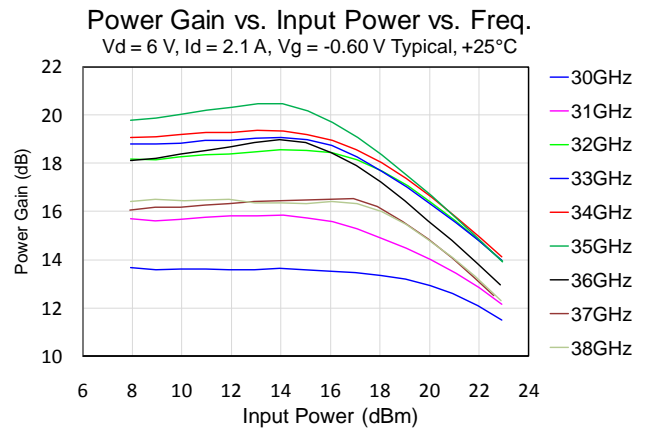
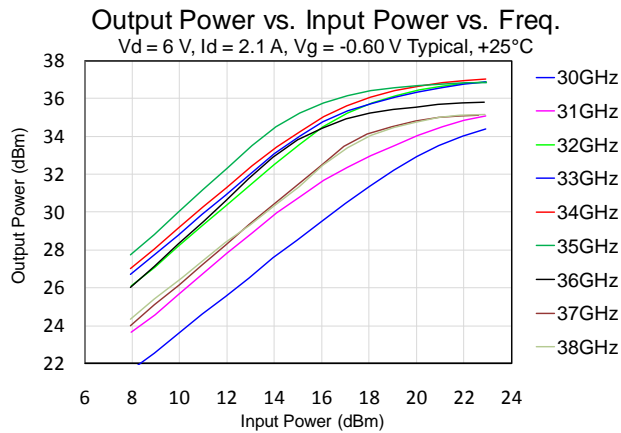
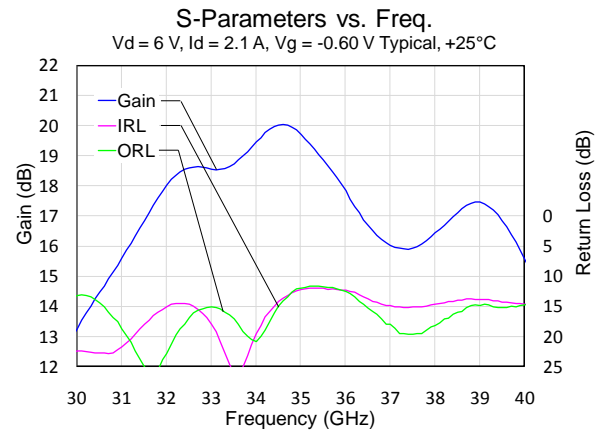
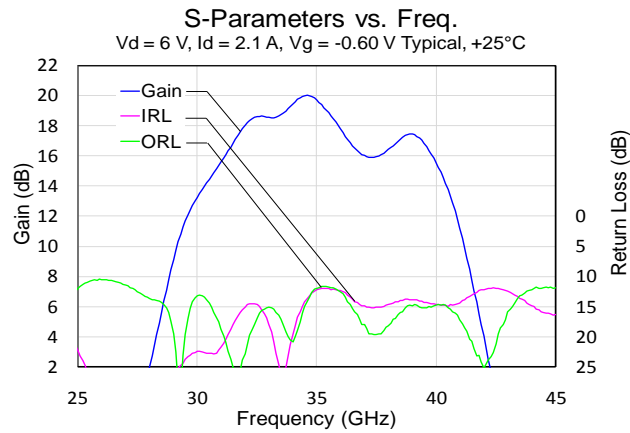

TGA2575

Ka-Band 3 Watt Power Amplifier



Typical Performance (cont.)

Output Power vs. Freq. vs. Input Power

Vd = 6 V, Id = 2.1 A, Vg = -0.60 V Typical, +25°C

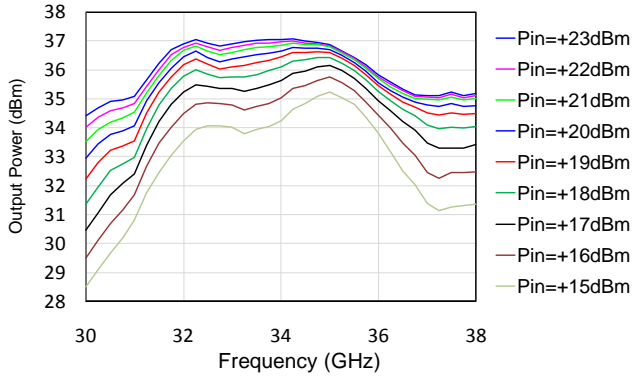

PAE vs. Freq. vs. Input Power

Vd = 6 V, Id = 2.1 A, Vg = -0.60 V Typical, +25°C

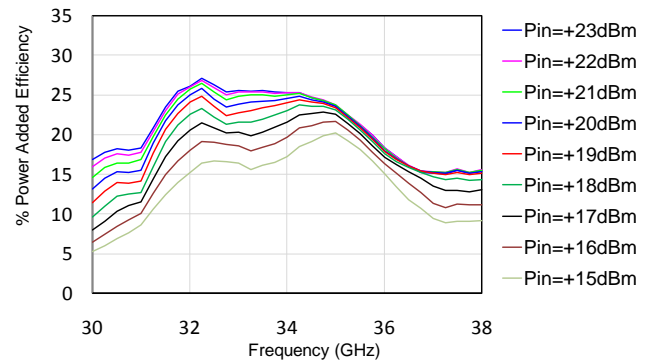

TGA2575

Ka-Band 3 Watt Power Amplifier

Application Circuit

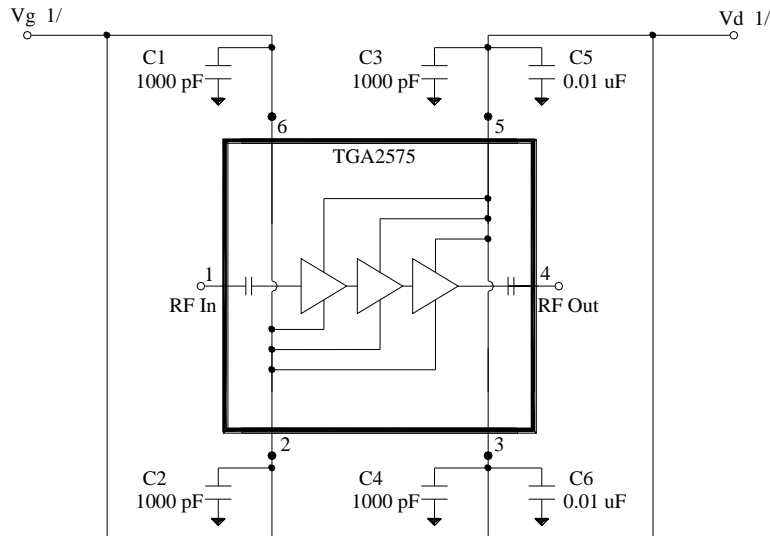

Vg must be biased from both sides (pins 2 and 6)
Vd must be biased from both sides (pins 3 and 5)

Bias-up Procedure

Vg set to -1.5 V
Vd set to +6 V
Adjust Vg more positive until quiescent Id is 2.1 A.
This will be ~ Vg = -0.60 V
Apply RF signal to RF Input

Bias-down Procedure

Turn off RF supply
Reduce Vg to -1.5V. Ensure Id ~ 0 mA
Turn Vd to 0 V
Turn Vg to 0 V

1/ Additional bypass capacitors may be required at this location. The presence and value of these capacitors varies by application. Variables include power supply impedance, power supply stability with reactive loads, and the inductance from the power supply to this assembly. 1 to 47 uF tantalum capacitors are commonly used here.

TGA2575

Ka-Band 3 Watt Power Amplifier

Bond Pad Description

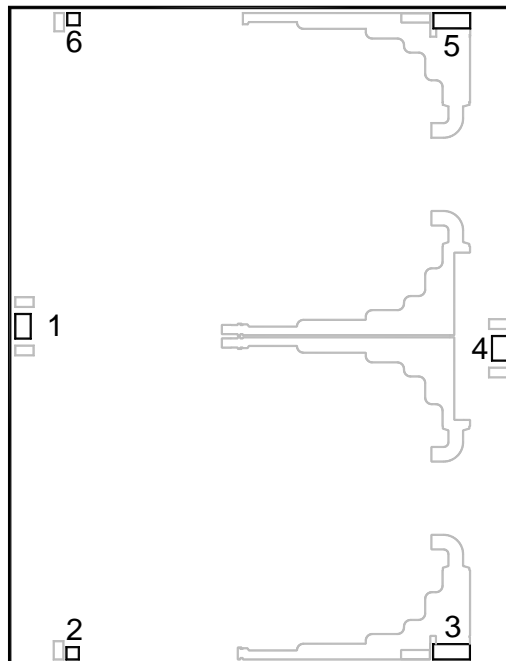

Bond Pad	Symbol	Description
1	RF In	Input, matched to 50 ohms.
2, 6	Vg	Gate voltage.
3, 5	Vd	Drain voltage.
4	RF Out	Output, matched to 50 ohms.
	GND	Backside of die.

Assembly Drawing

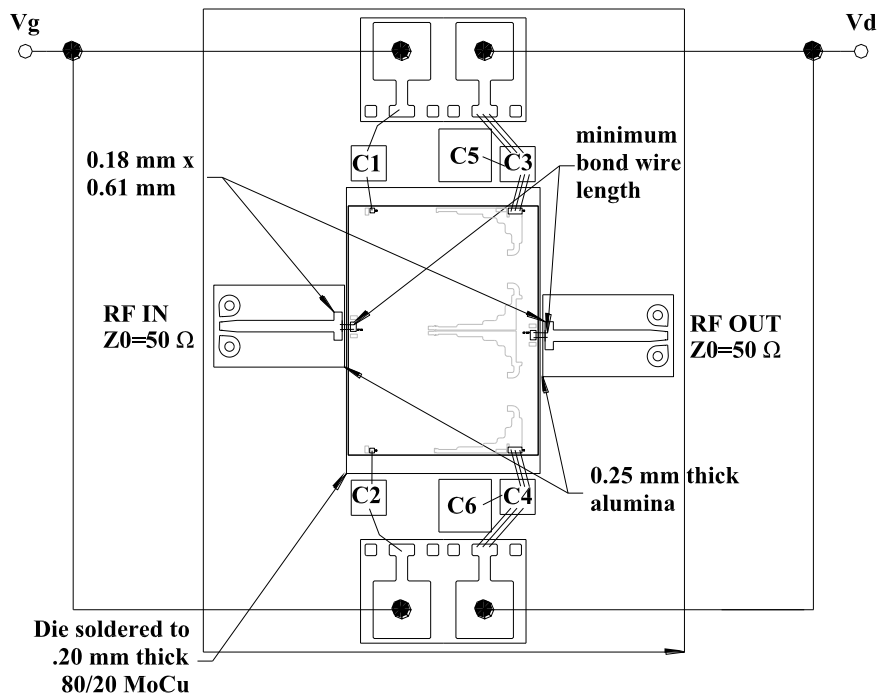

Bill of Material

Ref Des	Value	Description	Manufacturer	Part Number
C1, C2, C3, C4	100 pF	Cap, 50V, 25%, Single Layer Cap	various	
C5, C6	0.01 uF	Cap, 50V, 10%, SMD	various	

TGA2575

Ka-Band 3 Watt Power Amplifier

Mechanical Information

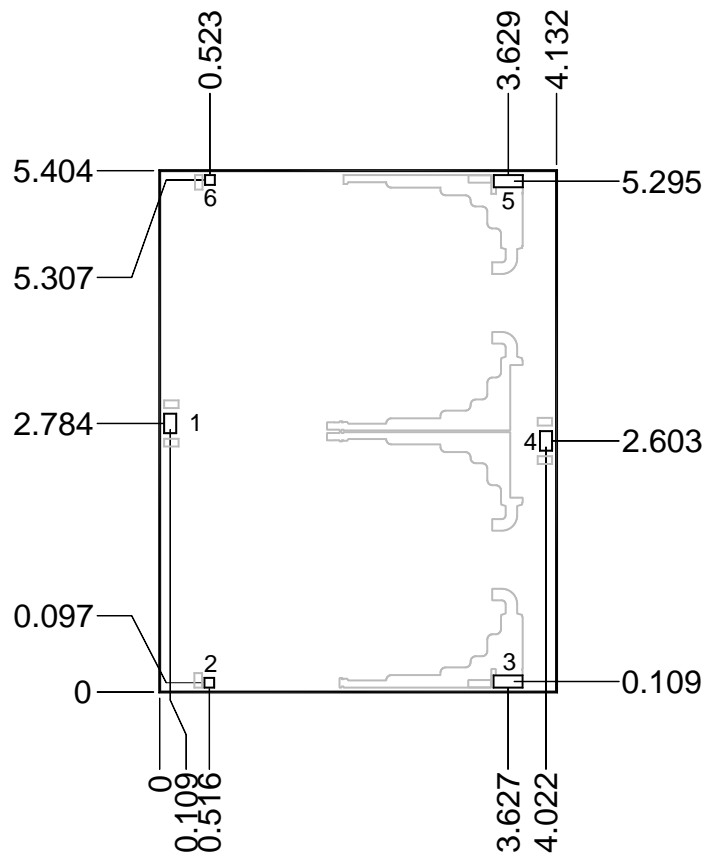

Unit: millimeters

Thickness: 0.05

Die x, y size tolerance: +/- 0.050

Chip edge to bond pad dimensions are shown to center of pad

Ground is backside of die

Bond Pad	Symbol	Pad Size
1	RF In	0.126 x 0.202
2, 6	V _g	0.101 x 0.101
3, 5	V _d	0.126 x 0.302
4	RF Out	0.126 x 0.202

Product Compliance Information

ESD Information



Caution! ESD-Sensitive Device

ESD Rating: TBD
Value: TBD
Test: Human Body Model (HBM)
Standard: JEDEC Standard JESD22-A114

ECCN

US Department of Commerce 3A001.b.2.d

Solderability

This part is compliant with EU 2002/95/EC RoHS directive (Restrictions on the Use of Certain Hazardous Substances in Electrical and Electronic Equipment).

This product also has the following attributes:

- Lead Free
- Halogen Free (Chlorine, Bromine)
- Antimony Free
- TBBP-A (C₁₅H₁₂Br₄O₂) Free
- PFOS Free
- SVHC Free

Assembly Notes

Component placement and adhesive attachment assembly notes:

- Vacuum pencils and/or vacuum collets are the preferred method of pick up.
- Air bridges must be avoided during placement.
- The force impact is critical during auto placement.
- Organic attachment (i.e. epoxy) can be used in low-power applications.
- Curing should be done in a convection oven; proper exhaust is a safety concern.

Reflow process assembly notes:

- Use AuSn (80/20) solder and limit exposure to temperatures above 300°C to 3-4 minutes, maximum.
- An alloy station or conveyor furnace with reducing atmosphere should be used.
- Do not use any kind of flux.
- Coefficient of thermal expansion matching is critical for long-term reliability.
- Devices must be stored in a dry nitrogen atmosphere.

Interconnect process assembly notes:

- Thermosonic ball bonding is the preferred interconnect technique.
- Force, time, and ultrasonics are critical parameters.
- Aluminum wire should not be used.
- Devices with small pad sizes should be bonded with 0.0007-inch wire.

TGA2575

Ka-Band 3 Watt Power Amplifier



Contact Information

For the latest specifications, additional product information, worldwide sales and distribution locations, and information about TriQuint:

Web: www.triquint.com
Email: info-sales@tqs.com

Tel: +1.972.994.8465
Fax: +1.972.994.8504

For technical questions and application information:

Email: info-products@tqs.com

Important Notice

The information contained herein is believed to be reliable. TriQuint makes no warranties regarding the information contained herein. TriQuint assumes no responsibility or liability whatsoever for any of the information contained herein. TriQuint assumes no responsibility or liability whatsoever for the use of the information contained herein. The information contained herein is provided "AS IS, WHERE IS" and with all faults, and the entire risk associated with such information is entirely with the user. All information contained herein is subject to change without notice. Customers should obtain and verify the latest relevant information before placing orders for TriQuint products. The information contained herein or any use of such information does not grant, explicitly or implicitly, to any party any patent rights, licenses, or any other intellectual property rights, whether with regard to such information itself or anything described by such information.

TriQuint products are not warranted or authorized for use as critical components in medical, life-saving, or life-sustaining applications, or other applications where a failure would reasonably be expected to cause severe personal injury or death.