

Product Summary

$V_{(BR)DSS}$	$R_{DS(ON)}$ max	I_D max $T_A = 25^\circ C$
-20V	150m Ω @ $V_{GS} = -4.5V$	-1.5A
	200m Ω @ $V_{GS} = -2.5V$	-1A
	240m Ω @ $V_{GS} = -1.8V$	-0.9A

Description and Applications

This MOSFET is designed to minimize the on-state resistance ($R_{DS(on)}$) and yet maintain superior switching performance, making it ideal for high efficiency power management applications.

- Backlighting
- Power Management Functions
- DC-DC Converters

Features

- Low On-Resistance
- Very Low Gate Threshold Voltage $V_{GS(th)} \leq 1V$
- Low Input Capacitance
- Fast Switching Speed
- Low Input/Output Leakage
- **Totally Lead-Free & Fully RoHS Compliant (Notes 1 & 2)**
- **Halogen and Antimony Free. "Green" Device (Note 3)**
- **Qualified to AEC-Q101 Standards for High Reliability**
- **PPAP Capable (Note 4)**

Mechanical Data

- Case: SOT-323
- Case Material: Molded Plastic, "Green" Molding Compound. UL Flammability Classification Rating 94V-0
- Moisture Sensitivity: Level 1 per J-STD-020
- Terminals Connections: See Diagram Below
- Terminals: Finish — Matte Tin Annealed over Alloy 42 Leadframe. Solderable per MIL-STD-202, Method 208 (e3)
- Weight: 0.006 grams (Approximate)

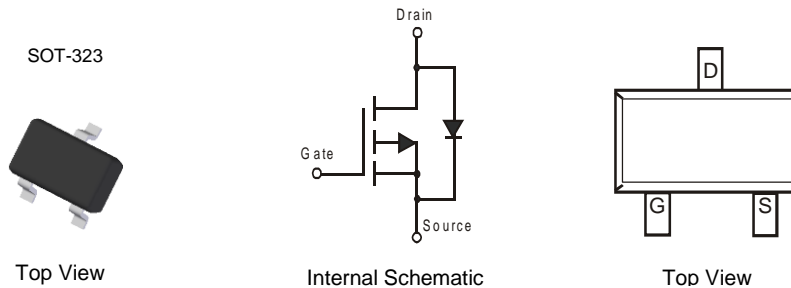

Ordering Information (Note 5)

Part Number	Case	Packaging
DMP2240UWQ-7	SOT-323	3,000/Tape & Reel

- Notes:
1. No purposely added lead. Fully EU Directive 2002/95/EC (RoHS) & 2011/65/EU (RoHS 2) compliant.
 2. See http://www.diodes.com/quality/lead_free.html for more information about Diodes Incorporated's definitions of Halogen- and Antimony-free, "Green" and Lead-free.
 3. Halogen- and Antimony-free "Green" products are defined as those which contain <900ppm bromine, <900ppm chlorine (<1500ppm total Br + Cl) and <1000ppm antimony compounds.
 4. Automotive products are AEC-Q101 qualified and are PPAP capable. Automotive, AEC-Q101 and standard products are electrically and thermally the same, except where specified. For more information, please refer to http://www.diodes.com/quality/product_grade_definitions/.
 5. For packaging details, go to our website at <http://www.diodes.com/products/packages.html>.

Marking Information

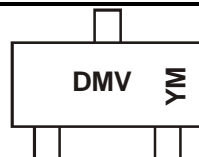

DMV = Product Type Marking Code
 YM = Date Code Marking
 Y = Year (ex: B = 2014)
 M = Month (ex: 9 = September)

Date Code Key

Year	2014	2015	2016	2017	2018	2019	2020	2021
Code	B	C	D	E	F	G	H	I

Month	Jan	Feb	Mar	Apr	May	Jun	Jul	Aug	Sep	Oct	Nov	Dec
Code	1	2	3	4	5	6	7	8	9	O	N	D

Maximum Ratings (@ $T_A = +25^\circ\text{C}$ unless otherwise specified.)

Characteristic	Symbol	Value	Units
Drain-Source Voltage	V_{DSS}	-20	V
Gate-Source Voltage	V_{GSS}	± 12	V
Drain Current (Note 6)	I_D	$T_A = +25^\circ\text{C}$	-1.5
		$T_A = +70^\circ\text{C}$	-1.0
Pulsed Drain Current	I_{DM}	-5	A

Thermal Characteristics

Characteristic	Symbol	Value	Units
Total Power Dissipation (Note 6)	P_D	250	mW
Thermal Resistance, Junction to Ambient	$R_{\theta JA}$	500	$^\circ\text{C/W}$
Operating and Storage Temperature Range	T_J, T_{STG}	-55 to +150	$^\circ\text{C}$

Electrical Characteristics (@ $T_A = +25^\circ\text{C}$ unless otherwise specified.)

Characteristic	Symbol	Min	Typ	Max	Unit	Test Condition
OFF CHARACTERISTICS (Note 7)						
Drain-Source Breakdown Voltage	BV_{DSS}	-20	—	—	V	$V_{GS} = 0V, I_D = -250\mu\text{A}$
Zero Gate Voltage Drain Current	I_{DSS}	—	—	-1.0	μA	$V_{DS} = -20V, V_{GS} = 0V$
				-5.0		
Gate-Source Leakage	I_{GSS}	—	—	± 100	nA	$V_{GS} = \pm 12V, V_{DS} = 0V$
ON CHARACTERISTICS (Note 7)						
Gate Threshold Voltage	$V_{GS(th)}$	-0.45	—	-1.0	V	$V_{DS} = V_{GS}, I_D = -250\mu\text{A}$
Static Drain-Source On-Resistance	$R_{DS(on)}$	—	92	150	m Ω	$V_{GS} = -4.5V, I_D = -2.0A$
			134	200		$V_{GS} = -2.5V, I_D = -1.5A$
			180	240		$V_{GS} = -1.8V, I_D = -0.5A$
Forward Transconductance	g_{FS}	—	3.1	—	S	$V_{DS} = -10V, I_D = -810\text{mA}$
Diode Forward Voltage (Note 7)	V_{SD}	—	—	-0.9	V	$V_{GS} = 0V, I_S = -0.5A$
DYNAMIC CHARACTERISTICS						
Input Capacitance	C_{iss}	—	320	—	pF	$V_{DS} = -16V, V_{GS} = 0V$ $f = 1.0\text{MHz}$
Output Capacitance	C_{oss}	—	80	—	pF	
Reverse Transfer Capacitance	C_{rss}	—	60	—	pF	
Turn-On Delay Time	$t_{D(on)}$	—	12.5	—	ns	$V_{DS} = -10V, V_{GS} = -4.5V,$ $R_L = 10\Omega, R_G = 1.0\Omega$
Turn-On Rise Time	t_r	—	10.3	—	ns	
Turn-Off Delay Time	$t_{D(off)}$	—	46.5	—	ns	
Turn-Off Fall Time	t_f	—	22.2	—	ns	

Notes: 6. Device mounted on FR-4 substrate PC board, 2oz. Copper, with minimum recommended pad layout.
7. Short duration pulse test used to minimize self-heating effect.

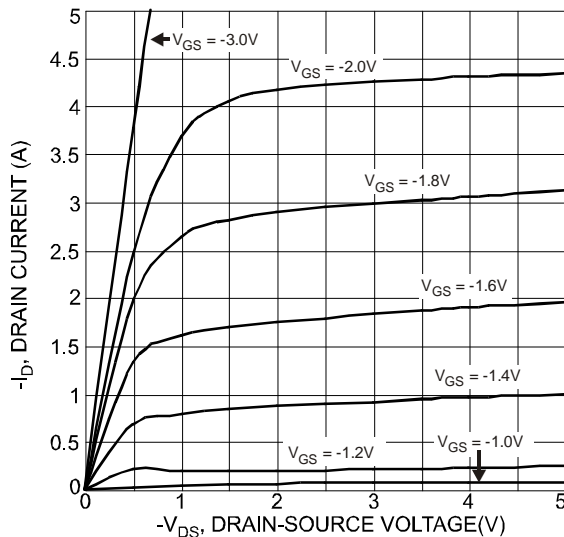

Fig. 1 Typical Output Characteristics

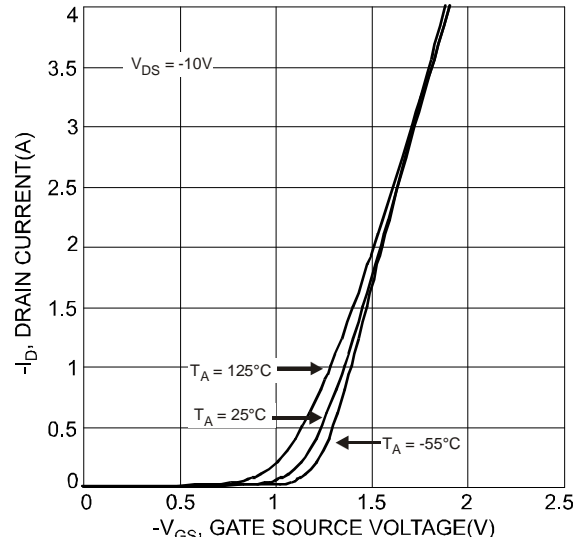

Fig. 2 Typical Transfer Characteristics

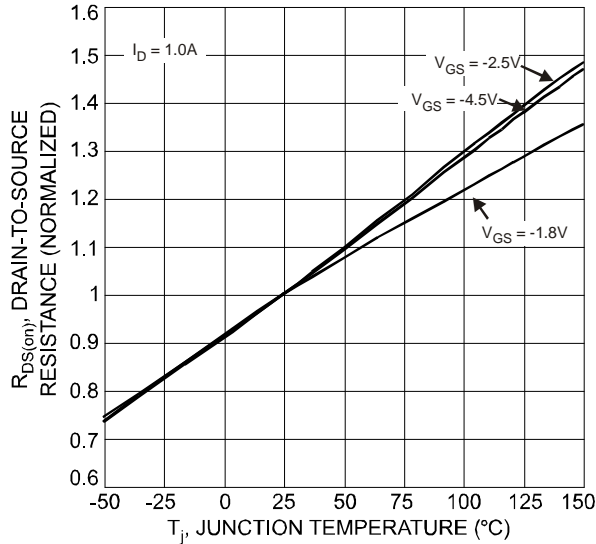

Fig. 3 On-Resistance Variation with Temperature

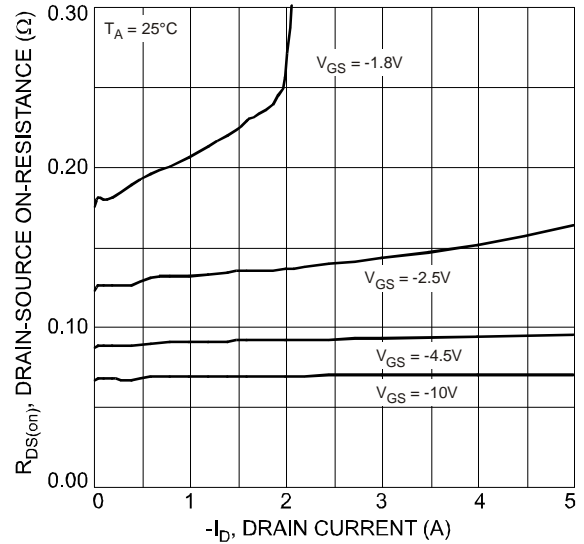

Fig. 4 On-Resistance vs Drain Current and Gate Voltage

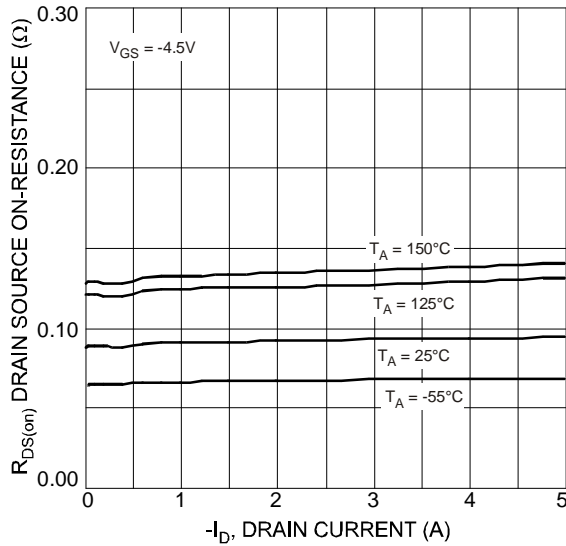

Fig. 5 Drain-Source On-Resistance Vs. Drain Current and Temperature

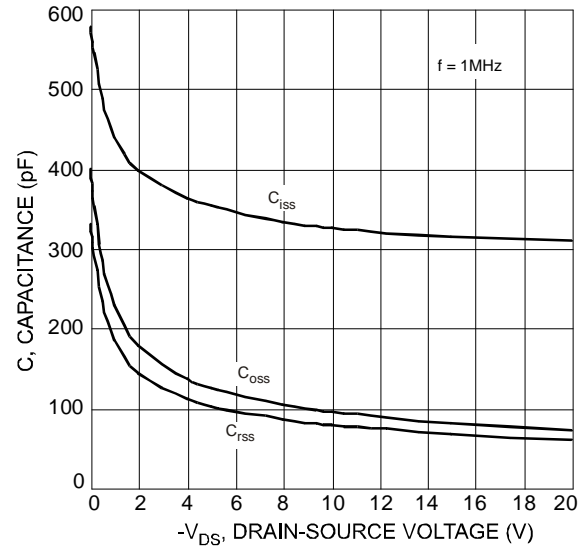

Fig. 6: Typical Capacitance

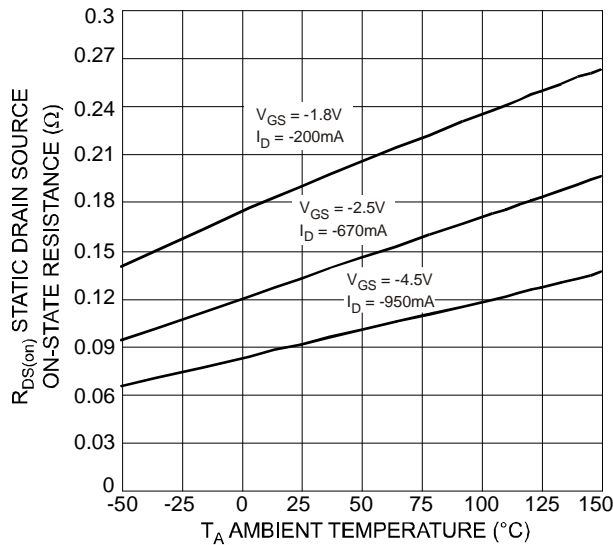

Fig. 7 Static Drain-Source On-State Resistance vs Ambient Temperature

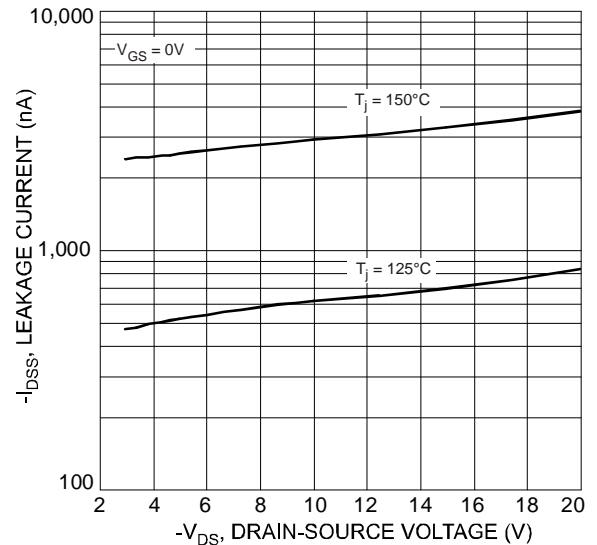

Fig. 8 Drain-Source Leakage Current vs Voltage

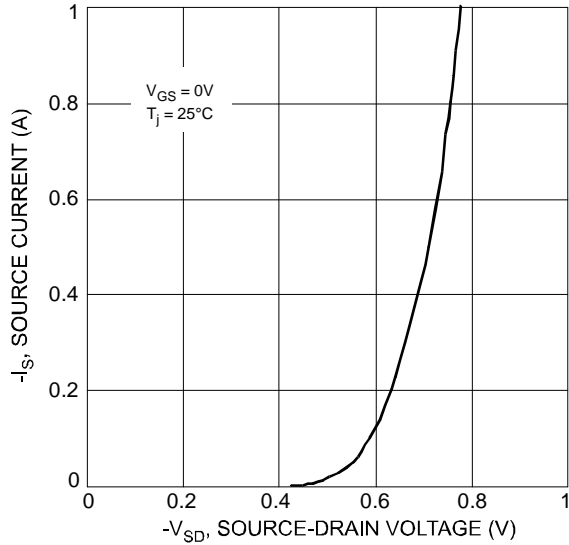
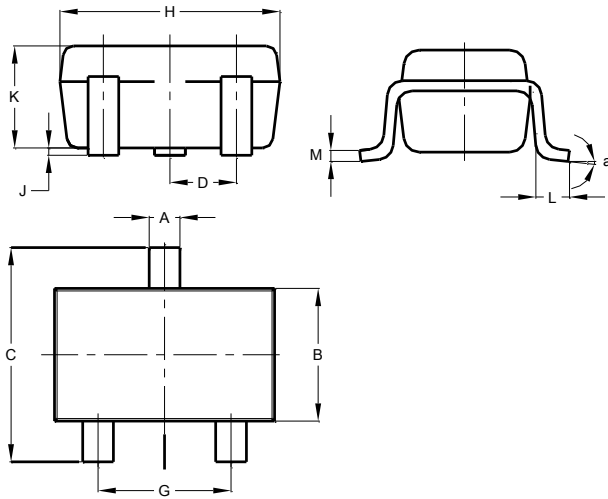

Fig. 9 Diode Forward Voltage vs. Current

Package Outline Dimensions

Please see AP02002 at <http://www.diodes.com/datasheets/ap02002.pdf> for the latest version.



SOT323			
Dim	Min	Max	Typ
A	0.25	0.40	0.30
B	1.15	1.35	1.30
C	2.00	2.20	2.10
D	0.650 BSC		
F	0.375	0.475	0.425
G	1.20	1.40	1.30
H	1.80	2.20	2.15
J	0.00	0.10	0.05
K	0.90	1.00	0.95
L	0.25	0.40	0.30
M	0.10	0.18	0.11
a	8°C		
All Dimensions in mm			

Suggested Pad Layout

Please see AP02001 at <http://www.diodes.com/datasheets/ap02001.pdf> for the latest version.

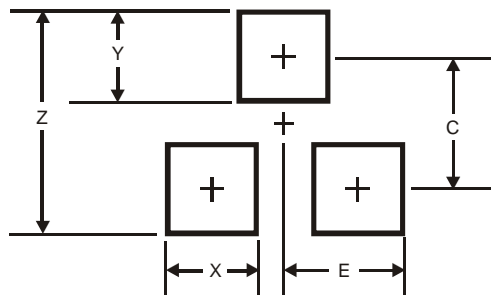

Dimensions	Value (in mm)
Z	2.8
X	0.7
Y	0.9
C	1.9
E	1.0

IMPORTANT NOTICE

DIODES INCORPORATED MAKES NO WARRANTY OF ANY KIND, EXPRESS OR IMPLIED, WITH REGARDS TO THIS DOCUMENT, INCLUDING, BUT NOT LIMITED TO, THE IMPLIED WARRANTIES OF MERCHANTABILITY AND FITNESS FOR A PARTICULAR PURPOSE (AND THEIR EQUIVALENTS UNDER THE LAWS OF ANY JURISDICTION).

Diodes Incorporated and its subsidiaries reserve the right to make modifications, enhancements, improvements, corrections or other changes without further notice to this document and any product described herein. Diodes Incorporated does not assume any liability arising out of the application or use of this document or any product described herein; neither does Diodes Incorporated convey any license under its patent or trademark rights, nor the rights of others. Any Customer or user of this document or products described herein in such applications shall assume all risks of such use and will agree to hold Diodes Incorporated and all the companies whose products are represented on Diodes Incorporated website, harmless against all damages.

Diodes Incorporated does not warrant or accept any liability whatsoever in respect of any products purchased through unauthorized sales channel. Should Customers purchase or use Diodes Incorporated products for any unintended or unauthorized application, Customers shall indemnify and hold Diodes Incorporated and its representatives harmless against all claims, damages, expenses, and attorney fees arising out of, directly or indirectly, any claim of personal injury or death associated with such unintended or unauthorized application.

Products described herein may be covered by one or more United States, international or foreign patents pending. Product names and markings noted herein may also be covered by one or more United States, international or foreign trademarks.

This document is written in English but may be translated into multiple languages for reference. Only the English version of this document is the final and determinative format released by Diodes Incorporated.

LIFE SUPPORT

Diodes Incorporated products are specifically not authorized for use as critical components in life support devices or systems without the express written approval of the Chief Executive Officer of Diodes Incorporated. As used herein:

A. Life support devices or systems are devices or systems which:

1. are intended to implant into the body, or
2. support or sustain life and whose failure to perform when properly used in accordance with instructions for use provided in the labeling can be reasonably expected to result in significant injury to the user.

B. A critical component is any component in a life support device or system whose failure to perform can be reasonably expected to cause the failure of the life support device or to affect its safety or effectiveness.

Customers represent that they have all necessary expertise in the safety and regulatory ramifications of their life support devices or systems, and acknowledge and agree that they are solely responsible for all legal, regulatory and safety-related requirements concerning their products and any use of Diodes Incorporated products in such safety-critical, life support devices or systems, notwithstanding any devices- or systems-related information or support that may be provided by Diodes Incorporated. Further, Customers must fully indemnify Diodes Incorporated and its representatives against any damages arising out of the use of Diodes Incorporated products in such safety-critical, life support devices or systems.

Copyright © 2014, Diodes Incorporated

www.diodes.com