



CEP6086L/CEB6086L

N-Channel Enhancement Mode Field Effect Transistor

PRELIMINARY

FEATURES

- 60V, 72A, $R_{DS(ON)} = 10m\Omega$ @ $V_{GS} = 10V$.
 $R_{DS(ON)} = 13.5m\Omega$ @ $V_{GS} = 4.5V$.
- Super high dense cell design for extremely low $R_{DS(ON)}$.
- High power and current handling capability.
- Lead-free plating ; RoHS compliant.
- TO-220 & TO-263 package.

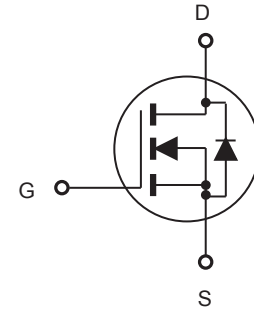

ABSOLUTE MAXIMUM RATINGS $T_C = 25^\circ C$ unless otherwise notedz

Parameter	Symbol	Limit	Units
Drain-Source Voltage	V_{DS}	60	V
Gate-Source Voltage	V_{GS}	± 20	V
Drain Current-Continuous @ $T_C = 25^\circ C$ @ $T_C = 100^\circ C$	I_D	72	A
		51	A
Drain Current-Pulsed ^a	I_{DM}	288	A
Maximum Power Dissipation @ $T_C = 25^\circ C$ - Derate above $25^\circ C$	P_D	75	W
		0.5	W/ $^\circ C$
Single Pulsed Avalanche Energy ^d	E_{AS}	132	mJ
Single Pulsed Avalanche Current ^d	I_{AS}	23	A
Operating and Store Temperature Range	T_J, T_{stg}	-55 to 175	$^\circ C$

Thermal Characteristics

Parameter	Symbol	Limit	Units
Thermal Resistance, Junction-to-Case	$R_{\theta JC}$	2	$^\circ C/W$
Thermal Resistance, Junction-to-Ambient	$R_{\theta JA}$	62.5	$^\circ C/W$

This is preliminary information on a new product in development now .
 Details are subject to change without notice .

Rev 2. 2012.Jan
<http://www.cetsemi.com>



CEP6086L/CEB6086L

Electrical Characteristics $T_C = 25^\circ\text{C}$ unless otherwise noted

Parameter	Symbol	Test Condition	Min	Typ	Max	Units
Off Characteristics						
Drain-Source Breakdown Voltage	BV_{DSS}	$V_{GS} = 0V, I_D = 250\mu A$	60			V
Zero Gate Voltage Drain Current	I_{DSS}	$V_{DS} = 60V, V_{GS} = 0V$			1	μA
Gate Body Leakage Current, Forward	I_{GSSF}	$V_{GS} = 20V, V_{DS} = 0V$			100	nA
Gate Body Leakage Current, Reverse	I_{GSSR}	$V_{GS} = -20V, V_{DS} = 0V$			-100	nA
On Characteristics^b						
Gate Threshold Voltage	$V_{GS(th)}$	$V_{GS} = V_{DS}, I_D = 250\mu A$	1		3	V
Static Drain-Source On-Resistance	$R_{DS(on)}$	$V_{GS} = 10V, I_D = 20A$		8	10	$m\Omega$
		$V_{GS} = 4.5V, I_D = 10A$		10	13.5	$m\Omega$
Dynamic Characteristics^c						
Input Capacitance	C_{iss}	$V_{DS} = 25V, V_{GS} = 0V, f = 1.0\text{ MHz}$		2815		pF
Output Capacitance	C_{oss}			235		pF
Reverse Transfer Capacitance	C_{rss}			165		pF
Switching Characteristics^c						
Turn-On Delay Time	$t_{d(on)}$	$V_{DD} = 30V, I_D = 20A, V_{GS} = 10V, R_{GEN} = 4.7\Omega$		19	38	ns
Turn-On Rise Time	t_r			10	20	ns
Turn-Off Delay Time	$t_{d(off)}$			75	150	ns
Turn-Off Fall Time	t_f			12	24	ns
Total Gate Charge	Q_g	$V_{DS} = 48V, I_D = 20A, V_{GS} = 4.5V$		32	42	nC
Gate-Source Charge	Q_{gs}			7		nC
Gate-Drain Charge	Q_{gd}			18		nC
Drain-Source Diode Characteristics and Maximum Ratings						
Drain-Source Diode Forward Current	I_S				62.5	A
Drain-Source Diode Forward Voltage ^b	V_{SD}	$V_{GS} = 0V, I_S = 20A$			1.2	V
Notes : □ a.Repetitive Rating : Pulse width limited by maximum junction temperature.□ b.Pulse Test : Pulse Width $\leq 300\mu s$, Duty Cycle $\leq 2\%$.□ c.Guaranteed by design, not subject to production testing.□ d.L = 0.5mH, $I_{AS} = 23A$, $V_{DD} = 24V$, $R_G = 25\Omega$, Starting $T_J = 25\text{ C}$						



CEP6086L/CEB6086L

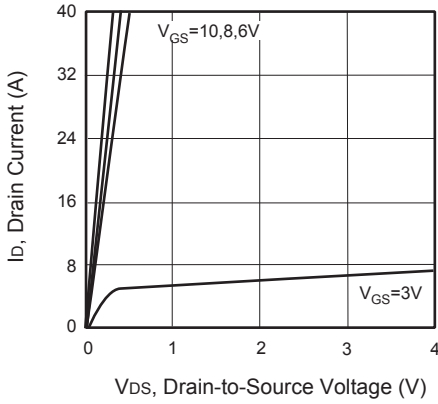

Figure 1. Output Characteristics

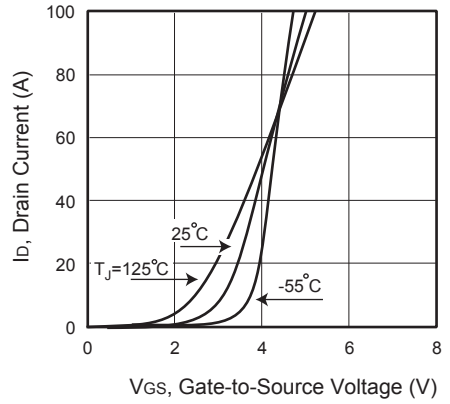

Figure 2. Transfer Characteristics

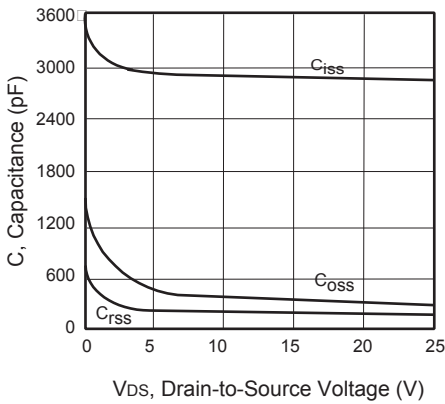

Figure 3. Capacitance

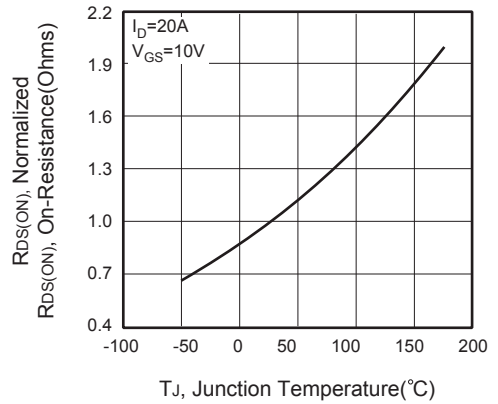

Figure 4. On-Resistance Variation with Temperature

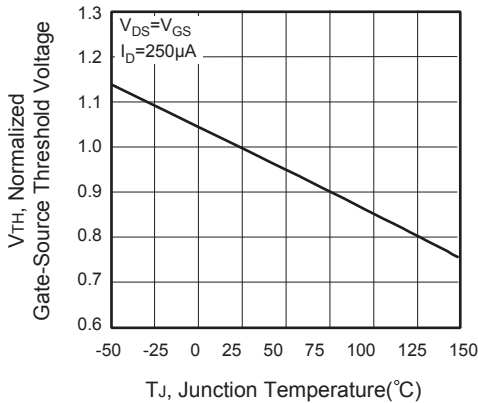

Figure 5. Gate Threshold Variation with Temperature

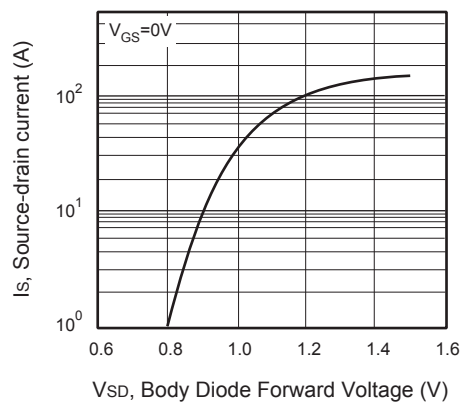

Figure 6. Body Diode Forward Voltage Variation with Source Current



CEP6086L/CEB6086L

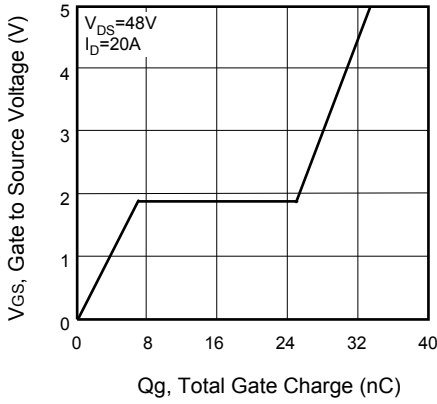

Figure 7. Gate Charge

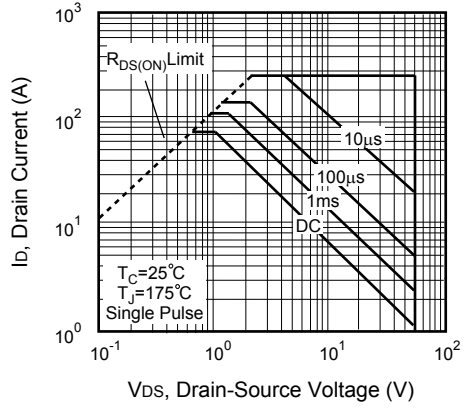

Figure 8. Maximum Safe Operating Area

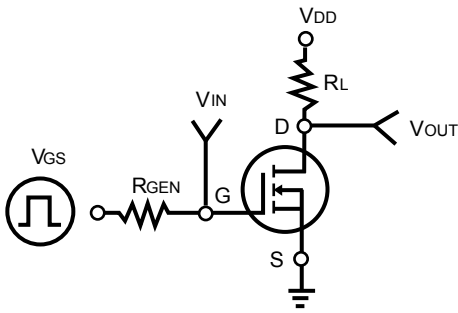

Figure 9. Switching Test Circuit

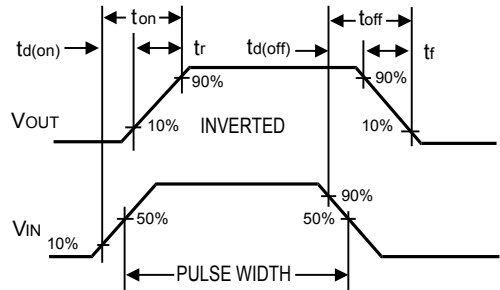

Figure 10. Switching Waveforms

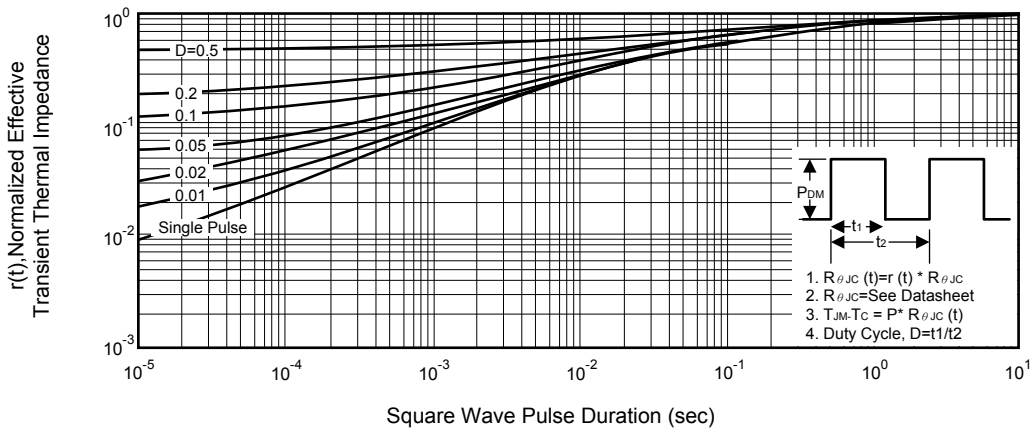

Figure 11. Normalized Thermal Transient Impedance Curve