

# 2M Series



## SMALLER, LIGHTER-WEIGHT ALTERNATIVE FOR D3899 PERFORMANCE

Amphenol 2M micro-miniature connectors are a small, light-weight option for mil-spec performance that can withstand harsh environments. They are quick-mating and a variety of styles and options are available. For full product details, please see our specifications below.

- Intermateable with Glenair® Mighty Mouse

### APPLICATIONS

- Headsets
- Tactical equipment
- Airframes
- Avionics boxes
- Handheld equipment



	2M801	2M803	2M804	2M805
Type	Dual-Start ACME Thread	Bayonet	Push-Pull	Tri-Start ACME Thread
# of Contacts	1 to 130	1 to 55	1 to 55	1 to 130
Coupling Type	Threaded Coupling 1-1/2 turns to fully mate	1/4 Turn Lock Bayonet	Push-Pull Quick-Disconnect	Tri-Start Thread Ratched
Sealing	MIL-STD-810 Method 512 1 Meter for 1 Hour	Splashproof	MIL-STD-810 Method 512 1 Meter for 1 Hour	MIL-STD-810 Method 512 1 Meter for 1 Hour
EMI-Shielding	Good	Fair	Very Good	Excellent
Mating Cycles	2000 Cycles	250 Cycles Aluminum; 500 Cycles Stainless Steel	2000 Cycles	500 Cycles
Electrical Performance	Size 12: 23A, 1800 VAC Size 16: 13A, 1800 VAC Size 20: 7.5A, 750 VAC Size 23: 5A, 500 VAC	Size 12: 23A, 1800 VAC Size 16: 13A, 1800 VAC Size 20: 7.5A, 750 VAC Size 23: 5A, 500 VAC	Size 12: 23A, 1800 VAC Size 16: 13A, 1800 VAC Size 20: 7.5A, 750 VAC Size 23: 5A, 500 VAC	Size 12: 23A, 1800 VAC Size 16: 13A, 1800 VAC Size 20: 7.5A, 750 VAC Size 23: 5A, 500 VAC
Shock & Vibration	37 g's Random Vibration; 300 g's Shock	37 g's Random Vibration; 300 g's Shock	37 g's Random Vibration; 300 g's Shock	37 g's Random Vibration; 300 g's Shock

**MATERIALS AND FINISHES**

Shell	Aluminum alloy 6061 T6, stainless steel passivated, 200C
Insert	Polyphenylene sulfide (PPS)
Contact Retention Clip	Beryllium copper, heat-treated, unplated
Contacts	50u" gold-plated copper alloy
Socket Contact Hood	Passivated stainless steel
Grommet & Seals	Fluorosilicone rubber
Adhesives	Epoxy film
Potting Compound for PCB & Solder Versions	High-strength epoxy

**ELECTRICAL DATA**

Contact Sizes 23, 20, 20HD, 16, & 12 AWG

Operating Voltage & Test Voltage (Mated Condition)

CONTACT SIZE	23	20	20HD	16	12
Sea Level VAC	500	1800	750	1800	1800
40,000 Feet VAC	100	325	150	1000	1000

Current Rating (Max)

CONTACT SIZE	AMPERES
23	5
20	7.5
16	13
12	23

Contact Resistance

CONTACT SIZE	MILLIVOLT DROP
23	73 @ 5A test current
20	55 @ 7.5A test current
16	49 @ 13A test current
12	42 @ 23A test current

Insulation Resistance 5,000 megaohms minimum

**MECHANICAL**

Operating Temperature	-67 F to +302 F (-55C to +150 C) aluminium -67 F to +392 F (-55C to +200 C) stainless steel
Sealing	1 meter for 1 hour (2M803 splashproof)

Insulation Strip Length

CONTACT SIZE	STRIP LENGTH
23	0.150 (3.81)
20	0.188 (2.54)
20HD	0.150 (3.81)
16	0.188 (2.54)
12	0.188 (2.54)

Mating Life	2000 cycles; 2M803 aluminum 250 cycles
Salt Spray	Plating C & M: 48-hours Plating MT, NF, ZN, ZNU, UCR: 500-hours
Fungus	Fungus inert
Vibration	37g
Gunfire Vibration	No discontinuity greater than 1 microseconds; no cracking, breaking or loosening of parts, plug shall not disengage from receptacle. Connectors meet electrical requirements after vibration test.
Shock	300 G, half-sine, 3ms, 3 axes
EMI-Shielding Effectiveness	55 dB min from 100 MHz to 1000 MHz
Contact Type	Crimp, solder or printed circuit
Number of Contacts	1 to 130

Contact Retention

CONTACT SIZE	MIN. POUNDS	MIN. NEWTONS
23	6	27
20	15	67
20HD	9	40
16	25	111
12	25	111

Contact Separation Force

CONTACT SIZE	MIN. OUNCES	MIN. NEWTONS
23	0.5	0.14
20	0.7	0.19
20HD	0.7	0.19
16	2.0	0.56
12	3.0	0.83

Coupling Torque

SHELL SIZE	INCH / POUNDS
5, 6, 7	8
8, 9	9
10	12
12, 13	16
14, 15	28
16, 17	24
21	32

Polarization	Dual-Start ACME Thread coupling, 3 keyways with optional keyway rotations, note insert remained fixed.
--------------	--

LAYOUTS BY NUMBER OF CONTACTS

Front face of pin inserts shown. (Sockets mirror image)

CONTACTS	1		2		
2M801	6-1	7-1	8-2	10-2	13-2
2M803	6-1	7-1	8-2	10-2	12-2
2M804	6-1	7-1	8-2	10-2	12-2
2M805	8-1	9-1	10-2	12-2	15-2
# OF CONTACTS & SIZE	1#16	1#12	2#16	2#12	2#12
DWV VOLTAGE (VAC)	1800	1800	1800	1800	1800

CONTACTS	3			4	
2M801	5-3	6-23	13-3	6-4	9-4
2M803	5-3	6-23	12-3	6-4	9-4
2M804	5-3	6-23	12-3	6-4	9-4
2M805	NA	8-23	15-3	8-4	11-4
# OF CONTACTS & SIZE	3#23	3#20HD	3#12	4#23	4#16
DWV VOLTAGE (VAC)	500	750	1800	500	1800

CONTACTS	5			6	
2M801	7-25	10-5	16-5	6-6	8-200
2M803	7-25	10-5	14-5	6-6	8-200
2M804	7-25	10-5	14-5	6-6	8-200
2M805	9-25	12-5	18-5	8-6	10-200
# OF CONTACTS & SIZE	5#20HD	5#16	5#12	6#23	4#23, 2#20
DWV VOLTAGE (VAC)	750	1800	1800	500	1000 (#20), 500 (#23)

CONTACTS	6 (CONT.)		7		
2M801	9-200	10-201	6-7	13-7	17-7
2M803	9-200	10-201	6-7	12-7	NA
2M804	9-200	10-201	6-7	12-7	NA
2M805	11-200	12-201	8-7	15-7	19-7
# OF CONTACTS & SIZE	4#23, 2#16	4#23, 2#12	7#23	7#16	7#12
DWV VOLTAGE (VAC)	1800 (#16), 500 (#23)	1800 (#12), 500 (#23)	500	1800	1800

CONTACTS	8			10		
2M801	8-28	13-200	7-10	9-201	9-210	10-202
2M803	8-28	12-200	7-10	9-201	9-210	10-202
2M804	8-28	12-200	7-10	9-201	9-210	10-202
2M805	10-28	15-200	9-10	11-201	11-210	12-202
# OF CONTACTS & SIZE	8#20HD	6#23, 2#12	10#23	8#23, 12#20	10#20HD	8#23, 2#16
DWV VOLTAGE (VAC)	750	1800 (#12), 500 (#23)	500	1000 (#700), 500 (#23)	750	1800 (#16), 500 (#23)



# LAYOUTS BY NUMBER OF CONTACTS

Front face of pin inserts shown. (Sockets mirror image)

CONTACTS	12			13	
2M801	16-12	21-12	13-201	8-13	10-200
2M803	14-12	NA	12-201	8-13	10-200
2M804	14-12	NA	12-201	8-13	10-200
2M805	18-12	23-12	15-201	10-13	12-200
# OF CONTACTS & SIZE	12#16	12#12	10#23, 2#12	13#23	12#23, 1#12
DWV VOLTAGE (VAC)	1800	1800	1800(#12), 500(#23)	500	1800(#12), 500(#23)

CONTACTS	14	19	20	22	26
2M801	17-14	9-19	13-220	21-22	10-26
2M803	NA	9-19	12-220	NA	10-26
2M804	NA	9-19	12-220	NA	10-26
2M805	19-14	11-19	15-220	23-22	12-26
# OF CONTACTS & SIZE	14#16	19#23	20#20HD	22#16	26#23
DWV VOLTAGE (VAC)	1800	500	750	1800	500

CONTACTS	35	37	41	55	69
2M801	16-235	13-37	17-241	16-55	21-269
2M803	14-235	12-37	NA	14-55	NA
2M804	14-235	12-37	NA	14-55	NA
2M805	18-235	15-37	19-241	18-55	23-269
# OF CONTACTS & SIZE	35#20HD	37#23	41#20HD	55#23	69#20HD
DWV VOLTAGE (VAC)	750	500	750	500	750

CONTACTS	85	130
2M801	17-85	21-130
2M803	NA	NA
2M804	15-85	NA
2M805	19-85	23-130
# OF CONTACTS & SIZE	85#23	130#23
DWV VOLTAGE (VAC)	500	500

1	2	3	5	6
2M801-007-16	NF	8-13	P	A
SHELL STYLE	PLATING	SHELL SIZE - LAYOUT	CONTACT TYPE	KEYING

### STEP 1: SELECT SHELL STYLE, PLUG OR RECEPTACLE

RECEPTACLES

Mates with

PLUGS

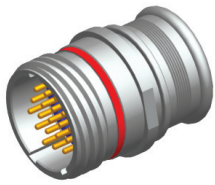

**2M801-009-01**  
In-Line with Integral  
Backshell

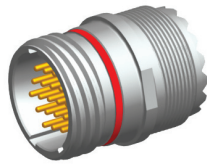

**2M801-010-01**  
In-Line with Rear Accessory  
Threads



**2M801-007-16**  
Plug with Integral Backshell  
Anti-Decoupling Spring

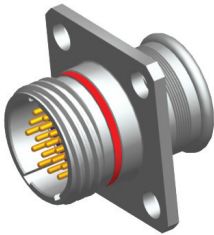

**2M801-009-02**  
Square Flange with  
Integral Backshell

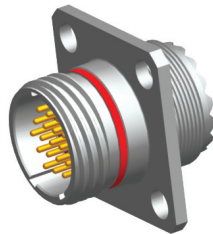

**2M801-010-02**  
Square Flange with  
Rear Accessory Threads

**2M801-007-26**  
Self-Locking Plug with  
Ratchet Mechanism

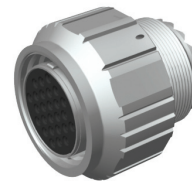

**2M801-008-16**  
Plug with Rear Accessory Thread  
Anti-Decoupling Spring

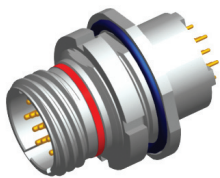

**2M801-009-07**  
Jam Nut with  
Integral Backshell

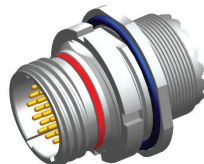

**2M801-010-07**  
Jam Nut with  
Rear Accessory Threads

**2M801-008-26**  
Self-Locking Plug with  
Ratchet Mechanism

### STEP 2: SELECT CLASS

- C** = Aluminum/ Black Anodize (Non-Conductive) (RoHS)
- M** = Aluminum/ Electroless Nickel (RoHS)
- NF** = Aluminum/ Cadmium with Olive Drab Chromate
- MT** = Aluminum/ Nickel-PTFE (Duralon) (RoHS)
- Z1** = Stainless Steel/ Passivated
- ZN** = Aluminum/ Zinc-Nickel with Olive Drab Chromate
- ZNU** = Aluminum/ Zinc-Nickel with Black Chromate (RoHS)

### STEP 3: SELECT LAYOUT

CONTACT SIZE						
LAYOUT	# OF CONTACTS	23	20	20HD	16	12
5-3	3	3				
6-1	1				1	
6-4	4	4				
6-6	6	6				
6-7	7	7				
6-23	3			3		
7-1	1					1
7-10	10	10				
7-25	5			5		
8-2	2				2	
8-13	13	13				
8-28	8			8		
8-200	6	4	2			
9-4	4				4	
9-19	19	19				
9-200	6	4			2	
9-201	10	8	2			
9-210	10			10		
10-2	2					2
10-5	5				5	
10-26	26	26				
10-200	13	12				1
10-201	6	4				2
10-202	10	8			2	
13-2	2					2
13-3	3					3
13-7	7				7	
13-37	37	37				
13-200	8	6				2
13-201	12	10				2
13-220	20			20		
16-5	5					5
16-12	12				12	
16-55	55	55				
16-235	35			35		
17-7	7					7
17-14	14				14	
17-85	85	85				
17-241	41			41		
21-12	12					12
21-22	22				22	
21-130	130	130				
21-269	69			69		

### STEP 4: SELECT CONTACT

P = Pin    S = Socket

### STEP 5: SELECT KEYING

	A KEYWAY DEGREE	B KEYWAY DEGREE
A	150	210
B	75	210
C	95	230
D	140	275
E	75	275
F	95	210

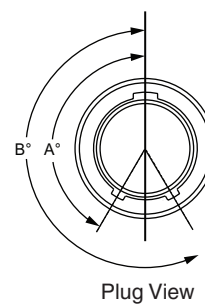
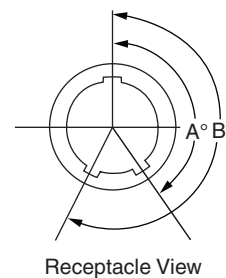

<b>1</b>	<b>2</b>	<b>3</b>	<b>5</b>	<b>6</b>
<b>2M803-001-06</b>	<b>NF</b>	<b>8-13</b>	<b>P</b>	<b>N</b>
SHELL STYLE	PLATING	SHELL SIZE - LAYOUT	CONTACT TYPE	KEYING

**STEP 1: SELECT SHELL STYLE, PLUG OR RECEPTACLE**

**RECEPTACLES**

Mates with

**PLUGS**

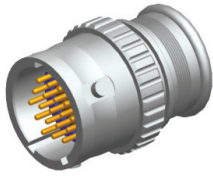

**2M803-003-01**  
In-Line with Integral Backshell

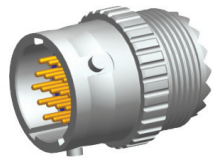

**2M803-004-01**  
In-Line with Rear Accessory Threads



**2M803-001-06**  
Plug with Integral Backshell

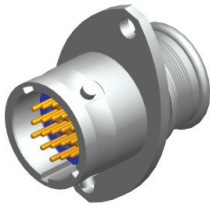

**2M803-003-02**  
2-Hole Flange with Integral Backshell

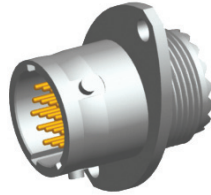

**2M803-004-02**  
2-Hole Flange with Rear Accessory Threads

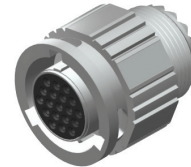

**2M803-002-06**  
Plug with Rear Accessory Thread

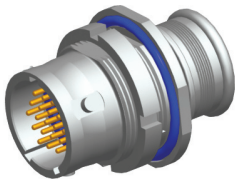

**2M803-003-07**  
Jam Nut with Integral Backshell

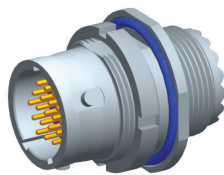

**2M803-004-07**  
Jam Nut with Rear Accessory Threads

**STEP 2: SELECT CLASS**

- C** = Aluminum/ Black Anodize (Non-Conductive) (RoHS)
- M** = Aluminum/ Electroless Nickel (RoHS)
- NF** = Aluminum/ Cadmium with Olive Drab Chromate
- MT** = Aluminum/ Nickel-PTFE (Dumalon) (RoHS)
- Z1** = Stainless Steel/ Passivated
- ZN** = Aluminum/ Zinc-Nickel with Olive Drab Chromate
- ZNU** = Aluminum/ Zinc-Nickel with Black Chromate (RoHS)

### STEP 3: SELECT LAYOUT

LAYOUT	# OF CONTACTS	CONTACT SIZE				
		23	20	20HD	16	12
5-3	3	3				
6-1	1				1	
6-4	4	4				
6-6	6	6				
6-7	7	7				
6-23	3			3		
7-1	1					1
7-10	10	10				
7-25	5			5		
8-2	2				2	
8-13	13	13				
8-28	8			8		
8-200	6	4	2			
9-4	4				4	
9-19	19	19				
9-200	6	4			2	
9-201	10	8	2			
9-210	10			10		
10-2	2					2
10-5	5				5	
10-26	26	26				
10-200	13	12				1
10-201	6	4				2
10-202	10	8			2	
12-2	2					2
12-3	3					3
12-7	7				7	
12-37	37	37				
12-200	8	6				2
12-201	12	10				2
12-220	20			20		
14-5	5					5
14-12	12				12	
14-55	55	55				
14-235	35			35		

### STEP 4: SELECT CONTACT

**P** = Pin      **S** = Socket

### STEP 5: SELECT KEYING

	A KEYWAY DEGREE	B KEYWAY DEGREE
N	150	210
X	75	210
Y	95	230
Z	140	275

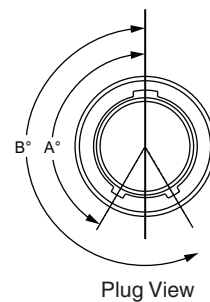
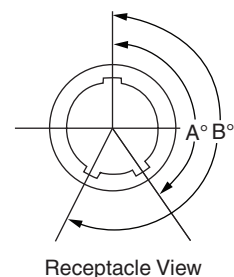

CREATE YOUR PART NUMBER 2M804 PUSH-PULL QUICK DISCONNECT

<b>1</b>	<b>2</b>	<b>3</b>	<b>5</b>	<b>6</b>
<b>2M804-001-06</b>	<b>NF</b>	<b>8-13</b>	<b>P</b>	<b>A</b>
SHELL STYLE	PLATING	SHELL SIZE - LAYOUT	CONTACT TYPE	KEYING

**STEP 1: SELECT SHELL STYLE, PLUG OR RECEPTACLE**

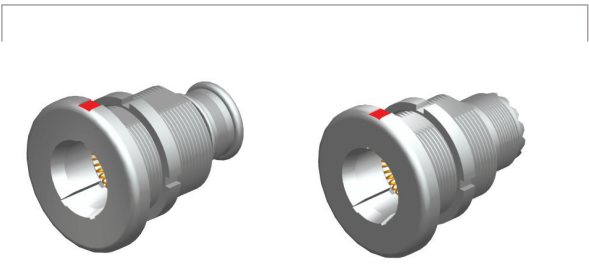

**2M804-003-00**  
Front Mount Jam Nut with Integral Backshell

**2M804-004-00**  
Front Mount Jam Nut with Rear Accessory Threads



**2M804-001-06**  
Plug with Integral Backshell

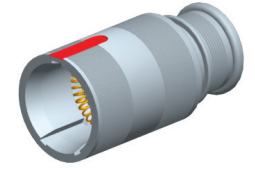

**2M804-003-01**  
In-Line with Integral Backshell

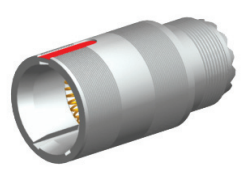

**2M804-004-01**  
In-Line with Rear Accessory Threads



**2M804-002-06**  
Plug with Rear Accessory Thread

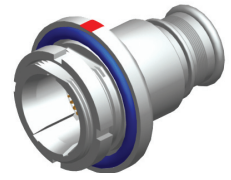

**2M804-003-07**  
Rear Mount Jam Nut with Integral Backshell

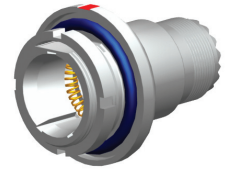

**2M804-004-07**  
Rear Mount Jam Nut with Rear Accessory Threads

**STEP 2: SELECT CLASS**

- C** = Aluminum/ Black Anodize (Non-Conductive) (RoHS)
- M** = Aluminum/ Electroless Nickel (RoHS)
- NF** = Aluminum/ Cadmium with Olive Drab Chromate
- MT** = Aluminum/ Nickel-PTFE (Duralon) (RoHS)
- Z1** = Stainless Steel/ Passivated
- ZN** = Aluminum/ Zinc-Nickel with Olive Drab Chromate
- ZNU** = Aluminum/ Zinc-Nickel with Black Chromate (RoHS)

### STEP 3: SELECT LAYOUT

LAYOUT	# OF CONTACTS	CONTACT SIZE				
		23	20	20HD	16	12
5-3	3	3				
6-1	1				1	
6-4	4	4				
6-6	6	6				
6-7	7	7				
6-23	3			3		
7-1	1					1
7-10	10	10				
7-25	5			5		
8-2	2				2	
8-13	13	13				
8-28	8			8		
8-200	6	4	2			
9-4	4				4	
9-19	19	19				
9-200	6	4			2	
9-201	10	8	2			
9-210	10			10		
10-2	2					2
10-5	5				5	
10-26	26	26				
10-200	13	12				1
10-201	6	4				2
10-202	10	8			2	
12-2	2					2
12-3	3					3
12-7	7				7	
12-37	37	37				
12-200	8	6				2
12-201	12	10				2
12-220	20			20		
14-5	5					5
14-12	12				12	
14-55	55	55				
14-235	35			35		

### STEP 4: SELECT CONTACT

P = Pin    S = Socket

### STEP 5: SELECT KEYING

	A KEYWAY DEGREE	B KEYWAY DEGREE
OMIT FOR NORMAL	SINGLE MASTER KEYWAY	
A	150	210
B	75	210
C	95	230
D	140	275

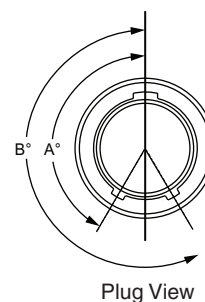
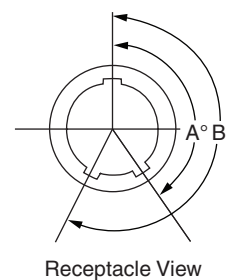

## CREATE YOUR PART NUMBER 2M805 TRI-START THREADED COUPLING

1	2	3	5	6
<b>2M805-001-16</b>	<b>NF</b>	<b>8-23</b>	<b>P</b>	<b>A</b>
SHELL STYLE	PLATING	SHELL SIZE - LAYOUT	CONTACT TYPE	KEYING

**STEP 1: SELECT SHELL STYLE, PLUG OR RECEPTACLE**

RECEPTACLES

Mates with

PLUGS

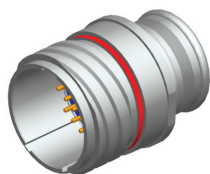
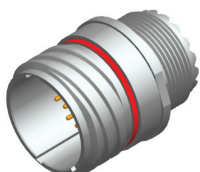
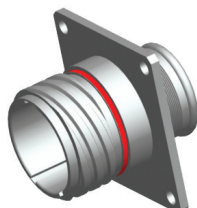
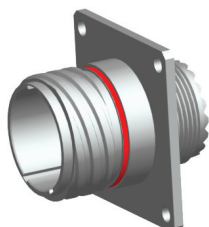
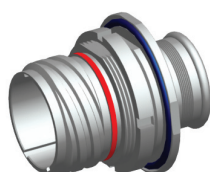
**2M805-003-01**In-Line with  
Integral Backshell**2M805-004-01**In-Line with  
Rear Accessory Threads**2M805-001-16**Plug with Integral Backshell  
Anti-Decoupling Spring**2M805-003-02**Square Flange with  
Integral Backshell**2M805-004-02**Square Flange with  
Rear Accessory Threads**2M805-002-16**Plug with Rear Accessory Thread  
Anti-Decoupling Spring**2M805-003-07**Jam Nut with  
Integral Backshell**2M805-004-07**Jam Nut with  
Rear Accessory Threads**STEP 2: SELECT CLASS**

- C** = Aluminum/ Black Anodize  
(Non-Conductive) (RoHS)
- M** = Aluminum/ Electroless Nickel (RoHS)
- NF** = Aluminum/ Cadmium with Olive Drab Chromate
- MT** = Aluminum/ Nickel-PTFE  
(Duralon) (RoHS)
- Z1** = Stainless Steel/ Passivated
- ZN** = Aluminum/ Zinc-Nickel with Olive Drab Chromate
- ZNU** = Aluminum/ Zinc-Nickel with Black Chromate (RoHS)



### STEP 3: SELECT LAYOUT

LAYOUT	# OF CONTACTS	CONTACT SIZE				
		23	20	20HD	16	12
8-1	1				1	
8-4	4	4				
8-6	6	6				
8-7	7	7				
8-23	3			3		
9-1	1					1
9-10	10	10				
9-25	5			5		
10-2	2				2	
10-13	13	13				
10-28	8			8		
10-200	6	4	2			
11-4	4				4	
11-19	19	19				
11-200	6	4			2	
11-201	10	8	2			
11-210	10			10		
12-2	2					2
12-5	5				5	
12-26	26	26				
12-200	13	12				1
12-201	6	4				2
12-202	10	8			2	
15-2	2					2
15-3	3					3
15-7	7				7	
15-37	37	37				
15-200	8	6				2
15-201	12	10				2
15-220	20			20		
18-5	5					5
18-12	12				12	
18-55	55	55				
18-235	35			35		
19-7	7					7
19-14	14				14	
19-85	85	85				
19-241	41			41		
23-12	12					12
23-22	22				22	
23-130	130	130				
23-269	69			69		

### STEP 4: SELECT CONTACT

P = Pin    S = Socket

### STEP 5: SELECT KEYING

	A KEYWAY DEGREE	B KEYWAY DEGREE
A	150	210
B	75	210
C	95	230
D	140	275

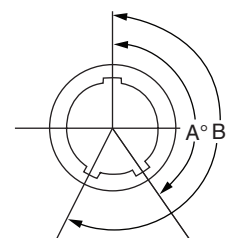

Receptacle View

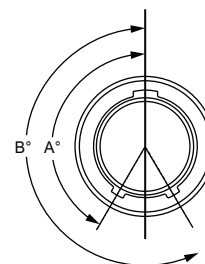

Plug View

PINS



CONTACT SIZE AWG	WIRE SIZE AWG	PIN CONTACT	COLOR BANDS			WIRE STRIP LENGTH	WIRE SEALING RANGE		WIRE HOLE FILLER	HAND-CRIMP TOOL	POSITIONER (LOCATOR)	PLASTIC INSERTION/EXTRACTION TOOL	METAL INSERTION TOOL	METAL EXTRACTION TOOL
			1	2	3		MIN.	MAX.						
23	22,24,26,& 28	2M809-001	N/A	N/A	N/A	0.15 (3.81)	0.024 (.609)	0.052 (1.32)	2M809-155 (Black)	M22520/2-01	K1461-1	2M809-088	DAK225-22	DRK225-22
	26,28, & 30	2M809-042	Blue	N/A	N/A	0.15 (3.81)	0.024 (.609)	0.052 (1.32)			2M809-057			
20HD	20,22, & 24	2M809-204	N/A	N/A	N/A	0.15 (3.81)	0.040 (1.02)	0.083 (2.11)	MS27488-20-2 (Red)	M22520/2-01	2M809-206	2M809-203	N/A	N/A
20	20,22, & 24	M39029/58-363	Orange	Blue	Orange	.188 (4.77)	0.040 (1.02)	0.083 (2.11)	MS27488-20-2 (Red)	M22520/1-01	M22520/1-04	M81969/14-10	11-008674-020	11-008675-020
16	16,18, & 20	M39029/58-364	Orange	Blue	Yellow	.188 (4.77)	0.065 (1.65)	0.109 (2.77)	MS27488-16-2 (Green)	M22520/1-01	M22520/1-04	M81969/14-03	11-008674-016	11-008675-016
12	12 & 14	M39029/58-365	Orange	Blue	Green	.188 (4.77)	0.097 (2.46)	0.142 (.361)	MS27488-12-2 (Orange)	M22520/1-01	M22520/1-04	M81969/14-04	11-008674-012	11-008675-012

SOCKETS



CONTACT SIZE AWG	WIRE SIZE AWG	PIN CONTACT	COLOR BANDS			WIRE STRIP LENGTH	WIRE SEALING RANGE		WIRE HOLE FILLER	HAND-CRIMP TOOL	POSITIONER (LOCATOR)	PLASTIC INSERTION/EXTRACTION TOOL	METAL INSERTION TOOL	METAL EXTRACTION TOOL
			1	2	3		MIN.	MAX.						
23	22,24,26,& 28	2M809-002	N/A	N/A	N/A	0.15 (3.81)	0.024 (.609)	0.052 (1.32)	2M809-155 (Black)	M22520/2-01	K1461-1	2M809-088	DAK225-22	DRK225-22
	26,28, & 30	2M809-043	Blue	N/A	N/A	0.15 (3.81)	0.024 (.609)	0.052 (1.32)			2M809-057			
20HD	20,22, & 24	2M809-205	N/A	N/A	N/A	0.15 (3.81)	0.040 (1.02)	0.083 (2.11)	MS27488-20-2 (Red)	M22520/2-01	2M809-206	2M809-203	N/A	N/A
20	20,22, & 24	M39029/57-357	Orange	Green	Violet	.188 (4.77)	0.040 (1.02)	0.083 (2.11)	MS27488-20-2 (Red)	M22520/1-01	M22520/1-04	M81969/14-10	11-008674-020	11-008675-020
16	16,18, & 20	M39029/57-358	Orange	Green	Gray	.188 (4.77)	0.065 (1.65)	0.109 (2.77)	MS27488-16-2 (Green)	M22520/1-01	M22520/1-04	M81969/14-03	11-008674-016	11-008675-016
12	12 & 14	M39029/57-359	Orange	Green	White	.188 (4.77)	0.097 (2.46)	0.142 (.361)	MS27488-12-2 (Orange)	M22520/1-01	M22520/1-04	M81969/14-04	11-008674-012	11-008675-012

All dimensions in inches

PLUG

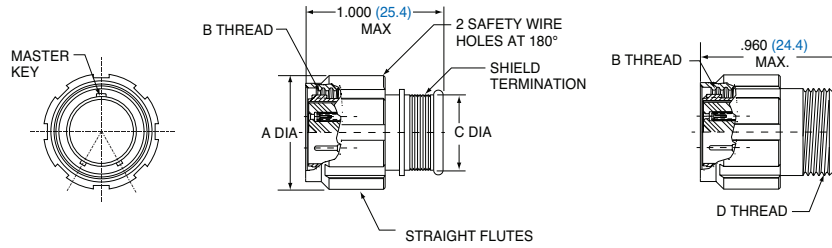

SHELL SIZE	STYLE 16		STYLE 26		B THREAD	C DIA.		D THREAD UNEF-2A
	A DIA.		A DIA.			IN.	MM.	
5	0.540	13.72	0.64	16.256	.3125-.05P-.1L-2B	0.245	6.223	.250 - 32
6	0.600	15.24	0.7	17.78	.3750-.05P-.1L-2B	0.29	7.366	.3125 - 32
7	0.680	17.27	0.78	19.812	.4375-.05P-.1L-2B	0.39	9.906	.4375 - 28
8	0.750	19.05	0.85	21.59	.5000-.05P-.1L-2B	0.445	11.303	.5000 - 28
9	0.810	20.57	0.91	23.114	.5625-.05P-.1L-2B	0.5	12.7	.5625 - 24
10	0.880	22.35	0.98	24.892	.6250-.05P-.1L-2B	0.56	14.224	.6250 - 24
13	1.050	26.67	1.15	29.21	.8125-.1P-.2L-2B	0.65	16.51	.6875 - 24
16	1.240	31.50	1.34	34.036	1.000-.1P-.2L-2B	0.805	20.447	.9375 - 20
17	1.300	33.02	1.4	35.56	1.0625-.1P-.2L-2B	0.85	21.59	.9375 - 20
21	1.550	39.37	1.65	41.91	1.3125-.1P-.2L-2B	1.11	28.194	1.1875 - 18

JAM NUT RECEPTACLE

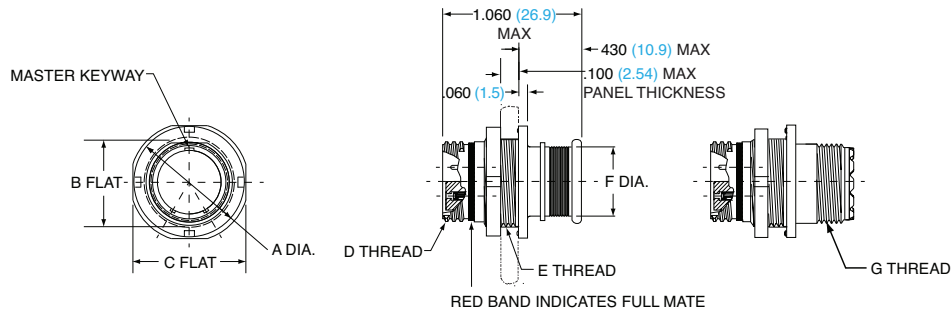

SHELL SIZE	A DIA.		B FLAT		C FLAT	D THREAD	E THREAD	F DIA.		G THREAD
	IN.	MM.	IN.	MM.				IN.	MM.	
5	0.575	14.61	0.350	8.89	0.545	.3125-.05P-.1L-2A	.3125-.05P-.1L-2A	0.245	6.22	.2500-32 UN-2A
6	0.635	16.13	0.410	10.41	0.595	.3750-.05P-.1L-2A	.3750-.05P-.1L-2A	0.290	7.37	.3125-32 UN-2A
7	0.755	19.18	0.536	13.61	0.723	.4375-.05P-.1L-2A	.4375-.05P-.1L-2A	0.390	9.91	.4375-28 UN-2A
8	0.755	19.18	0.536	13.61	0.723	.5000-.05P-.1L-2A	.5000-.05P-.1L-2A	0.445	11.30	.5000-28 UN-2A
9	0.830	21.08	0.596	15.14	0.790	.5625-.05P-.1L-2A	.5625-.05P-.1L-2A	0.500	12.70	.5625-24 UN-2A
10	0.890	22.61	0.658	16.71	0.855	.6250-.05P-.1L-2A	.6250-.05P-.1L-2A	0.560	14.22	.6250-24 UN-2A
13	1.078	27.38	0.845	21.46	1.044	.8125-.1P-.2L-2A	.8125-.1P-.2L-2A	0.650	16.51	.6875-24 UN-2A
16	1.264	32.11	1.022	25.96	1.230	1.0000-.1P-.2L-2A	1.0000-.1P-.2L-2A	0.805	20.45	.9375-20 UN-2A
17	1.325	33.66	1.096	27.84	1.290	1.0625-.1P-.2L-2A	1.0625-.1P-.2L-2A	0.850	21.59	.9375-20 UN-2A
21	1.625	41.28	1.345	34.16	1.577	1.3125-.1P-.2L-2A	1.3125-.1P-.2L-2A	1.110	28.19	1.1875-18 UN-2A

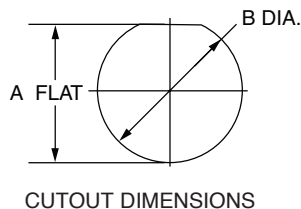

SHELL SIZE	A FLAT		B DIA.	
	IN +/- .002	MM +/- 0.05	IN +/- .002	MM +/- 0.05
5	0.356	9.04	0.385	9.78
6	0.416	10.57	0.447	11.35
7	0.542	13.77	0.572	14.53
8	0.542	13.77	0.572	14.53
9	0.602	15.29	0.635	16.13
10	0.666	16.62	0.697	17.7
13	0.851	21.62	0.885	22.48
16	1.028	26.11	1.075	27.31
17	1.102	27.99	1.135	28.83
21	1.354	34.39	1.385	35.18

All dimensions in inches (millimeters in blue)

**SQUARE FLANGED RECEPTACLE**

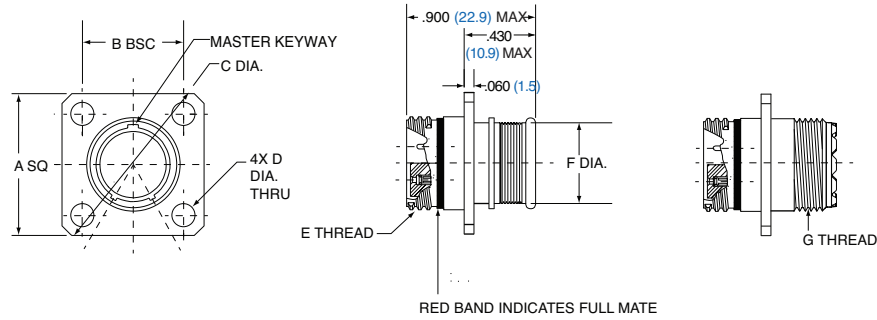

SHELL SIZE	A		B BSC		C DIA.		D DIA.		E THREAD	F DIA.		G THREAD UN-2A
	IN.	MM.	IN.	MM.	IN.	MM.	IN. ± .003	MM. ± .08		IN.	MM.	
5	0.530	13.46	0.363	9.22	0.680	17.27	0.093	2.36	.3125-.05P-.1L-2A	0.245	6.22	.2500-32
6	0.590	14.99	0.423	10.74	0.750	19.05	0.093	2.36	.3750-.05P-.1L-2A	0.290	7.37	.3125-32
7	0.650	16.51	0.483	12.27	0.850	21.59	0.093	2.36	.4375-.05P-1L-2A	0.390	9.91	.4375-28
8	0.712	18.08	0.545	13.84	0.938	23.83	0.093	2.36	.5000-.05P-1L-2A	0.445	11.30	.5000-28
9	0.850	21.59	0.607	15.42	1.125	28.58	0.128	3.25	.5625-.05P-.1L-2A	0.500	12.70	.5625-24
10	0.890	22.61	0.670	17.02	1.188	30.18	0.128	3.25	.6250-.05P-1L-2A	0.560	14.22	.6250-24
13	1.030	26.16	0.812	20.62	1.375	34.93	0.128	3.25	.8125-.1P-.2L-2A	0.650	16.51	.6875-24
16	1.219	30.96	0.981	24.92	1.625	41.28	0.128	3.25	1.0000-.1P-.2L-2A	0.805	20.45	.9375-20
17	1.280	32.51	1.060	26.92	1.700	43.18	0.128	3.25	1.0625-.1P-.2L-2A	0.850	21.59	.9375-20
21	1.430	36.32	1.205	30.61	1.938	49.23	0.128	3.25	1.3125-.1P-.2L-2A	1.110	28.19	1.1875-18

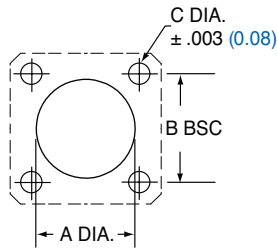

FLANGE MOUNT PANEL CUTOUT						
SHELL SIZE	A DIA.		B DIA.		C DIA.	
	IN.	MM.	IN.	MM.	IN.	MM.
5	0.330	8.38	0.363	9.22	0.093	2.36
6	0.390	9.91	0.423	10.74	0.093	2.36
7	0.450	11.43	0.483	12.27	0.093	2.36
8	0.510	12.95	0.545	13.84	0.093	2.36
9	0.575	14.61	0.607	15.42	0.128	3.25
10	0.640	16.26	0.670	17.02	0.128	3.25
13	0.825	20.96	0.812	20.65	0.128	3.25
16	1.015	25.78	0.981	24.92	0.128	3.25
17	1.075	27.31	1.060	26.92	0.128	3.25
21	1.325	33.66	1.205	30.61	0.128	3.25

**IN-LINE RECEPTACLE**

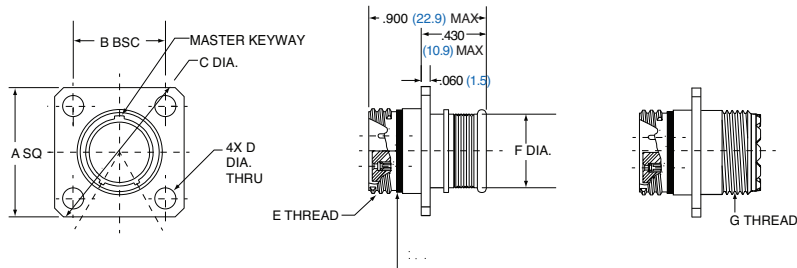

SHELL SIZE	A DIA.		B FLAT		E THREAD	D DIA.		G THREAD UNEF-2A
	IN.	MM.	IN.	MM.		IN.	MM.	
5	0.355	9.02	0.325	8.13	.3125-.05P-.1L-2A	0.245	6.22	.2500-32
6	0.415	10.54	0.385	9.78	.3750-.05P-.1L-2A	0.29	7.37	.3125-32
7	0.48	12.19	0.445	11.3	.4375-.05P-.1L-2A	0.39	9.91	.4375-28
8	0.54	13.72	0.51	12.95	.5000-.05P-.1L-2A	0.445	11.3	.5000-28
9	0.605	15.37	0.575	14.61	.5625-.05P-.1L-2A	0.5	12.7	.5625-24
10	0.665	16.89	0.635	16.13	.6250-.05P-.1L-2A	0.56	14.22	.6250-24
13	0.855	21.72	0.825	20.96	.8125-.1P-.2L-2A	0.65	16.51	.6875-24
16	1.04	26.42	1.01	25.65	1.0000-.1P-.2L-2A	0.805	20.44	.9375-20
17	1.11	28.19	1.07	27.18	1.0625-.1P-.2L-2A	0.85	21.59	.9375-20
21	1.405	35.69	1.385	35.18	1.3125-.1P-.2L-2A	1.11	28.19	1.1875-18

All dimensions in inches (millimeters in blue)

PLUG

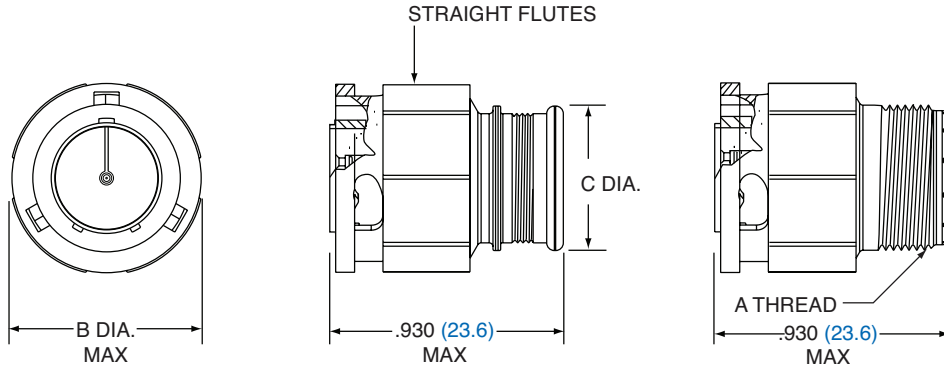

SHELL SIZE	A THREAD	B DIA. MAX.		C DIA.	
		IN.	MM.	IN.	MM.
5	.2500-32 UNEF-2A	0.470	11.94	0.210	5.33
6	.3125-32 UNEF-2A	0.535	13.59	0.280	7.11
7	.4375-28 UNEF-2A	0.615	15.62	0.390	9.91
8	.5000-28 UNEF-2A	0.670	17.02	0.455	11.56
9	.5625-24 UNEF-2A	0.740	18.80	0.510	12.95
10	.6250-24 UNEF-2A	0.805	20.45	0.570	14.48
12	.6875-24 UNEF-2A	0.890	27.60	0.650	16.51
14	.9375-20 UNEF-2A	1.095	27.81	0.805	20.45

IN-LINE

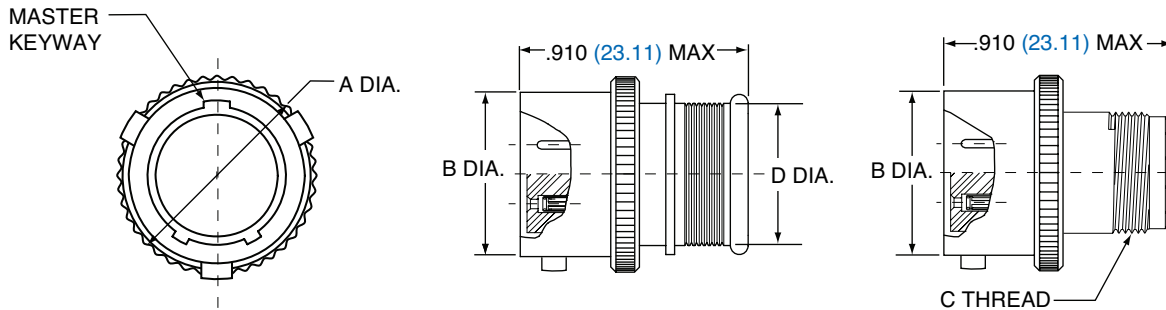

SHELL SIZE	A MAX.		B DIA.		C THREAD	D DIA.	
	IN.	MM.	IN.	MM.		IN.	MM.
5	0.380	9.65	0.300	7.62	.2500-32 UNEF-2A	0.230	5.84
6	0.465	11.81	0.362	9.19	.3125-32 UNEF-2A	0.286	7.26
7	0.500	12.70	0.436	11.07	.4375-28 UNEF-2A	0.390	9.91
8	0.570	14.48	0.508	12.90	.5000-28 UNEF-2A	0.440	11.18
9	0.652	16.56	0.561	14.25	.5625-24 UNEF-2A	0.500	12.70
10	0.715	18.15	0.635	16.13	.6250-24 UNEF-2A	0.562	14.27
12	0.805	20.45	0.714	18.14	.6875-24 UNEF-2A	0.650	16.51
14	0.915	23.24	0.865	21.97	.9375-20 UNEF-2A	0.805	20.45

All dimensions in inches (millimeters in blue)

**FLANGE MOUNT RECEPTACLE**

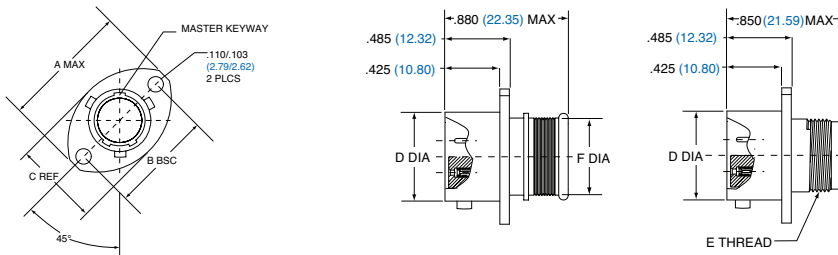

SHELL SIZE	A MAX.		B BSC.		C REF.		D DIA.		E THREAD	F DIA.	
	IN.	MM.	IN.	MM.	IN.	MM.	IN.	MM.		IN.	MM.
5	0.703	17.86	0.513	13.03	0.460	11.68	0.300	7.62	.2500-32 UNEF-2A	0.230	5.84
6	0.788	20.02	0.598	15.19	0.522	13.26	0.362	9.19	.3125-32 UNEF-2A	0.286	7.26
7	0.890	22.61	0.708	17.98	0.590	14.99	0.436	11.07	.4375-28 UNEF-2A	0.390	9.91
8	1.154	29.31	0.964	24.49	0.668	16.97	0.500	12.70	.5000-28 UNEF-2A	0.440	11.18
9	1.207	30.66	1.017	25.83	0.721	18.31	0.561	14.25	.5625-24 UNEF-2A	0.500	12.70
10	1.291	32.79	1.101	27.97	0.795	20.19	0.635	16.13	.6250-24 UNEF-2A	0.562	14.27
12	1.394	35.41	1.204	30.58	0.874	22.20	0.714	18.14	.6875-24 UNEF-2A	0.650	16.51
14	1.545	39.24	1.280	32.51	1.050	26.67	0.865	21.97	.9375-20 UNEF-2A	0.805	20.45

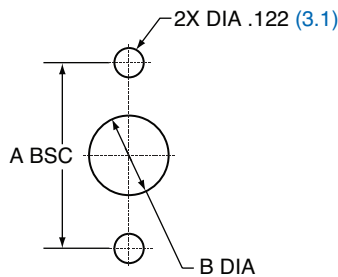

FLANGE MOUNT PANEL CUTOUTS				
SHELL SIZE	A BSC.		B DIA.	
	IN.	MM.	IN.	MM.
5	0.513	13.03	0.365	9.25
6	0.598	15.19	0.430	10.92
7	0.708	17.98	0.520	13.21
8	0.964	17.98	0.592	15.04
9	1.017	25.83	0.645	16.38
10	1.101	27.97	0.726	18.44
12	1.204	30.58	0.832	21.13
14	1.280	32.51	0.945	24.00

**JAM NUT RECEPTACLES**

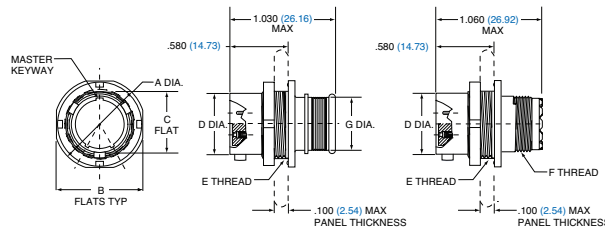

SHELL SIZE	A DIA.		B FLAT		C FLAT		D DIA.		E THREAD	F THREAD	G DIA.	
	IN.	MM.	IN.	MM.	IN.	MM.	IN.	MM.			IN.	MM.
5	0.575	14.61	0.545	13.84	0.350	8.89	0.300	7.62	.3750-32 UNEF-2A	.2500-32 UNEF-2A	0.230	5.84
6	0.635	16.13	0.595	15.11	0.410	10.41	0.362	9.19	.4375-28 UNEF-2A	.3125-32 UNEF-2A	0.286	7.26
7	0.755	19.18	0.723	18.36	0.536	13.61	0.436	11.07	.5625-32 UN-2A	.4375-28 UNEF-2A	0.390	9.91
8	0.830	21.08	0.790	20.11	0.593	15.10	0.500	12.70	.6250-28 UN-2A	.5000-28 UNEF-2A	0.440	11.18
9	0.830	21.08	0.790	20.07	0.596	15.14	0.561	14.25	.6250-28 UN-2A	.5625-24 UNEF-2A	0.500	12.70
10	0.955	24.26	0.925	23.51	0.721	18.31	0.635	16.13	.7500-28 UN-2A	.6250-24 UNEF-2A	0.562	14.27
12	1.078	27.38	1.044	26.52	0.845	21.46	0.714	18.14	.8750-28 UN-2A	.6875-24 UNEF-2A	0.650	16.51
14	1.264	32.11	1.230	31.24	1.022	25.96	0.865	21.97	1.0625-20 UN-2A	.9375-20 UNEF-2A	0.805	20.45

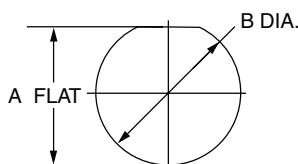

JAM NUT PANEL CUTOUTS				
SHELL SIZE	A FLAT		B DIA.	
	IN.	MM.	IN.	MM.
5	0.355	9.02	0.382	9.70
6	0.415	10.54	0.445	11.30
7	0.541	13.74	0.572	14.53
8	.603/.599	15.32/15.21	0.635	16.13
9	0.601	15.27	0.643	16.33
10	.731/.727	18.57/18.47	0.76	18.29
12	0.850	21.59	0.885	22.48
14	1.031	23.19	1.072	27.23

All dimensions in inches (millimeters in blue)

PLUG

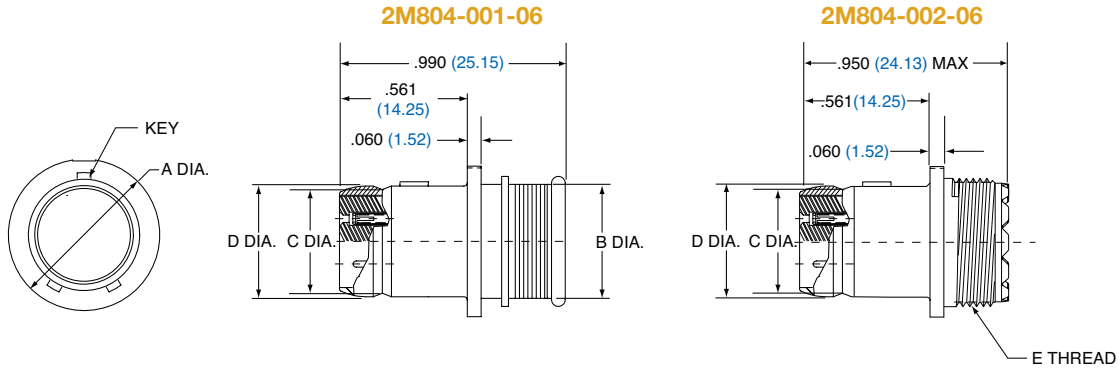

SHELL SIZE	A DIA.		B DIA.		C DIA.		D DIA.		E THREAD
	IN.	MM.	IN.	MM.	IN.	MM.	IN.	MM.	
5	0.420	10.67	0.246	6.25	0.219	5.56	0.260	6.60	.2500-32 UNEF-2A
6	0.495	12.57	0.286	7.26	0.275	6.99	0.325	8.26	.3125-32 UNEF-2A
7	0.562	14.28	0.390	9.91	0.351	8.92	0.390	9.90	.4375-28 UNEF-2A
8	0.605	15.37	0.442	11.23	0.398	10.11	0.440	11.18	.5000-28 UNEF-2A
9	0.670	17.02	0.500	12.70	0.450	11.43	0.495	12.57	.5625-24 UNEF-2A
10	0.745	18.92	0.564	14.33	0.529	13.44	0.563	14.30	.6250-24 UNEF-2A
12	0.852	21.64	0.650	16.51	0.646	16.41	0.685	17.40	.6875-24 UNEF-2A
14	0.985	25.02	0.805	20.45	0.761	19.33	0.810	20.57	.9375-20 UNEF-2A

IN-LINE RECEPTACLE

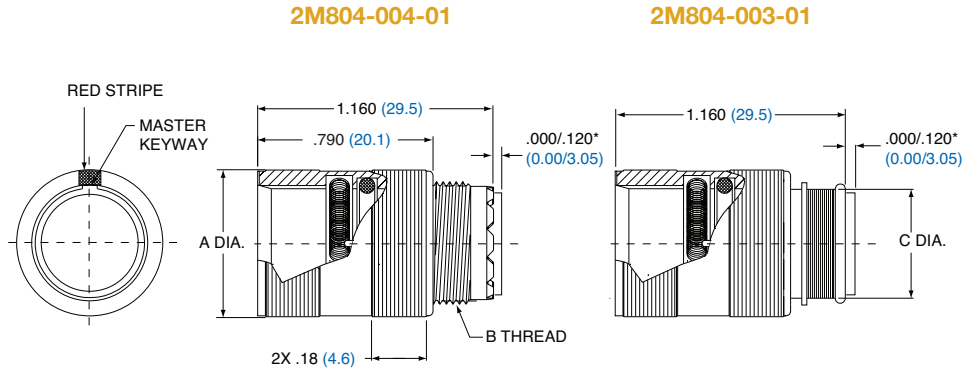

SHELL SIZE	A DIA.		B THREAD	C DIA.	
	IN.	MM.		IN.	MM.
5	0.450	11.43	.2500-32 UNEF-2A	0.246	6.25
6	0.520	13.21	.3125-32 UNEF-2A	0.286	7.26
7	0.580	14.73	.4375-28 UNEF-2A	0.390	9.91
8	0.603	15.32	.5000-28 UNEF-2A	0.442	11.23
9	0.695	17.65	.5625-24 UNEF-2A	0.500	12.70
10	0.735	18.67	.6250-24 UNEF-2A	0.564	14.33
12	0.880	22.35	.6875-24 UNEF-2A	0.650	16.51
14	1.010	25.65	.9375-20 UNEF-2A	0.805	20.45

All dimensions in inches (millimeters in blue)

REAR MOUNT JAM NUT

2M804-004-07  
2M804-003-07

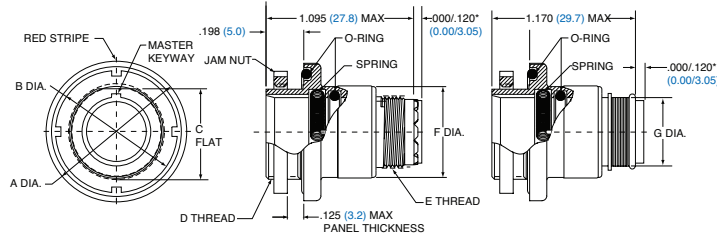

SHELL SIZE	A DIA.		B DIA.		C FLAT		D THREAD	E THREAD	F DIA.		G DIA.	
	IN.	MM.	IN.	MM.	IN.	MM.			IN.	MM.	IN.	MM.
5	0.775	19.69	0.562	14.27	0.415	10.54	.4375-32 UN-2A	.2500-32 UNEF-2A	0.450	11.43	0.235	5.97
6	0.830	21.08	0.625	15.87	0.467	14.40	.5000-32 UN-2A	.3125-32 UNEF-2A	0.520	13.21	0.286	7.26
7	0.910	23.11	0.750	19.05	0.594	15.09	.6250-28 UN-2A	.4375-28 UNEF-2A	0.580	14.73	0.390	9.91
8	0.955	24.26	0.750	19.05	0.594	15.09	.6250-28 UN-2A	.5000-28 UNEF-2A	0.603	15.32	0.442	11.23
9	1.000	25.40	0.812	20.62	0.655	16.64	.6875-28 UN-2A	.5625-24 UNEF-2A	0.695	17.65	0.500	12.70
10	1.085	27.48	0.875	22.22	0.721	18.31	.7500-28 UN-2A	.6250-24 UNEF-2A	0.735	18.67	0.564	14.33
12	1.180	29.97	1.000	25.40	0.843	21.41	.8750-28 UN-2A	.6875-24 UNEF-2A	0.880	22.35	0.650	16.51
14	1.370	34.80	1.125	28.57	0.968	24.59	1.0000-28 UN-2A	.9375-20 UNEF-2A	1.010	25.65	0.805	20.45

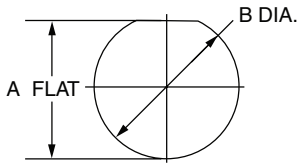

REAR MOUNT JAM NUT PANEL CUTOUT				
SHELL SIZE	A FLAT		B DIA.	
	IN. ±.002	MM. ± 0.05	IN. ±.005	MM. ± 0.13
5	0.423	10.74	0.448	11.38
6	0.475	12.07	0.510	12.95
7	0.602	15.29	0.635	16.13
8	0.602	15.29	0.635	16.13
9	0.663	16.84	0.698	17.73
10	0.729	18.82	0.760	19.30
12	0.851	21.62	0.885	22.48
14	0.976	24.79	1.010	25.65

FRONT MOUNT JAM NUT

2M804-004-00  
2M804-003-00

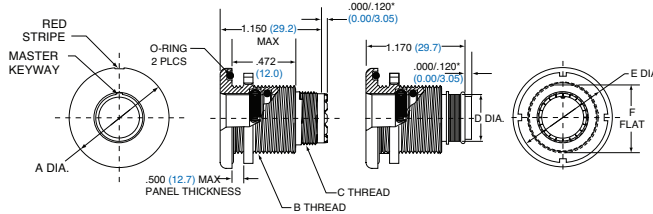

SHELL SIZE	A DIA.		B THREAD	C THREAD	D DIA.		E DIA.		F FLAT.	
	IN.	MM.			IN.	MM.	IN.	MM.		
5	0.830	21.08	.5000-32 UN-2A	.2500-32 UNEF-2A	0.246	6.25	0.625	15.87	0.470	11.94
6	0.885	22.48	.5625-32 UN-2A	.3125-32 UNEF-2A	0.286	7.26	0.688	17.47	0.530	13.46
7	0.955	25.27	.6875-28 UN-2A	.4375-28 UNEF-2A	0.390	9.91	0.812	20.62	0.663	16.84
8	0.955	25.27	.6875-28 UN-2A	.5000-28 UNEF-2A	0.442	11.23	0.812	20.62	0.663	16.84
9	1.075	27.31	.7500-28 UN-2A	.5625-24 UNEF-2A	0.500	12.70	0.875	22.22	0.720	18.29
10	1.140	28.95	.8125-28 UN-2A	.6250-24 UNEF-2A	0.564	14.33	0.938	23.82	0.780	19.81
12	1.340	34.04	1.0000-28 UN-2A	.6875-24 UNEF-2A	0.650	16.51	1.125	28.57	0.970	24.64
14	1.390	35.31	1.0625-20 UN-2A	.9375-20 UNEF-2A	0.805	20.45	1.188	30.18	1.020	25.91

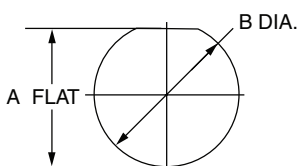

FRONT MOUNT JAM NUT PANEL CUTOUT				
SHELL SIZE	A FLAT		B DIA.	
	IN. ±.002	MM. ± 0.05	IN. ±.005	MM. ± 0.13
5	0.477	12.12	0.510	12.95
6	0.537	13.64	0.573	14.55
7	0.670	17.02	0.698	17.73
8	0.670	17.02	0.698	17.73
9	0.727	18.47	0.760	19.30
10	0.787	20.19	0.823	20.90
12	0.977	24.82	1.010	25.65
14	1.027	26.09	1.073	27.25

All dimensions in inches (millimeters in blue)



PLUG

2M805-001

2M805-002

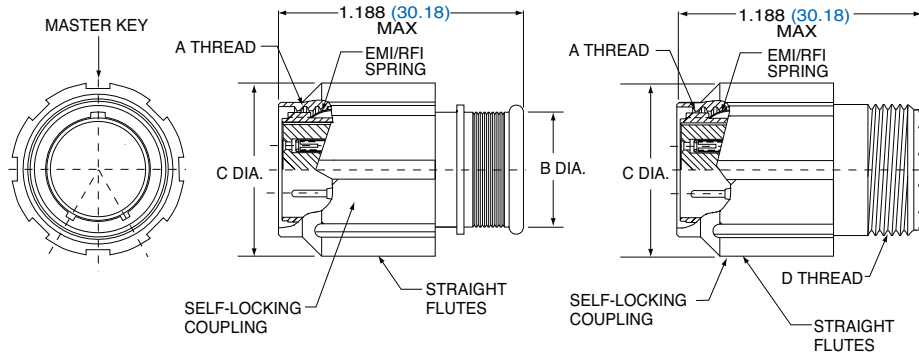

SHELL SIZE	A THREADS	B DIA.		C DIA.		D THREADS ACCESSORY
		IN.	MM.	IN.	MM.	
8	.5000.1P-.3L-TS-2B	0.317	8.05	0.691	17.55	.3750-32 UNEF-2A
9	.5625.1P-.3L-TS-2B	0.397	10.08	0.787	19.99	.4375-28 UNEF-2A
10	.6250.1P-.3L-TS-2B	0.473	12.01	0.826	20.98	.5000-28 UNEF-2A
11	.6875.1P-.3L-TS-2B	0.519	13.18	0.916	23.27	.5625-24 UNEF-2A
12	.7500.1P-.3L-TS-2B	0.585	14.86	0.982	24.94	.6250-24 UNEF-2A
15	.9375.1P-.3L-TS-2B	0.687	17.45	1.097	27.86	.7500-20 UNEF-2A
18	1.1250.1P-.3L-TS-2B	0.884	22.45	1.29	32.77	.9375-20 UNEF-2A
19	1.1875.1P-.3L-TS-2B	0.884	22.45	1.31	33.27	.9375-20 UNEF-2A
23	1.4375.1P-.3L-TS-2B	1.135	28.83	1.562	39.67	1.1875-18 UNEF-2A

IN-LINE RECEPTACLE

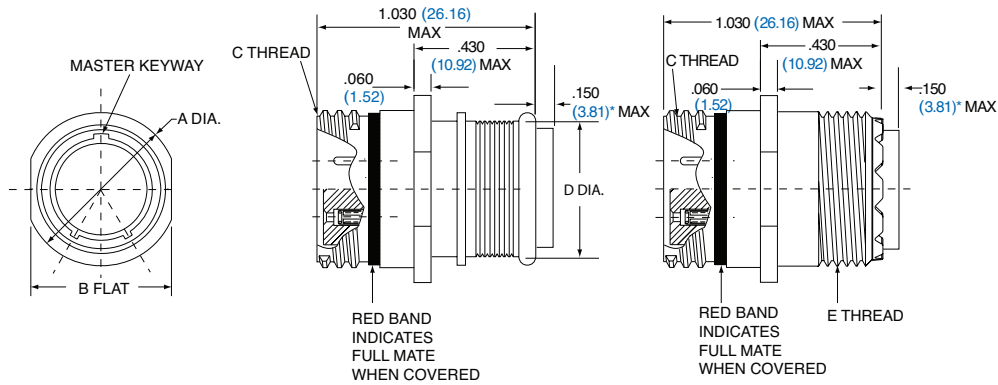

SHELL SIZE	A DIA.		B FLAT		C THREADS	D DIA.		E THREADS ACCESSORY
	IN.	MM.	IN.	MM.		IN.	MM.	
8	0.540	13.72	0.510	12.95	.5000.1P-.3L-TS-2A	0.316	8.05	.3750-32 UNEF-2A
9	0.605	15.37	0.575	14.61	.5625.1P-.3L-TS-2A	0.397	10.08	.4375-28 UNEF-2A
10	0.668	16.96	0.638	16.21	.6250.1P-.3L-TS-2A	0.472	12.01	.5000-28 UNEF-2A
11	0.730	18.54	0.700	17.78	.6875.1P-.3L-TS-2A	0.519	13.18	.5625-24 UNEF-2A
12	0.793	20.14	0.763	19.38	.7500.1P-.3L-TS-2A	0.585	14.86	.6250-24 UNEF-2A
15	0.980	24.89	0.950	24.13	.9375.1P-.3L-TS-2A	0.687	17.45	.7500-20 UNEF-2A
18	1.165	29.59	1.135	28.83	1.1250.1P-.3L-TS-2A	0.884	22.45	.9375-20 UNEF-2A
19	1.235	31.37	1.205	30.61	1.1875.1P-.3L-TS-2A	0.884	22.45	.9375-20 UNEF-2A
23	1.485	37.72	1.455	39.96	1.4375.1P-.3L-TS-2A	1.134	28.80	1.1875-18 UNEF-2A

All dimensions in inches (millimeters in blue)

**SQUARE FLANGED RECEPTACLE**

2M805-003-02  
2M805-004-02

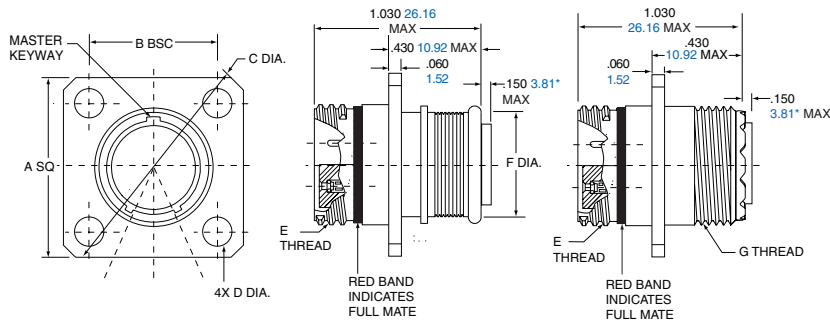

SHELL SIZE	A SQ.		B BSC.		C DIA.		D DIA.		E THREADS	F DIA.		G THREADS ACCESSORY
	IN.	MM.	IN.	MM.	IN.	MM.	IN. ±.003	MM. ±.08		IN.	MM.	
8	0.850	21.59	0.660	16.76	1.150	29.21	0.094	2.39	.5000.1P-.3L-TS-2A	0.316	8.05	.3750-32 UNEF-2A
9	0.913	23.19	0.723	18.36	1.230	31.24	0.094	2.39	.5625.1P-.3L-TS-2A	0.397	10.08	.4375-28 UNEF-2A
10	0.975	24.77	0.785	19.94	1.330	33.78	0.094	2.39	.6250.1P-.3L-TS-2A	0.472	12.01	.5000-28 UNEF-2A
11	1.039	26.39	0.848	21.54	1.410	35.81	0.094	2.39	.6875.1P-.3L-TS-2A	0.519	13.18	.5625-24 UNEF-2A
12	1.099	27.91	0.909	23.09	1.500	38.10	0.094	2.39	.7500.1P-.3L-TS-2A	0.585	14.86	.6250-24 UNEF-2A
15	1.288	32.74	1.058	26.87	1.750	44.45	0.128	3.25	.9375.1P-.3L-TS-2A	0.687	17.45	.7500-20 UNEF-2A
18	1.475	37.47	1.255	31.88	2.000	50.80	0.128	3.25	1.1250.1P-.3L-TS-2A	0.884	22.45	.9375-20 UNEF-2A
19	1.537	71.06	1.327	33.71	2.094	53.19	0.128	3.25	1.1875.1P-.3L-TS-2A	0.884	22.45	.9375-20 UNEF-2A
23	1.787	45.39	1.570	39.88	2.440	61.98	0.128	3.25	1.4375.1P-.3L-TS-2A	1.134	28.80	1.1875-18 UNEF-2A

**JAM NUT RECEPTACLE**

2M805-003-07  
2M805-004-07

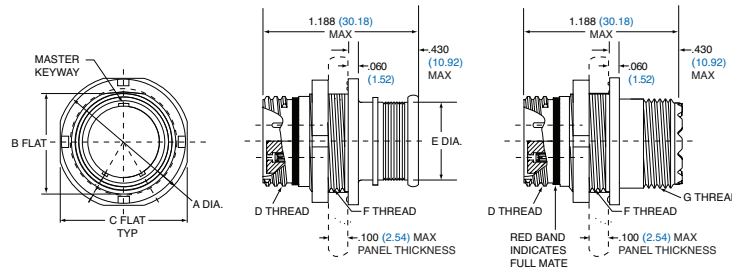

SHELL SIZE	A DIA.		B FLAT		C FLAT		D THREADS	E DIA.		F THREADS	G ACCESSORY THREADS
	IN.	MM.	IN.	MM.	IN.	MM.		IN.	MM.		
8	0.760	19.30	0.535	13.59	0.730	18.54	.5000.1P-.3L-TS-2A	0.317	8.05	.5625-28 UNEF-2A	.3750-32 UNEF-2A
9	0.880	22.35	0.661	16.79	0.850	21.59	.5625.1P-.3L-TS-2A	0.397	10.08	.6875-28 UN-2A	.4375-28 UNEF-2A
10	0.880	22.35	0.661	16.79	0.850	21.59	.6250.1P-.3L-TS-2A	0.473	12.01	.6875-28 UN-2A	.5000-28 UNEF-2A
11	0.955	24.26	0.721	18.31	0.925	23.50	.6875.1P-.3L-TS-2A	0.519	13.18	.7500-28 UN-2A	.5625-24 UNEF-2A
12	1.060	26.92	0.784	19.91	1.035	26.29	.7500.1P-.3L-TS-2A	0.585	14.86	.8125-28 UN-2A	.6250-24 UNEF-2A
15	1.203	30.56	0.970	24.64	1.173	29.79	.9375.1P-.3L-TS-2A	0.687	17.45	1.0000-28 UN-2A	.7500-20 UNEF-2A
18	1.389	35.28	1.147	29.13	1.359	34.52	1.1250.1P-.3L-TS-2A	0.884	22.45	1.1875-28 UN-2A	.9375-20 UNEF-2A
19	1.450	36.83	1.221	31.01	1.420	36.07	1.1875.1P-.3L-TS-2A	0.884	22.45	1.2500-28 UN-2A	.9375-20 UNEF-2A
23	1.705	43.31	1.470	37.34	1.675	42.55	1.4375.1P-.3L-TS-2A	1.134	28.80	1.5000-28 UN-2A	1.1875-18 UNEF-2A

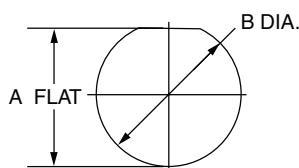

JAM NUT PANEL CUTOUT				
SHELL SIZE	A FLAT		B DIA	
	IN. ±.002	MM. ± 0.05	IN. ±.005	MM. ± 0.13
8	0.543	13.79	0.572	14.53
9	0.669	16.99	0.698	17.73
10	0.669	16.99	0.698	17.73
11	0.729	18.51	0.760	19.30
12	0.792	20.17	0.822	20.88
15	0.978	24.84	1.010	25.65
18	1.155	29.34	1.198	30.43
19	1.231	31.27	1.260	32.00
23	1.480	37.59	1.510	38.35

All dimensions in inches (millimeters in blue)

**SQUARE FLANGED GASKETS**

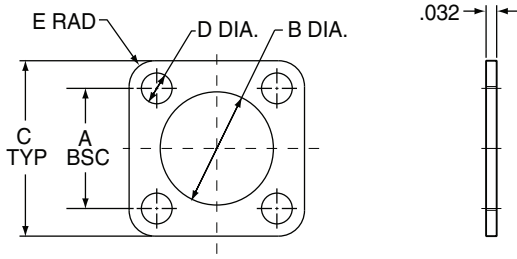

SHELL SIZE	PART NUMBER			A BSC.		B DIA.		C TYP.		D DIA.		E RAD.	
	FLUOROSILICONE	VITON®	CONDUCTIVE	IN.	MM.	IN.	MM.	IN.	MM.	IN.	MM.	IN.	MM.
5	2M809-108F11	2M809-108V11	2M809-108X11	0.363	9.22	0.342	8.69	0.530	13.46	0.093	2.36	0.078	1.98
6	2M809-108F12	2M809-108V12	2M809-108X12	0.423	10.74	0.405	10.29	0.590	14.99	0.093	2.36	0.078	1.98
7	2M809-108F13	2M809-108V13	2M809-108X13	0.483	12.27	0.467	11.86	0.650	16.51	0.093	2.36	0.078	1.98
8	2M809-108F14	2M809-108V14	2M809-108X14	0.542	13.84	0.530	13.46	0.712	18.08	0.093	2.36	0.078	1.98
9	2M809-108F16	2M809-108V16	2M809-108X16	0.719	15.42	0.560	14.22	0.850	21.59	0.125	3.18	0.105	2.67
10	2M809-108F15	2M809-108V15	2M809-108X15	0.719	17.02	0.655	16.64	0.890	22.61	0.125	3.18	0.105	2.67
13	2M809-108F17	2M809-108V17	2M809-108X17	0.812	20.62	0.842	21.39	1.030	26.16	0.125	3.18	0.105	2.67
16	2M809-108F18	2M809-108V18	2M809-108X18	0.981	24.92	1.030	26.16	1.219	30.96	0.125	3.18	0.105	2.67
17	2M809-108F19	2M809-108V19	2M809-108X19	1.060	26.92	1.092	27.74	1.280	32.51	0.125	3.18	0.105	2.67
21	2M809-108F43	2M809-108V43	2M809-108X43	1.322	33.58	1.332	33.83	1.570	39.88	0.125	3.18	0.105	2.67

**SHRINK BOOTS FOR INTEGRAL ENDBELL**

**High Performance Elastomer**

Pre-Coated with high-temperature adhesive

- Operating temperature -94 F to +302 F (-70 C to +150 C)
- Rated for 3000 hours of continuous operation at +302 F (+150 C)
- Excellent resistance to fuels, oils, and solvents
- Spec VG95343 Part 6

**Zero-Halogen**

Low-Smoke, Zero-Halogen Toxicity Requirements

- Meets U.S. and E.U. standards
- Pre-coated with high-temperature adhesive
- Operating temperature -22 F to +257 F (-30 C to +125 C)
- Good resistance to fuels, oils, and solvents
- Spec NAVSEA 5617649

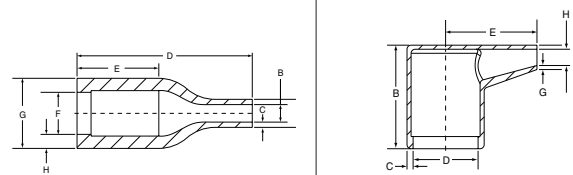

BOOT SIZE	SHELL SIZE	HIGH-PERFORMANCE ELASTOMER		ZERO-HALOGEN		STRAIGHT BOOT CABLE RANGE		MIN.		MAX.		RIGHT ANGLE BOOT CABLE RANGE		MIN.		MAX.	
		STRAIGHT	RIGHT ANGLE	STRAIGHT	RIGHT ANGLE	MAX.		MIN.		MAX.		MIN.		MAX.			
						IN.	MM.	IN.	MM.	IN.	MM.	IN.	MM.				
1	5	2M809S060-1	2M809A060-1	2M809S060-1H	2M809A060-1H *	0.350	9.0	0.080	2.0	0.240	6.0	0.080	2.0	0.240	6.0		
2	6, 7	2M809S060-2	2M809A060-2	2M809S060-2H	2M809A060-2H	0.650	16.5	0.150	3.8	0.650	16.5	0.100	2.5	0.650	16.5		
3	8, 9	2M809S060-3	2M809A060-3	2M809S060-3H	2M809A060-3H	0.920	23.4	0.220	5.6	0.920	23.3	0.220	5.6	0.920	23.3		
4	10, 13	2M809S060-4	2M809A060-4	2M809S060-4H	2M809A060-4H	1.120	28.4	0.260	6.6	1.120	28.5	0.250	6.3	1.120	28.5		
5	16, 17	2M809S060-5	2M809A060-5	2M809S060-5H	2M809A060-5H	1.220	31.0	0.280	7.1	1.220	30.9	0.280	7.1	1.220	30.9		
6	21	2M809S060-6	2M809A060-6	2M809S060-6H	2M809A060-6H	1.680	42.7	0.390	9.9	1.680	42.6	0.380	9.7	1.680	42.6		

\* Size 1 Zero-halogen right-angle supplied less lip, see graphic

DUSTCAPS



SHELL SIZE FOR 2M801	METAL DUSTCAPS WITH NYLON ROPE LANYARD		
	FOR PLUGS WITH RING ATTACHMENT	FOR FLANGED RECEPTACLES WITH RING ATTACHMENT	FOR JAM NUT RECEPTACLES WITH LARGE RING ATTACHMENT
5	2M667-217-XX-G502-4	2M667-218-XX-G501-3	2M667-218-XX-G514-4
6	2M667-217-XX-G602-4	2M667-218-XX-G601-3	2M667-218-XX-G615-4
7	2M667-217-XX-G702-4	2M667-218-XX-G701-3	2M667-218-XX-G716-4
8	2M667-217-XX-G802-4	2M667-218-XX-G801-3	2M667-218-XX-G816-4
9	2M667-217-XX-G902-4	2M667-218-XX-G902-3	2M667-218-XX-G917-4
10	2M667-217-XX-G1002-5	2M667-218-XX-G1002-3	2M667-218-XX-G1018-4
13	2M667-217-XX-G1302-5	2M667-218-XX-G1302-3	2M667-218-XX-G1319-4
16	2M667-217-XX-G1602-6	2M667-218-XX-G1602-3	2M667-218-XX-G1620-4
17	2M667-217-XX-G1702-6	2M667-218-XX-G1702-3	2M667-218-XX-G1721-4
21	2M667-217-XX-G2102-6	2M667-218-XX-G2102-3	2M667-218-XX-G1724-4

- C** Aluminum/ Black Anodize (Non-Conductive) (RoHS)
- M** Aluminum/ Electroless Nickel (RoHS)
- NF** Aluminum/ Cadmium with Olive Drab Chromate
- MT** Aluminum/ Nickel-PTFE (Duralon) (RoHS)

- Z1** Stainless Steel/ Passivated
  - ZN** Aluminum/ Zinc-Nickel with Olive Drab Chromate
  - ZNU** Aluminum/ Zinc-Nickel with Black Chromate (RoHS)
- REPLACE XX WITH PLATING CODE**





STRAIN RELIEF CABLE CLAMP WITH ROTATABLE COUPLING

SHELL SIZE	PART NUMBER	THREAD SIZE 2B	CABLE ENTRY DIA.
5	2M620MS065-XX05	.2500-32 UNEF	0.11
6	2M620MS065-XX06	.3125-32 UNEF	0.17
7	2M620MS065-XX07	.4375-28 UNEF	0.23
8	2M620MS065-XX08	.5000-28 UNEF	0.30
9	2M620MS065-XX09	.5625-24 UNEF	0.30
10	2M620MS065-XX10	.6250-24 UNEF	0.36
13	2M620MS065-XX12	.6875-24 UNEF	0.42
16	2M620MS065-XX14	.9375-20 UNEF	0.48
17	2M620MS065-XX15	.9375-20 UNEF	0.61
21	2M620MS065-XX17	1.1875-18 UNEF	0.86

- C** Aluminum/ Black Anodize (Non-Conductive) (RoHS)
- M** Aluminum/ Electroless Nickel (RoHS)
- NF** Aluminum/ Cadmium with Olive Drab Chromate
- MT** Aluminum/ Nickel-PTFE (Duralon) (RoHS)
- Z1** Stainless Steel/ Passivated
- ZN** Aluminum/ Zinc-Nickel with Olive Drab Chromate
- ZNU** Aluminum/ Zinc-Nickel with Black Chromate (RoHS)

**REPLACE XX WITH PLATING CODE**

ADDITIONAL BACKSHELLS

	DESCRIPTION	PART NUMBER PREFIX	STRAIGHT	90°	45°
	Thread-On BAND-IT Adapter	2M440MS135	X		
		2M440ML135		X	
		2M440MK135			X
	Low-Profile BAND-IT Adapter	2M440MS134	X		
	Environmental Backshell	2M370MS038	X		
		2M370MA038		X	
		2M370MB038			X
	EMI Backshell	2M380MS137	X		
		2M380MA137		X	
		2M380MB137			X
	Environmental EMI Backshell	2M390MS077	X		
		2M390MA077		X	
		2M390MB077			X

2 HOLE FLANGED GASKETS

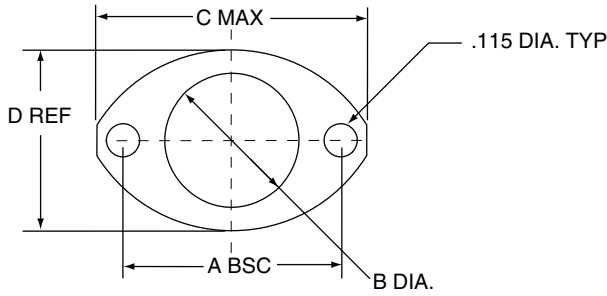

SHELL SIZE	PART NUMBER			A BSC.		B DIA.		C TYP.		D DIA.	
	FLUOROSILICONE	VITON®	CONDUCTIVE	IN.	MM.	IN.	MM.	IN.	MM.	IN.	MM.
5	2M809-108F31	2M809-108V31	2M809-108X31	0.513	13.03	0.345	8.00	0.710	18.03	0.460	11.68
6	2M809-108F32	2M809-108V32	2M809-108X32	0.598	15.19	0.405	10.29	0.795	20.19	0.522	13.26
7	2M809-108F33	2M809-108V33	2M809-108X33	0.708	17.98	0.475	12.07	0.900	22.86	0.590	14.99
8	2M809-108F34	2M809-108V34	2M809-108X34	0.964	24.51	0.545	13.84	1.160	29.46	0.670	17.02
9	2M809-108F35	2M809-108V35	2M809-108X35	1.017	25.83	0.605	15.37	1.215	30.86	0.721	18.31
10	2M809-108F36	2M809-108V36	2M809-108X36	1.101	27.97	0.682	17.32	1.295	32.89	0.795	20.19
12	2M809-108F37	2M809-108V37	2M809-108X37	1.204	30.58	0.757	19.23	1.400	35.56	0.874	22.20
14	2M809-108F38	2M809-108V38	2M809-108X38	1.280	32.51	0.910	23.11	1.555	39.50	1.050	26.67
17	2M809-108F19	2M809-108V19	2M809-108X19	1.060	26.92	1.092	27.74	1.280	32.51	0.125	3.18
21	2M809-108F43	2M809-108V43	2M809-108X43	1.322	33.58	1.332	33.83	1.570	39.88	0.125	3.18

SHRINK BOOTS FOR INTEGRAL ENDBELL

High-Performance Elastomer

Pre-Coated with high-temperature adhesive

- Operating temperature -94 F to +302 F (-70 C to +150 C)
- Rated for 3000 hours of continuous operation at +302 F (+150 C)
- Excellent resistance to fuels, oils, and solvents
- Spec VG95343 Part 6

Zero-Halogen

Low-Smoke, Zero-Halogen Toxicity Requirements

- Meets U.S. and E.U. standards
- Pre-coated with high-temperature adhesive
- Operating temperature -22 F to +257 F (-30 C to +125 C)
- Good resistance to fuels, oils, and solvents
- Spec NAVSEA 5617649

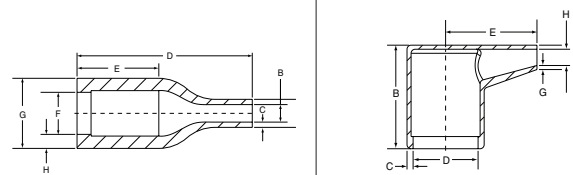

BOOT SIZE	SHELL SIZE	HIGH-PERFORMANCE ELASTOMER		ZERO-HALOGEN		STRAIGHT BOOT CABLE RANGE		MIN.		MAX.		RIGHT ANGLE BOOT CABLE RANGE		MIN.		MAX.	
		STRAIGHT	RIGHT ANGLE	STRAIGHT	RIGHT ANGLE	IN.	MM.	IN.	MM.	IN.	MM.	IN.	MM.	IN.	MM.	IN.	MM.
1	5	2M809S060-1	2M809A060-1	2M809S060-1H	2M809A060-1H *	0.350	9.0	0.080	2.0	0.240	6.0	0.080	2.0				
2	6, 7	2M809S060-2	2M809A060-2	2M809S060-2H	2M809A060-2H	0.650	16.5	0.150	3.8	0.650	16.5	0.100	2.5				
3	8, 9	2M809S060-3	2M809A060-3	2M809S060-3H	2M809A060-3H	0.920	23.4	0.220	5.6	0.920	23.3	0.220	5.6				
4	10, 12	2M809S060-4	2M809A060-4	2M809S060-4H	2M809A060-4H	1.120	28.4	0.260	6.6	1.120	28.5	0.250	6.3				
5	14	2M809S060-5	2M809A060-5	2M809S060-5H	2M809A060-5H	1.220	31.0	0.280	7.1	1.220	30.9	0.280	7.1				

\* Size 1 zero-halogen right-angle supplied less lip, see graphic

## DUSTCAPS



SHELL SIZE FOR 2M803	METAL DUSTCAPS WITH NYLON ROPE LANYARD		
	FOR PLUGS WITH RING ATTACHMENT	FOR FLANGED RECEPTACLES WITH RING ATTACHMENT	FOR JAM NUT RECEPTACLES WITH LARGE RING ATTACHMENT
5	2M660-082-XX-G502-4	2M660-083-XX-G501-3	2M660-083-XX-G514-4
6	2M660-082-XX-G602-4	2M660-083-XX-G601-3	2M660-083-XX-G615-4
7	2M660-082-XX-G702-4	2M660-083-XX-G701-3	2M660-083-XX-G716-4
8	2M660-082-XX-G802-4	2M660-083-XX-G801-3	2M660-083-XX-G817-4
9	2M660-082-XX-G902-4	2M660-083-XX-G902-3	2M660-083-XX-G918-4
10	2M660-082-XX-G1002-5	2M660-083-XX-G1002-3	2M660-083-XX-G1019-4
12	2M660-082-XX-G1202-5	2M660-083-XX-G1202-3	2M660-083-XX-G1219-4
14	2M660-082-XX-G1402-6	2M660-083-XX-G1402-3	2M660-083-XX-G1420-4

**C** Aluminum/ Black Anodize (Non-Conductive) (RoHS)  
**M** Aluminum/ Electroless Nickel (RoHS)  
**NF** Aluminum/ Cadmium with Olive Drab Chromate  
**MT** Aluminum/ Nickel-PTFE (Duralon) (RoHS)

**Z1** Stainless Steel/ Passivated  
**ZN** Aluminum/ Zinc-Nickel with Olive Drab Chromate  
**ZNU** Aluminum/ Zinc-Nickel with Black Chromate (RoHS)  
**REPLACE XX WITH PLATING CODE**

## STRAIN RELIEF CABLE CLAMP WITH ROTATABL COUPLING

SHELL SIZE	PART NUMBER	THREAD SIZE 2B	CABLE ENTRY DIA.
5	2M620MS065-XX05	.2500-32 UNEF	0.11
6	2M620MS065-XX06	.3125-32 UNEF	0.17
7	2M620MS065-XX07	.4375-28 UNEF	0.23
8	2M620MS065-XX08	.5000-28 UNEF	0.30
9	2M620MS065-XX09	.5625-24 UNEF	0.30
10	2M620MS065-XX10	.6250-24 UNEF	0.36
12	2M620MS065-XX12	.6875-24 UNEF	0.42
14	2M620MS065-XX14	.9375-20 UNEF	0.48

**C** Aluminum/ Black Anodize (Non-Conductive) (RoHS)  
**M** Aluminum/ Electroless Nickel (RoHS)  
**NF** Aluminum/ Cadmium with Olive Drab Chromate  
**MT** Aluminum/ Nickel-PTFE (Duralon) (RoHS)  
**Z1** Stainless Steel/ Passivated  
**ZN** Aluminum/ Zinc-Nickel with Olive Drab Chromate  
**ZNU** Aluminum/ Zinc-Nickel with Black Chromate (RoHS)  
**REPLACE XX WITH PLATING CODE**

## ADDITIONAL BACKSHELLS

	DESCRIPTION	PART NUMBER PREFIX	STRAIGHT	90°	45°
	Thread-On BAND-IT Adapter	2M440MS135	X		
		2M440ML135		X	
		2M440MK135			X
	Low-Profile BAND-IT Adapter	2M440MS134	X		
	Environmental Backshell	2M370MS038	X		
		2M370MA038		X	
		2M370MB038			X
	EMI Backshell	2M380MS137	X		
		2M380MA137		X	
		2M380MB137			X
	Environmental EMI Backshell	2M390MS077	X		
		2M390MA077		X	
		2M390MB077			X

## SHRINK BOOTS FOR INTEGRAL ENDBELL

### High Performance Elastomer

Pre-Coated with high-temperature adhesive

- Operating temperature -94 F to +302 F (-70 C to +150 C)
- Rated for 3000 hours of continuous operation at +302 F (+150 C)
- Excellent resistance to fuels, oils, and solvents
- Spec VG95343 Part 6

### Zero Halogen

Low-Smoke, Zero-Halogen Toxicity Requirements

- Meets U.S. and E.U. standards
- Pre-coated with high-temperature adhesive
- Operating temperature -22 F to +257 F (-30 C to +125 C)
- Good resistance to fuels, oils, and solvents
- Spec NAVSEA 5617649

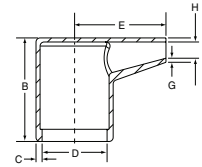
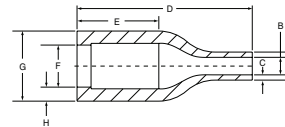

BOOT SIZE	SHELL SIZE	HIGH-PERFORMANCE ELASTOMER				ZERO-HALOGEN				STRAIGHT BOOT CABLE RANGE		RIGHT ANGLE BOOT CABLE RANGE	
		STRAIGHT		RIGHT ANGLE		STRAIGHT		RIGHT ANGLE		MAX.		MIN.	
		IN.	MM.	IN.	MM.	IN.	MM.	IN.	MM.	IN.	MM.	IN.	MM.
1	5	2M809S060-1	2M809A060-1	2M809S060-1H	2M809A060-1H *	0.350	9.0	0.080	2.0	0.240	6.0	0.080	2.0
2	6, 7	2M809S060-2	2M809A060-2	2M809S060-2H	2M809A060-2H	0.650	16.5	0.150	3.8	0.650	16.5	0.100	2.5
3	8, 9	2M809S060-3	2M809A060-3	2M809S060-3H	2M809A060-3H	0.920	23.4	0.220	5.6	0.920	23.3	0.220	5.6
4	10, 12	2M809S060-4	2M809A060-4	2M809S060-4H	2M809A060-4H	1.120	28.4	0.260	6.6	1.120	28.5	0.250	6.3
5	14	2M809S060-5	2M809A060-5	2M809S060-5H	2M809A060-5H	1.220	31.0	0.280	7.1	1.220	30.9	0.280	7.1

\* Size 1 Zero-halogen right-angle supplied less lip, see graphic

## METAL DUSTCAPS



SHELL SIZE FOR 2M804	METAL DUSTCAPS WITH NYLON ROPE LANYARD			
	FOR PLUGS WITH RING ATTACHMENT	FOR FLANGED RECEPTACLES WITH RING ATTACHMENT	FOR JAM NUT RECEPTACLES REAR MOUNT WITH LARGE RING ATTACHMENT	FOR JAM NUT RECEPTACLES FRONT MOUNT WITH LARGE RING ATTACHMENT
5	2M809-198-XX5-G02-4	2M667-202-XX5-G01-3R	2M667-202-XX5-G14-4R	2M667-202-XX5-G16-4R
6	2M809-198-XX6-G02-4	2M667-202-XX6-G01-3R	2M667-202-XX6-G15-4R	2M667-202-XX6-G16-4R
7	2M809-198-XX7-G02-4	2M667-202-XX7-G01-3R	2M667-202-XX7-G16-4R	2M667-202-XX7-G18-4R
8	2M809-198-XX8-G02-4	2M667-202-XX8-G01-3R	2M667-202-XX8-G16-4R	2M667-202-XX8-G18-4R
9	2M809-198-XX9-G02-4	2M667-202-XX9-G02-3R	2M667-202-XX9-G17-4R	2M667-202-XX9-G19-4R
10	2M809-198-XX10-G02-5	2M667-202-XX10-G02-3R	2M667-202-XX10-G18-4R	2M667-202-XX10-G19-4R
12	2M809-198-XX12-G02-5	2M667-202-XX12-G02-3R	2M667-202-XX12-G19-4R	2M667-202-XX12-G20-4R
14	2M809-198-XX14-G02-6	2M667-202-XX14-G02-3R	2M667-202-XX14-G20-4R	2M667-202-XX14-G20-4R

- C** Aluminum/ Black Anodize (Non-Conductive) (RoHS)
- M** Aluminum/ Electroless Nickel (RoHS)
- NF** Aluminum/ Cadmium with Olive Drab Chromate
- MT** Aluminum/ Nickel-PTFE (Duralon) (RoHS)

- Z1** Stainless Steel/ Passivated
  - ZN** Aluminum/ Zinc-Nickel with Olive Drab Chromate
  - ZNU** Aluminum/ Zinc-Nickel with Black Chromate (RoHS)
- REPLACE XX WITH PLATING CODE**

## RUBBER DUSTCAPS



SHELL SIZE FOR 2M804	RUBBER NON-CONDUCTIVE DUSTCAPS WITH NYLON ROPE LANYARD		
	FOR PLUG WITH RING ATTACHMENT	FOR FLANGED RECEPTACLE WITH RING ATTACHMENT	FOR JAM NUT RECEPTACLES FRONT MOUNT WITH LARGE RING ATTACHMENT
5	2M809-083-5G4-02	2M809-087-5G4-15	2M809-087-5G4-08
6	2M809-083-6G4-02	2M809-087-6G4-08	2M809-087-6G4-16
7	2M809-083-7G4-02	2M809-087-7G4-17	2M809-087-7G4-18
8	2M809-083-8G4-02	2M809-087-8G4-17	2M809-087-8G4-18
9	2M809-083-9G4-02	2M809-087-9G4-18	2M809-087-9G4-10
10	2M809-083-10G5-02	2M809-087-10G4-10	2M809-087-10G4-25
12	2M809-083-12G5-02	2M809-087-12G4-19	2M809-087-12G4-12
14	2M809-083-14G6-02	2M809-087-14G4-12	2M809-087-14G4-20

## STRAIN RELIEF CABLE CLAMP WITH ROTATABLE COUPLING

SHELL SIZE	PART NUMBER	THREAD SIZE 2B	CABLE ENTRY DIA.
5	2M620MS065-XX05	.2500-32 UNEF	0.11
6	2M620MS065-XX06	.3125-32 UNEF	0.17
7	2M620MS065-XX07	.4375-28 UNEF	0.23
8	2M620MS065-XX08	.5000-28 UNEF	0.30
9	2M620MS065-XX09	.5625-24 UNEF	0.30
10	2M620MS065-XX10	.6250-24 UNEF	0.36
12	2M620MS065-XX12	.6875-24 UNEF	0.42
14	2M620MS065-XX14	.9375-20 UNEF	0.48

**C** Aluminum/ Black Anodize (Non-Conductive) (RoHS)

**M** Aluminum/ Electroless Nickel (RoHS)

**NF** Aluminum/ Cadmium with Olive Drab Chromate

**MT** Aluminum/ Nickel-PTFE (Duralon) (RoHS)

**Z1** Stainless Steel/ Passivated

**ZN** Aluminum/ Zinc-Nickel with Olive Drab Chromate

**ZNU** Aluminum/ Zinc-Nickel with Black Chromate (RoHS)

**REPLACE XX WITH PLATING CODE**

All Dimensions in inches (millimeters in parenthesis).

## ADDITIONAL BACKSHELLS

	DESCRIPTION	PART NUMBER PREFIX	STRAIGHT	90°	45°
	Thread-On BAND-IT Adapter	2M440MS135	X		
		2M440ML135		X	
		2M440MK135			X
	Low-Profile BAND-IT Adapter	2M440MS134	X		
	Environmental Backshell	2M370MS038	X		
		2M370MA038		X	
		2M370MB038			X
	EMI Backshell	2M380MS137	X		
		2M380MA137		X	
		2M380MB137			X
	Environmental EMI Backshell	2M390MS077	X		
		2M390MA077		X	
		2M390MB077			X



**SQUARE FLANGED GASKETS**

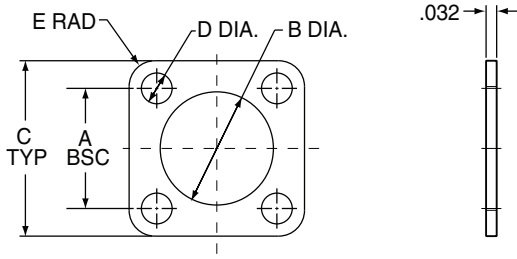

SHELL SIZE	PART NUMBER			A BSC.		B DIA.		C TYP.		D DIA.		E RAD.	
	FLUOROSILICONE	VITON®	CONDUCTIVE	IN.	MM.	IN.	MM.	IN.	MM.	IN.	MM.	IN.	MM.
8	2M809-108F20	2M809-108V20	2M809-108X20	0.660	16.76	0.530	13.46	0.850	21.46	0.093	2.36	0.078	1.98
9	2M809-108F21	2M809-108V21	2M809-108X21	0.723	18.36	0.590	14.99	0.913	23.19	0.093	2.36	0.078	1.98
10	2M809-108F22	2M809-108V22	2M809-108X22	0.785	19.94	0.660	16.76	0.975	24.77	0.093	2.36	0.078	1.98
11	2M809-108F23	2M809-108V23	2M809-108X23	0.848	21.54	0.720	18.29	1.039	26.39	0.093	2.36	0.078	1.98
12	2M809-108F24	2M809-108V24	2M809-108X24	0.909	23.09	0.780	19.81	1.099	27.91	0.093	2.36	0.078	1.98
15	2M809-108F25	2M809-108V25	2M809-108X25	1.058	26.87	0.970	24.64	1.288	32.72	0.125	3.18	0.105	2.67
18	2M809-108F26	2M809-108V26	2M809-108X26	1.255	31.88	1.160	29.46	1.475	37.47	0.125	3.18	0.105	2.67
19	2M809-108F27	2M809-108V27	2M809-108X27	1.327	33.71	1.220	30.99	1.537	39.04	0.125	3.18	0.105	2.67
21	2M809-108F43	2M809-108V43	2M809-108X43	1.322	33.58	1.332	33.83	1.570	39.88	0.125	3.18	0.105	2.67
23	2M809-108F28	2M809-108V28	2M809-108X28	1.570	39.88	1.458	37.03	1.797	45.64	0.125	3.18	0.105	2.67

**SHRINK BOOTS FOR INTEGRAL ENDBELL**

**High-Performance Elastomer**

Pre-Coated with High-Temperature Adhesive

- Operating temperature -94 F to +302 F (-70 C to +150 C)
- Rated for 3000 hours of continuous operation at +302 F (+150 C)
- Excellent resistance to fuels, oils, and solvents
- Spec VG95343 Part 6

**Zero-Halogen**

Low-Smoke, Zero-Halogen Toxicity Requirements

- Meets U.S. and E.U. standards
- Pre-coated with high-temperature adhesive
- Operating temperature -22 F to +257 F (-30 C to +125 C)
- Good resistance to fuels, oils, and solvents
- Spec NAVSEA 5617649

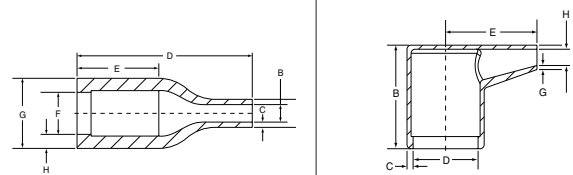

BOOT SIZE	SHELL SIZE	HIGH-PERFORMANCE ELASTOMER		ZERO-HALOGEN		STRAIGHT BOOT CABLE RANGE		MIN.		RIGHT ANGLE BOOT CABLE RANGE		MIN.	
		STRAIGHT	RIGHT ANGLE	STRAIGHT	RIGHT ANGLE	MAX.		MIN.		MAX.		MIN.	
						IN.	MM.	IN.	MM.	IN.	MM.	IN.	MM.
2	8, 9	2M809S060-2	2M809A060-2	2M809S060-2H	2M809A060-2H	0.650	16.5	0.150	3.8	0.650	16.5	0.100	2.5
3	10,11	2M809S060-3	2M809A060-3	2M809S060-3H	2M809A060-3H	0.920	23.4	0.220	5.6	0.920	23.3	0.220	5.6
4	12,15	2M809S060-4	2M809A060-4	2M809S060-4H	2M809A060-4H	1.120	28.4	0.260	6.6	1.120	28.5	0.250	6.3
5	18,19	2M809S060-5	2M809A060-5	2M809S060-5H	2M809A060-5H	1.220	31.0	0.280	7.1	1.220	30.9	0.280	7.1
6	23	2M809S060-6	2M809A060-6	2M809S060-6H	2M809A060-6H	1.680	42.7	0.390	9.9	1.680	42.7	0.380	9.7

DUSTCAPS



SHELL SIZE FOR 2M805	METAL DUSTCAPS WITH NYLON ROPE LANYARD		
	FOR PLUGS WITH RING ATTACHMENT	FOR FLANGED RECEPTACLES WITH RING ATTACHMENT	FOR JAM NUT RECEPTACLES WITH LARGE RING ATTACHMENT
8	2M667-261-XX-G0802-4	2M667-262-XX-G0801-4	2M667-262-XX-G0816-4
9	2M667-261-XX-G0902-4	2M667-262-XX-G0901-4	2M667-262-XX-G0918-4
10	2M667-261-XX-G1002-5	2M667-262-XX-G1001-5	2M667-262-XX-G1018-5
11	2M667-261-XX-G1102-5	2M667-262-XX-G1101-5	2M667-262-XX-G1119-5
12	2M667-261-XX-G1202-5	2M667-262-XX-G1201-5	2M667-262-XX-G1219-5
15	2M667-261-XX-G1502-6	2M667-262-XX-G1502-5	2M667-262-XX-G1520-5
18	2M667-261-XX-G1802-6	2M667-262-XX-G1802-5	2M667-262-XX-G1822-5
19	2M667-261-XX-G1902-6	2M667-262-XX-G1902-5	2M667-262-XX-G1923-5
23	2M667-261-XX-G2302-6	2M667-262-XX-G2302-5	2M667-262-XX-G2325-5

- C** Aluminum/ Black Anodize (Non-Conductive) (RoHS)
- M** Aluminum/ Electroless Nickel (RoHS)
- NF** Aluminum/ Cadmium with Olive Drab Chromate
- MT** Aluminum/ Nickel-PTFE (Duralon) (RoHS)

- Z1** Stainless Steel/ Passivated
  - ZN** Aluminum/ Zinc-Nickel with Olive Drab Chromate
  - ZNU** Aluminum/ Zinc-Nickel with Black Chromate (RoHS)
- REPLACE XX WITH PLATING CODE**

STRAIN RELIEF CABLE CLAMP WITH ROTATABLE COUPLING

SHELL SIZE	PART NUMBER	THREAD SIZE 2B	CABLE ENTRY DIA.
8	2M620MS065-XX11	.2500-32 UNEF	0.11
9	2M620MS065-XX07	.3125-32 UNEF	0.17
10	2M620MS065-XX08	.4375-28 UNEF	0.23
11	2M620MS065-XX09	.5000-28 UNEF	0.30
12	2M620MS065-XX10	.5625-24 UNEF	0.30
15	2M620MS065-XX13	.6250-24 UNEF	0.36
18, 19	2M620MS065-XX14	.9375-20 UNEF	0.48
18, 19	2M620MS065-XX15	.9375-20 UNEF	0.61
23	2M620MS065-XX17	1.1875-18 UNEF	0.86

- C** Aluminum/ Black Anodize (Non-Conductive) (RoHS)
  - M** Aluminum/ Electroless Nickel (RoHS)
  - NF** Aluminum/ Cadmium with Olive Drab Chromate
  - MT** Aluminum/ Nickel-PTFE (Duralon) (RoHS)
  - Z1** Stainless Steel/ Passivated
  - ZN** Aluminum/ Zinc-Nickel with Olive Drab Chromate
  - ZNU** Aluminum/ Zinc-Nickel with Black Chromate (RoHS)
- REPLACE XX WITH PLATING CODE**

ADDITIONAL BACKSHELLS

	DESCRIPTION	PART NUMBER PREFIX	STRAIGHT	90°	45°
	Thread-On BAND-IT Adapter	2M440MS135	X		
		2M440ML135		X	
		2M440MK135			X
	Low-Profile BAND-IT Adapter	2M440MS134	X		
	Environmental Backshell	2M370MS038	X		
		2M370MA038		X	
		2M370MB038			X
	EMI Backshell	2M380MS137	X		
		2M380MA137		X	
		2M380MB137			X
	Environmental EMI Backshell	2M390MS077	X		
		2M390MA077		X	
		2M390MB077			X

## WIRE STRIPPING

Strip insulation from the end of wire to be crimped. (See table for proper stripping dimensions.) Do not cut or damage wire strands.

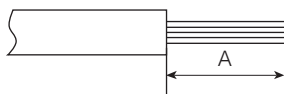

CONTACT SIZE	A
23, 20HD	.150 (3.18)
20	.188 (4.77)
16	.188 (4.77)
12	.188 (4.77)

## CONTACT CRIMPING

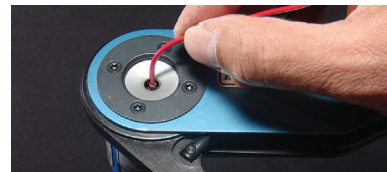
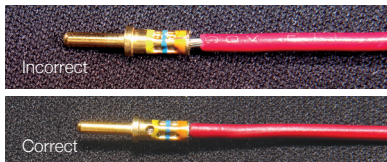

**STEP 1:** Insert wire into rear of contact. Wire insulation must press against rear of contact. Wire must be visible through inspection hole.

**STEP 2:** M22520 series crimp tool and locator is recommended. See Contact and Tool Table on pages 182 and 183 for choice of turret head and selection setting according to contact size, part number and wire gauge size.

**STEP 3:** Insert contact and wire into tool jaws. To crimp, squeeze handles together fully until ratchet releases and allows handles to expand; otherwise, contact cannot be extracted from tool jaws. Maintain slight insertion pressure on wire while crimping contact to wire.

## CONTACT INSERTION

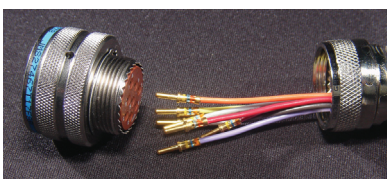

**STEP 1:** Remove hardware from plug or receptacle and slip over wire bundle in proper order for reassembly.

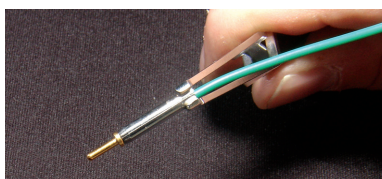

**STEP 2:** Using proper plastic or metal insertion tool for corresponding contact, position wire in tip of the tool so that the tool tip presses against the contact shoulder.

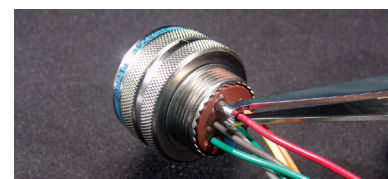

**STEP 3:** Press tool against contact shoulder and, with firm and even pressure, insert wired contact and tool tip into center contact cavity.

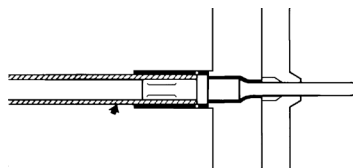

**STEP 4:** When contact bottoms, a slight "click" can be heard as tines of metal retaining clip snap into place behind contact shoulder.

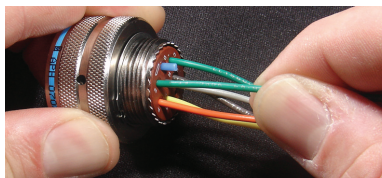

**STEP 5:** Remove tool and pull back lightly on wire to make sure contact is properly seated. Repeat operation with remainder of contacts to be inserted, beginning with the center cavity and working outward in alternating rows.



**STEP 6:** After all contacts are inserted, fill any empty cavities with wire sealing plugs. Reassemble plug or receptacle hardware.

## CONTACT EXTRACTION



**STEP 1:** Remove hardware from plug or receptacle and slide hardware back along wire bundle.

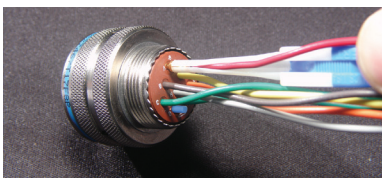

**STEP 2:** Using plastic or metal extraction tool with proper color code corresponding to contact size, place wire in tool.

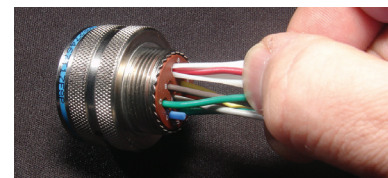

**STEP 3:** Insert tool into contact cavity until tool tip bottoms against the contact shoulder, expanding clip retaining tines.

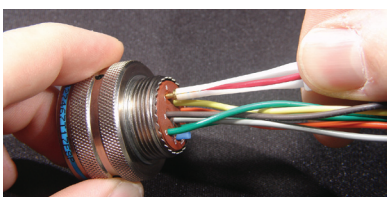

**STEP 4:** Hold wire firmly in tool and extract wired contact and tool. Repeat operation for all contacts to be extracted.



**STEP 5:** Fill any empty cavities with wire sealing plugs. Reassemble plug or receptacle hardware.

All dimensions in inches