

L7558 series

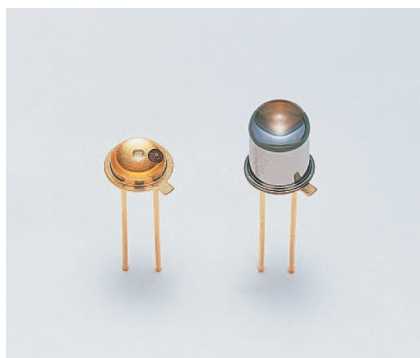

High-speed, high-power infrared LED for free space optics

The L7558 series LEDs were developed for free space optical communications such as image data signal transmission, and operate at high speeds of 50 MHz.

The L7558 delivers a high output of 14 mW and is used in combination with a light projection lens. The L7558-01 is sealed in a metal package capped with a glass lens that produces an angle of view of $\pm 7^\circ$ (full angle at half maximum).

Both types employ a metal stem package that gives higher reliability than plastic package devices.

Features

- High-speed response: 50 MHz typ. ($I_F=50$ mA)
- High radiant output power
L7558 : 14 mW typ. ($I_F=50$ mA)
L7558-01: 7 mW typ. ($I_F=50$ mA)
- High reliability

Applications

- FSO (free space optics)

Absolute maximum ratings ($T_a=25$ °C)

Parameter	Symbol	Condition	Value	Unit
Forward current	I_F		100	mA
Reverse voltage	V_R		5	V
Pulse forward current	I_{FP}	Pulse width=10 μ s Duty ratio=1%	1.0	A
Operating temperature	T_{opr}		-30 to +85	°C
Storage temperature	T_{stg}		-40 to +100 *	°C

* Guaranteed to resist temperature cycle test of up to 5 cycles.

Note: Exceeding the absolute maximum ratings even momentarily may cause a drop in product quality. Always be sure to use the product within the absolute maximum ratings.

Electrical and optical characteristics ($T_a=25$ °C)

Parameter	Symbol	Condition	L7558			L7558-01			Unit
			Min.	Typ.	Max.	Min.	Typ.	Max.	
Peak emission wavelength	λ_p	$I_F=50$ mA	820	850	880	820	850	880	nm
Spectral half width	$\Delta\lambda$	$I_F=50$ mA	-	50	-	-	50	-	nm
Forward voltage	V_F	$I_F=50$ mA	-	1.45	1.60	-	1.45	1.60	V
Pulse forward voltage	V_{FP}	$I_F=1$ A	-	3.4	4.3	-	3.4	4.3	V
Reverse current	I_R	$V_R=5$ V	-	-	10	-	-	10	μ A
Radiant flux	ϕ_e	$I_F=50$ mA	11	14	-	5.5	7.0	-	mW
Radiant illuminance	P_E	$I_F=50$ mA	-	1.5	-	-	4.0	-	mW/cm ²
Cut-off frequency	f_c	$I_F=50$ mA \pm 1mAp-p	35	50	-	35	50	-	MHz

Emission spectrum

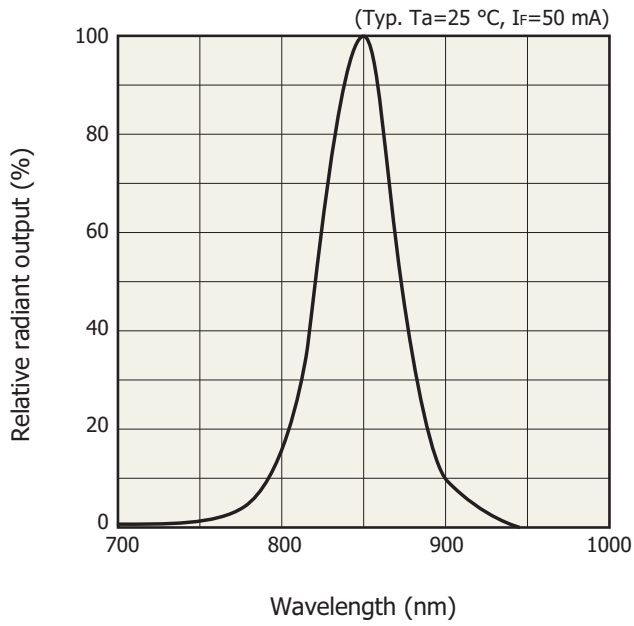

Radiant flux vs. forward current

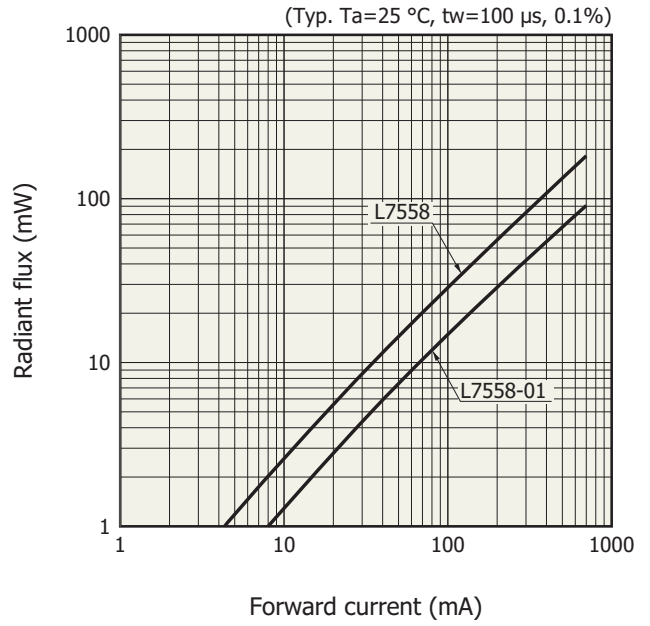

Forward current vs. forward voltage

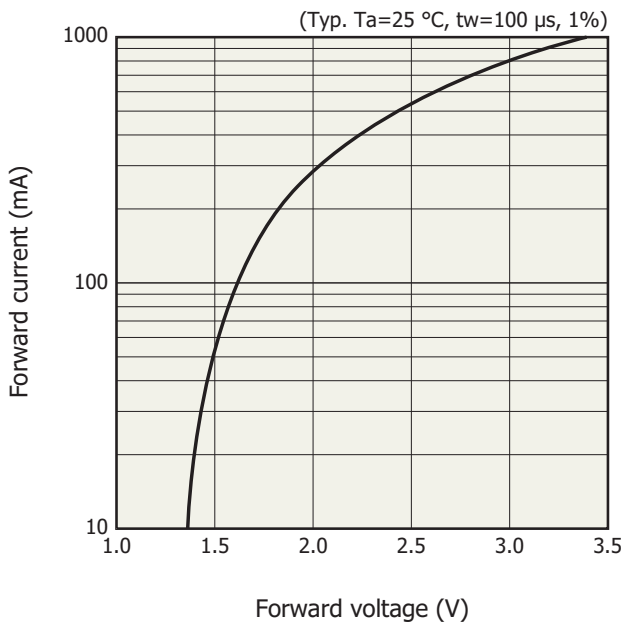

Frequency characteristics

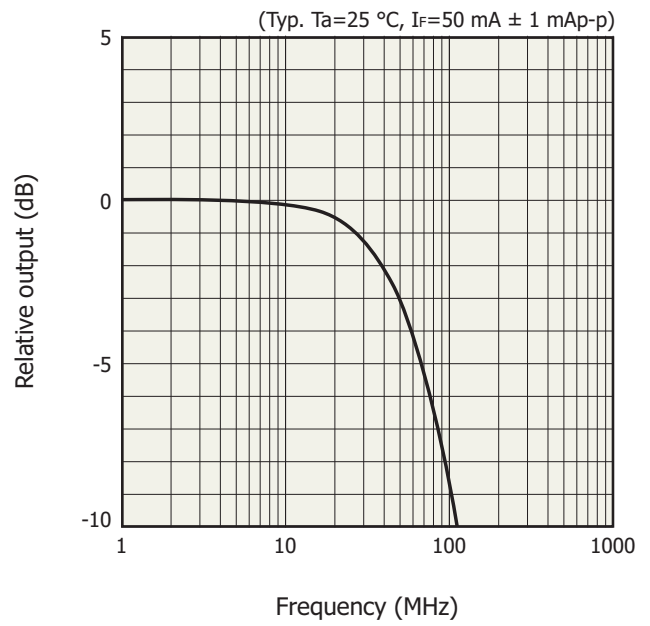

Directivity

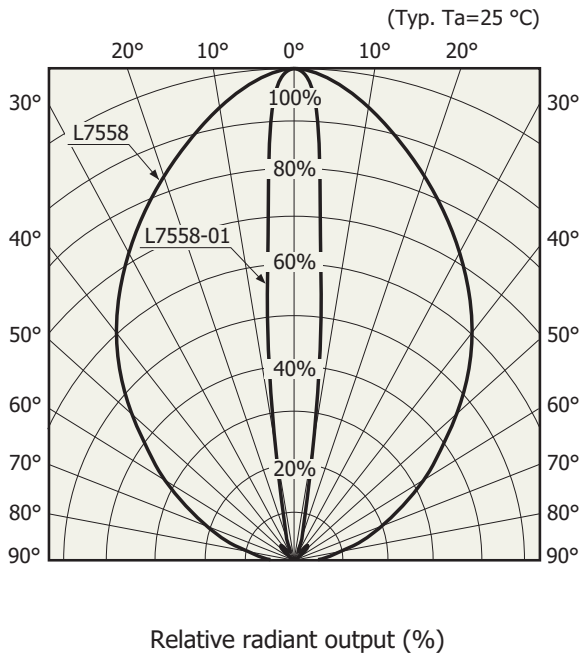

Radiant output vs. ambient temperature

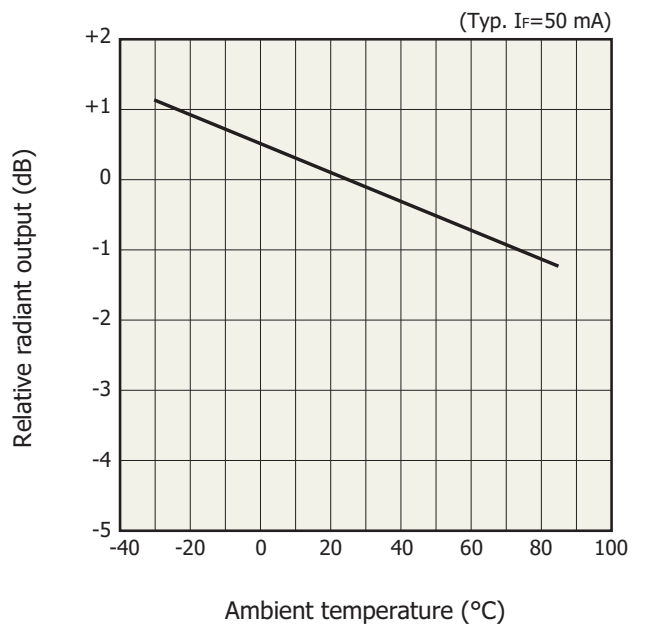

Allowable forward current vs. ambient temperature

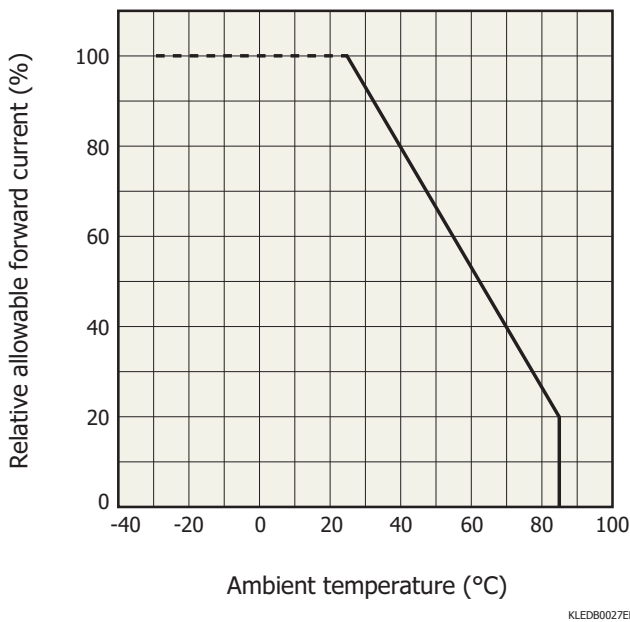

Allowable forward current vs. duty ratio

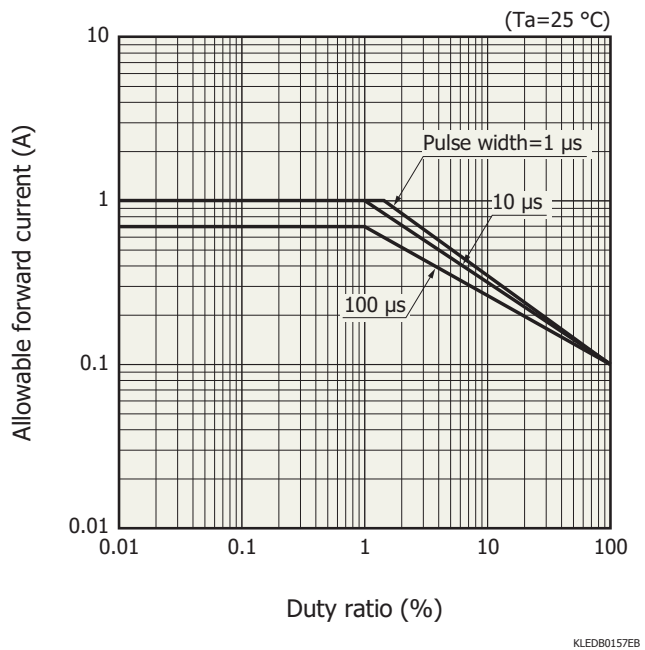

Dimensional outlines (unit: mm)

L7558

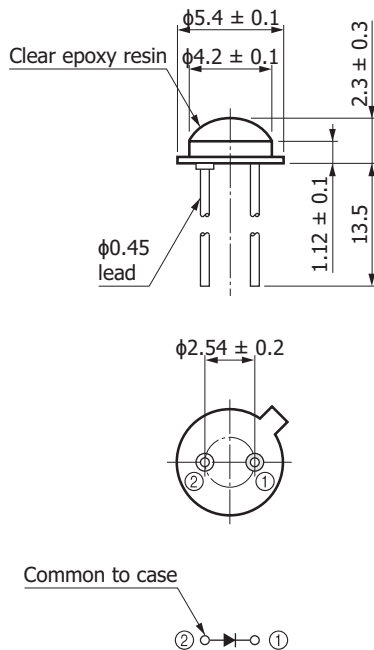

KLEDA0009ED

L7558-01

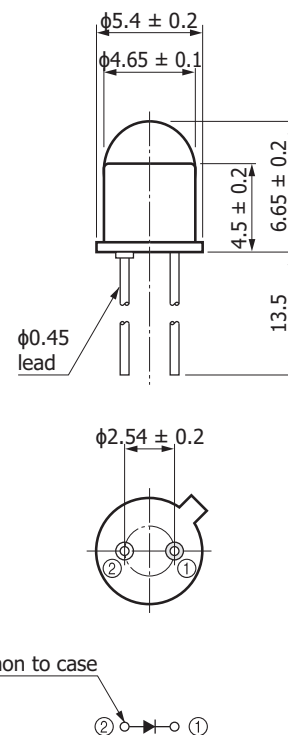

KLEDA0052EB

Related information

www.hamamatsu.com/sp/ssd/doc_en.html

Precautions

- Disclaimer
- Metal, ceramic, plastic products

Information described in this material is current as of November, 2015.

Product specifications are subject to change without prior notice due to improvements or other reasons. This document has been carefully prepared and the information contained is believed to be accurate. In rare cases, however, there may be inaccuracies such as text errors. Before using these products, always contact us for the delivery specification sheet to check the latest specifications.

The product warranty is valid for one year after delivery and is limited to product repair or replacement for defects discovered and reported to us within that one year period. However, even if within the warranty period we accept absolutely no liability for any loss caused by natural disasters or improper product use. Copying or reprinting the contents described in this material in whole or in part is prohibited without our prior permission.

HAMAMATSU

www.hamamatsu.com

HAMAMATSU PHOTONICS K.K., Solid State Division

1126-1 Ichino-cho, Higashi-ku, Hamamatsu City, 435-8558 Japan, Telephone: (81) 53-434-3311, Fax: (81) 53-434-5184

U.S.A.: Hamamatsu Corporation: 360 Foothill Road, Bridgewater, N.J. 08807, U.S.A., Telephone: (1) 908-231-0960, Fax: (1) 908-231-1218

Germany: Hamamatsu Photonics Deutschland GmbH: Arzbergerstr. 10, D-82211 Herrsching am Ammersee, Germany, Telephone: (49) 8152-375-0, Fax: (49) 8152-265-8

France: Hamamatsu Photonics France S.A.R.L.: 19, Rue du Saule Trapu, Parc du Moulin de Massy, 91882 Massy Cedex, France, Telephone: 33-(1) 69 53 71 00, Fax: 33-(1) 69 53 71 10

United Kingdom: Hamamatsu Photonics UK Limited: 2 Howard Court, 10 Tewin Road, Welwyn Garden City, Hertfordshire AL7 1BW, United Kingdom, Telephone: (44) 1707-294888, Fax: (44) 1707-325777

North Europe: Hamamatsu Photonics Norden AB: Torshamnsgatan 35 16440 Kista, Sweden, Telephone: (46) 8-509-031-00, Fax: (46) 8-509-031-01

Italy: Hamamatsu Photonics Italia S.r.l.: Strada della Moia, 1 int. 6, 20020 Arese (Milano), Italy, Telephone: (39) 02-93581733, Fax: (39) 02-93581741

China: Hamamatsu Photonics (China) Co., Ltd.: B1201, Jiaming Center, No.27 Dongsanhuan Beilu, Chaoyang District, Beijing 100020, China, Telephone: (86) 10-6586-6006, Fax: (86) 10-6586-2866