

PV4 Series

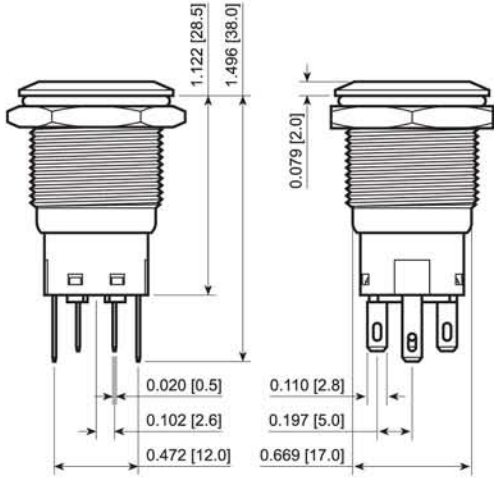

RoHS

Double Throw Style

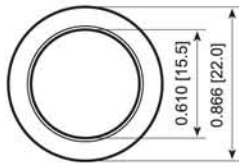

Suggested Panel Cutout

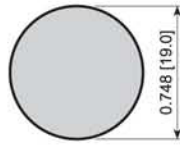

Maximum Panel Thickness: 0.394 [10.0]

Illumination Options

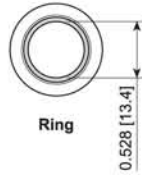
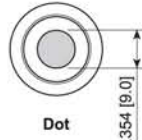

FEATURES:

- Vandal and Water Resistant
- Long Life Expectancy
- Colored Bezel and Actuator Options

SPECIFICATIONS:

RATING: 2A 24VDC; 7A 125VAC (cURus)

ILLUMINATION BASE RATING:

Red, Yellow, and Orange: 20mA 1.8V
Blue, Green, and White: 20mA 2.8V

TEMPERATURE: -20°C to 55°C

ELECTRICAL LIFE: 50,000 Cycles

CONTACT RESISTANCE: 50mΩ Max. at 1A 12VDC

INSULATION RESISTANCE: 1,000MΩ Min. 500VDC

DIELECTRIC STRENGTH: 2,000VAC for 1 Minute

INTRUSION PROTECTION: IP65

MATERIALS:

BUSHING: Stainless Steel
Aluminum

ACTUATOR: Stainless Steel
Aluminum

BASE: Polybutylene Terephthalate, UL94 V-2

SEALING: Silicone

INNER ASSEMBLY: Polyamide 6/6
Brass

SPRING: Stainless Steel

CONTACT: Silver Plated Brass

TERMINALS: Silver Plated Brass

HARDWARE: Nickel Plated Brass

Double Break Style

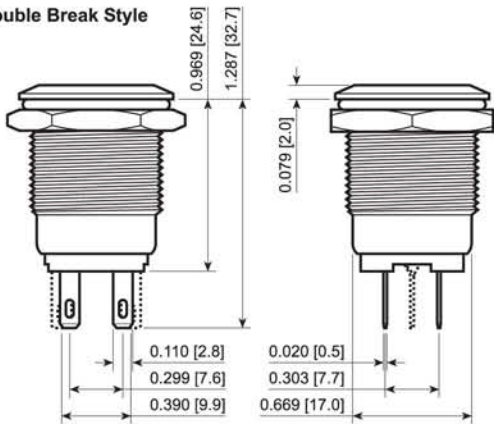

Illumination Options

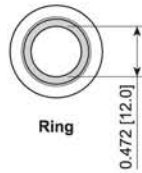
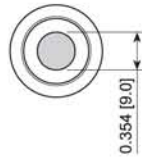

PV4F2Y01S-343



PV4F2Y0SS-244



PV4F2Y0SS-314

PV4F2Y0SS

Series	Actuator Options	Terminal	Function	Rating	Body Finish	Actuator Finish	Contact Material	Lens Style	Lens Color	Illumination Voltage
PV4	F - Flat	2 - Solder 6 - Screw (*)	1 Pole: 3 - On-On B - On-(On)	0 - 2A 48VDC	1 - Black S - Stainless Steel	1 - Black S - Stainless Steel	None - Silver G - Gold	2 - Dot 3 - Ring	0 - White 1 - Red 2 - Orange 3 - Green 4 - Blue 5 - Yellow	1 - Base Voltage 3 - 6V 4 - 12V 5 - 24V 6 - 125V 7 - 250V

Notes:
* = Available with Y function only
Additional material, illumination and marking options available. Please ask your sales person.

2 Pole:
G - On-On
H - On-(On)

Double Break:
Y - 1P Off-(On) + 1P On-(Off)

For Illuminated Switches Only

EXAMPLE PART NUMBERS:

PV4F2Y0SS-201 2P Off-(On), On-(Off)
Stainless Steel Finish, Clear Dot Illum., 2V

PV4F2Y0SS-211 2P Off-(On), On-(Off)
Stainless Steel Finish, Red Dot Illum., 2V

PV4F2Y0SS-214 2P Off-(On), On-(Off)
Stainless Steel Finish, Red Dot Illum., 12V

PV4F2Y0SS-216 2P Off-(On), On-(Off)
Stainless Steel Finish, Red Dot Illum., 125V

PV4F2Y0SS-241 2P Off-(On), On-(Off)
Stainless Steel Finish, Blue Dot Illum., 2V

PV4F2Y0SS-244 2P Off-(On), On-(Off)
Stainless Steel Finish, Blue Dot Illum., 12V

PV4F2Y0SS-301 2P Off-(On), On-(Off)
Stainless Steel Finish, Clear Ring Illum., 2V

PV4F2Y0SS-311 2P Off-(On), On-(Off)
Stainless Steel Finish, Red Ring Illum., 2V

PV4F2Y0SS-314 2P Off-(On), On-(Off)
Stainless Steel Finish, Red Ring Illum., 12V

PV4F2Y0SS-316 2P Off-(On), On-(Off)
Stainless Steel Finish, Red Ring Illum., 125V

PV4F2Y0SS-341 2P Off-(On), On-(Off)
Stainless Steel Finish, Blue Ring Illum., 2V

PV4F2Y0SS-344 2P Off-(On), On-(Off)
Stainless Steel Finish, Blue Ring Illum., 12V

SPECIFICATIONS SUBJECT TO CHANGE WITHOUT NOTICE



E-SWITCH®

www.e-switch.com

800.867.2717