

NTA4001N, NVA4001N

Small Signal MOSFET

20 V, 238 mA, Single, N-Channel, Gate ESD Protection, SC-75



ON Semiconductor®

<http://onsemi.com>

Features

- Low Gate Charge for Fast Switching
- Small 1.6 x 1.6 mm Footprint
- ESD Protected Gate
- AEC-Q101 Qualified and PPAP Capable – NVA4001N
- These Devices are Pb-Free and are RoHS Compliant

Applications

- Power Management Load Switch
- Level Shift
- Portable Applications such as Cell Phones, Media Players, Digital Cameras, PDA's, Video Games, Hand Held Computers, etc.

MAXIMUM RATINGS (T_J = 25°C unless otherwise stated)

Parameter	Symbol	Value	Unit
Drain-to-Source Voltage	V _{DSS}	20	V
Gate-to-Source Voltage	V _{GS}	±10	V
Continuous Drain Current (Note 1)	I _D	238	mA
Power Dissipation (Note 1)	P _D	300	mW
Pulsed Drain Current	I _{DM}	714	mA
Operating Junction and Storage Temperature	T _J , T _{STG}	-55 to 150	°C
Continuous Source Current (Body Diode)	I _{SD}	238	mA
Lead Temperature for Soldering Purposes (1/8" from case for 10 s)	T _L	260	°C

Stresses exceeding Maximum Ratings may damage the device. Maximum Ratings are stress ratings only. Functional operation above the Recommended Operating Conditions is not implied. Extended exposure to stresses above the Recommended Operating Conditions may affect device reliability.

THERMAL RESISTANCE RATINGS

Parameter	Symbol	Max	Unit
Junction-to-Ambient – Steady State (Note 1)	R _{θJA}	416	°C/W

1. Surface-mounted on FR4 board using 1 in sq. pad size (Cu area = 1.127 in sq. [1 oz] including traces).

V _{(BR)DSS}	R _{DS(on)} Typ @ V _{GS}	I _D MAX (Note 1)
20 V	1.5 Ω @ 4.5 V	238 mA
	2.2 Ω @ 2.5 V	

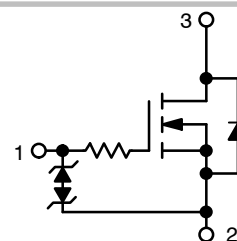

N-Channel

PIN CONNECTIONS

SC-75 (3-Leads)

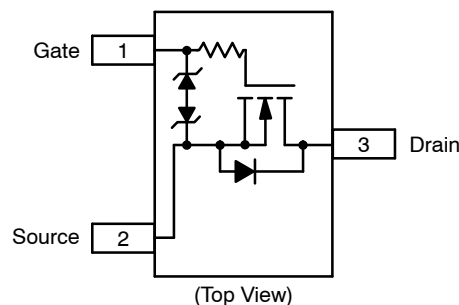

(Top View)

MARKING DIAGRAM

SC-75 / SOT-416
CASE 463
STYLE 5

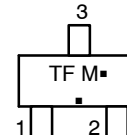

TF = Specific Device Code

M = Date Code

▪ = Pb-Free Package

(Note: Microdot may be in either location)

ORDERING INFORMATION

See detailed ordering and shipping information in the package dimensions section on page 4 of this data sheet.

NTA4001N, NVA4001N

ELECTRICAL CHARACTERISTICS ($T_J = 25^\circ\text{C}$ unless otherwise specified)

Parameter	Symbol	Test Condition	Min	Typ	Max	Unit
-----------	--------	----------------	-----	-----	-----	------

OFF CHARACTERISTICS

Drain-to-Source Breakdown Voltage	$V_{(BR)DSS}$	$V_{GS} = 0\text{ V}, I_D = 100\ \mu\text{A}$	20			V
Zero Gate Voltage Drain Current	I_{DSS}	$V_{GS} = 0\text{ V}, V_{DS} = 20\text{ V}$			1.0	μA
Gate-to-Source Leakage Current	I_{GSS}	$V_{DS} = 0\text{ V}, V_{GS} = \pm 10\text{ V}$			± 100	μA

ON CHARACTERISTICS (Note 2)

Gate Threshold Voltage	$V_{GS(TH)}$	$V_{DS} = 3\text{ V}, I_D = 100\ \mu\text{A}$	0.5	1.0	1.5	V
Drain-to-Source On Resistance	$R_{DS(on)}$	$V_{GS} = 4.5\text{ V}, I_D = 10\text{ mA}$		1.5	3.0	Ω
		$V_{GS} = 2.5\text{ V}, I_D = 10\text{ mA}$		2.2	3.5	
Forward Transconductance	g_{FS}	$V_{DS} = 3\text{ V}, I_D = 10\text{ mA}$		80		mS

CAPACITANCES

Input Capacitance	C_{ISS}	$V_{DS} = 5\text{ V}, f = 1\text{ MHz}, V_{GS} = 0\text{ V}$		11.5	20	pF
Output Capacitance	C_{OSS}			10	15	
Reverse Transfer Capacitance	C_{RSS}			3.5	6.0	

SWITCHING CHARACTERISTICS (Note 3)

Turn-On Delay Time	$t_{d(ON)}$	$V_{GS} = 4.5\text{ V}, V_{DS} = 5\text{ V}, I_D = 10\text{ mA}, R_G = 10\ \Omega$		13		ns
Rise Time	t_r			15		
Turn-Off Delay Time	$t_{d(OFF)}$			98		
Fall Time	t_f			60		

DRAIN-SOURCE DIODE CHARACTERISTICS

Forward Diode Voltage	V_{SD}	$V_{GS} = 0\text{ V}, I_S = 10\text{ mA}$		0.66	0.8	V
-----------------------	----------	-------------------------------------------	--	------	-----	---

2. Pulse Test: pulse width $\leq 300\ \mu\text{s}$, duty cycle $\leq 2\%$.
3. Switching characteristics are independent of operating junction temperatures.

TYPICAL PERFORMANCE CURVES

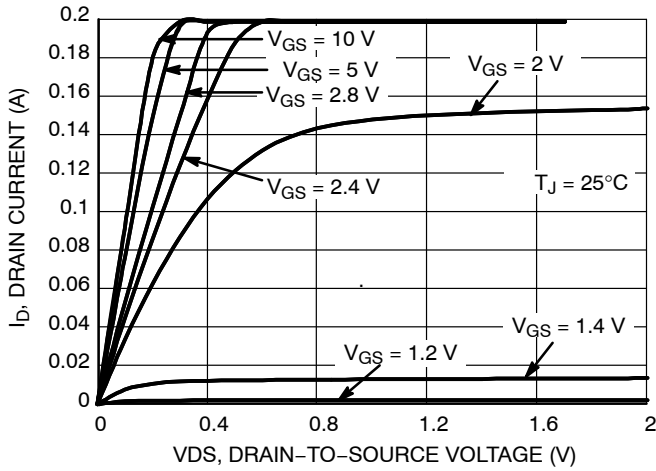

Figure 1. On-region Characteristics

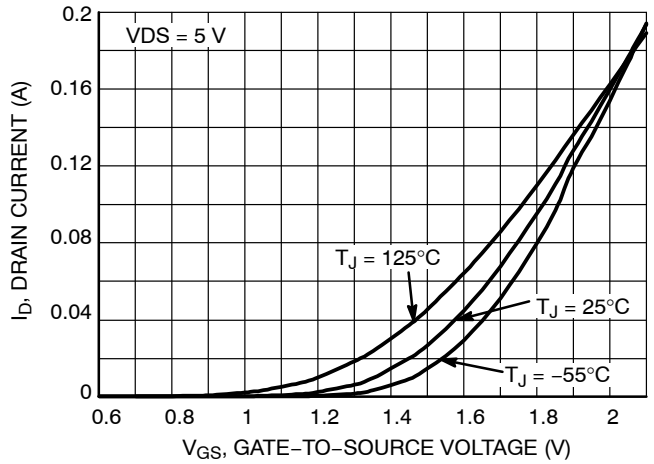

Figure 2. Transfer Characteristics

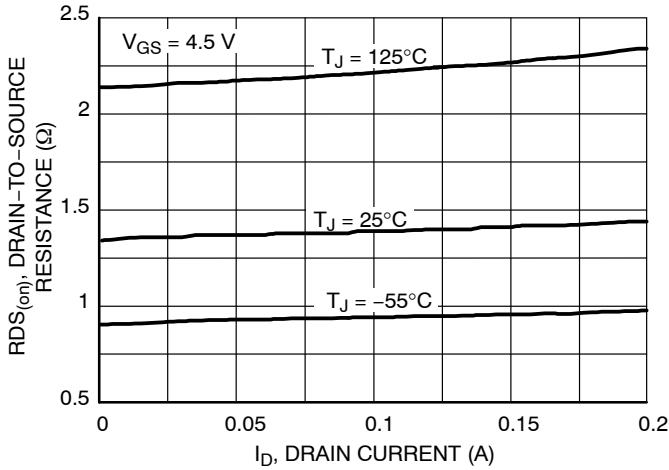

Figure 3. On-resistance versus Drain Current and Temperature

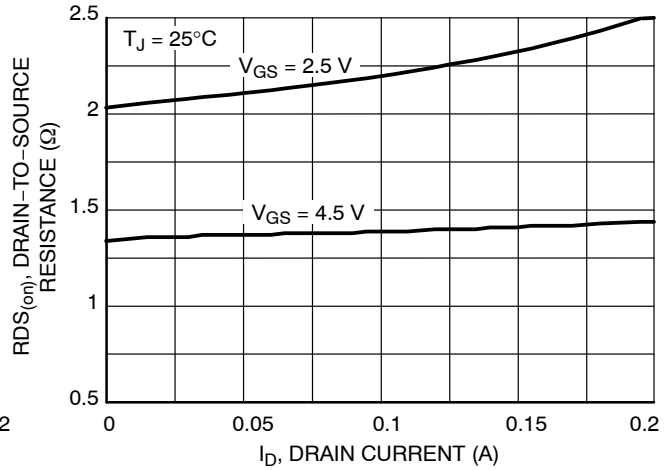

Figure 4. On-resistance versus Drain Current and Gate Voltage

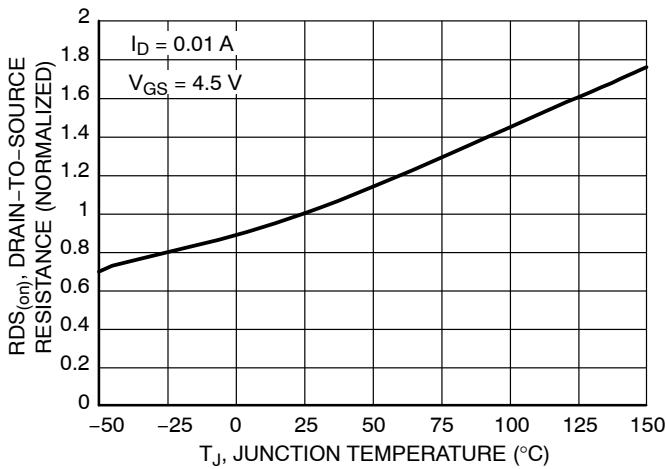

Figure 5. On-resistance Variation with Temperature

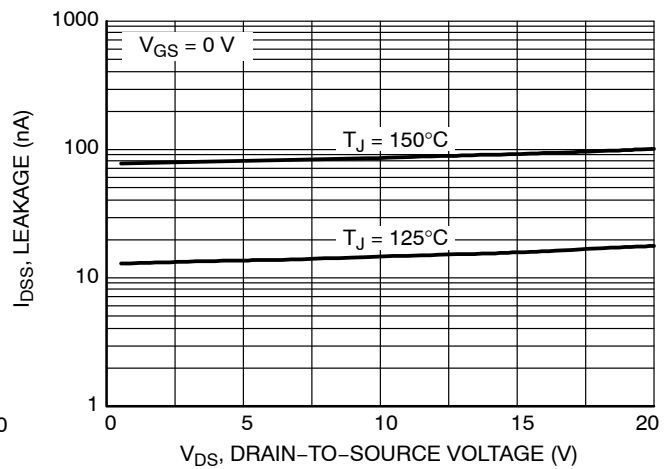
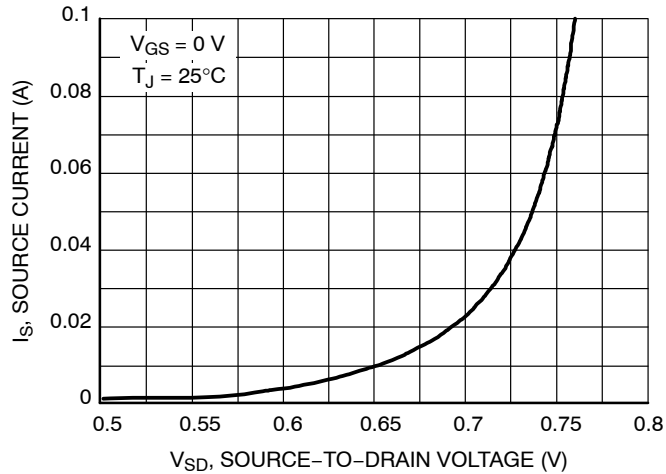
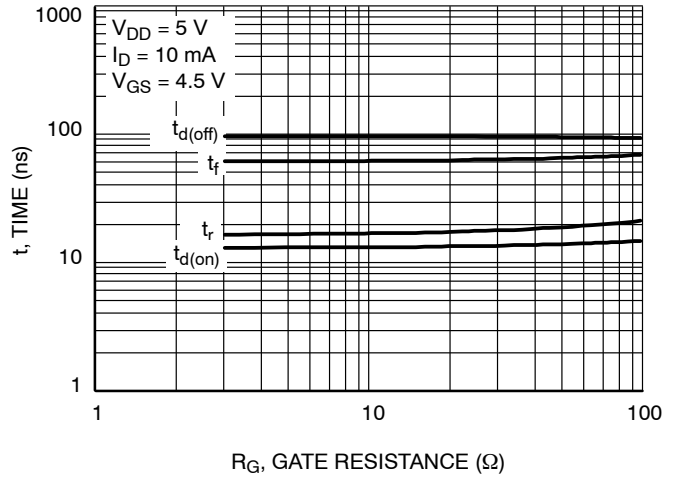
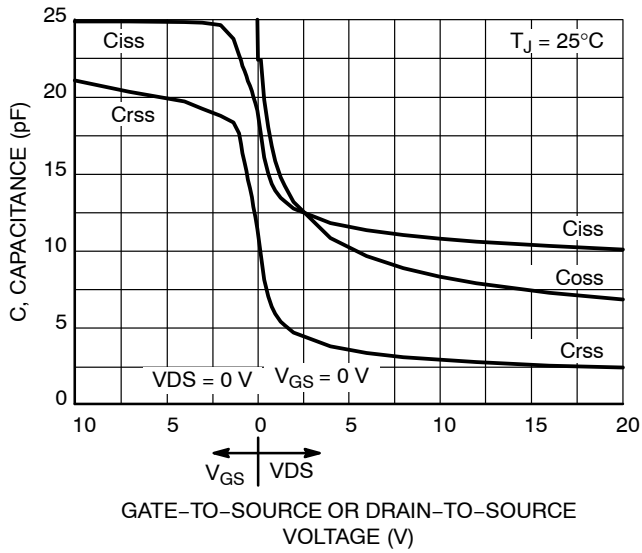

Figure 6. Drain-to-Source Leakage Current versus Voltage

NTA4001N, NVA4001N

TYPICAL PERFORMANCE CURVES



ORDERING INFORMATION

Order Number	Package	Shipping†
NTA4001NT1G	SC-75 (Pb-Free)	3000 / Tape & Reel
NVA4001NT1G	SC-75 (Pb-Free)	3000 / Tape & Reel

†For information on tape and reel specifications, including part orientation and tape sizes, please refer to our Tape and Reel Packaging Specifications Brochure, BRD8011/D.

NTA4001N, NVA4001N

PACKAGE DIMENSIONS

SC-75 / SOT-416
CASE 463-01
ISSUE F

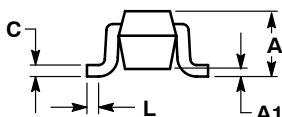
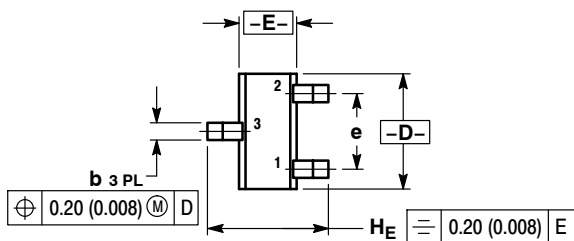

NOTES:

1. DIMENSIONING AND TOLERANCING PER ANSI Y14.5M, 1982.
2. CONTROLLING DIMENSION: MILLIMETER.

DIM	MILLIMETERS			INCHES		
	MIN	NOM	MAX	MIN	NOM	MAX
A	0.70	0.80	0.90	0.027	0.031	0.035
A1	0.00	0.05	0.10	0.000	0.002	0.004
b	0.15	0.20	0.30	0.006	0.008	0.012
C	0.10	0.15	0.25	0.004	0.006	0.010
D	1.55	1.60	1.65	0.059	0.063	0.067
E	0.70	0.80	0.90	0.027	0.031	0.035
e	1.00 BSC			0.04 BSC		
L	0.10	0.15	0.20	0.004	0.006	0.008
H _E	1.50	1.60	1.70	0.061	0.063	0.065

STYLE 5:

- PIN 1. GATE
- SOURCE
- DRAIN

SOLDERING FOOTPRINT*

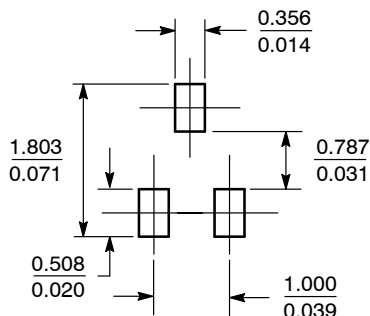

SCALE 10:1 (mm/inches)

*For additional information on our Pb-Free strategy and soldering details, please download the ON Semiconductor Soldering and Mounting Techniques Reference Manual, SOLDERRM/D.

ON Semiconductor and are registered trademarks of Semiconductor Components Industries, LLC (SCILLC). SCILLC reserves the right to make changes without further notice to any products herein. SCILLC makes no warranty, representation or guarantee regarding the suitability of its products for any particular purpose, nor does SCILLC assume any liability arising out of the application or use of any product or circuit, and specifically disclaims any and all liability, including without limitation special, consequential or incidental damages. "Typical" parameters which may be provided in SCILLC data sheets and/or specifications can and do vary in different applications and actual performance may vary over time. All operating parameters, including "Typicals" must be validated for each customer application by customer's technical experts. SCILLC does not convey any license under its patent rights nor the rights of others. SCILLC products are not designed, intended, or authorized for use as components in systems intended for surgical implant into the body, or other applications intended to support or sustain life, or for any other application in which the failure of the SCILLC product could create a situation where personal injury or death may occur. Should Buyer purchase or use SCILLC products for any such unintended or unauthorized application, Buyer shall indemnify and hold SCILLC and its officers, employees, subsidiaries, affiliates, and distributors harmless against all claims, costs, damages, and expenses, and reasonable attorney fees arising out of, directly or indirectly, any claim of personal injury or death associated with such unintended or unauthorized use, even if such claim alleges that SCILLC was negligent regarding the design or manufacture of the part. SCILLC is an Equal Opportunity/Affirmative Action Employer. This literature is subject to all applicable copyright laws and is not for resale in any manner.

PUBLICATION ORDERING INFORMATION

LITERATURE FULFILLMENT:
Literature Distribution Center for ON Semiconductor
P.O. Box 5163, Denver, Colorado 80217 USA
Phone: 303-675-2175 or 800-344-3860 Toll Free USA/Canada
Fax: 303-675-2176 or 800-344-3867 Toll Free USA/Canada
Email: orderlit@onsemi.com

N. American Technical Support: 800-282-9855 Toll Free USA/Canada
Europe, Middle East and Africa Technical Support:
Phone: 421 33 790 2910
Japan Customer Focus Center
Phone: 81-3-5817-1050

ON Semiconductor Website: www.onsemi.com
Order Literature: <http://www.onsemi.com/orderlit>

For additional information, please contact your local Sales Representative