



UM30-215113

UM30

ULTRASONIC SENSORS

SICK
Sensor Intelligence.



Ordering information

| Type | Part no. |
|-------------|----------|
| UM30-215113 | 6036920 |

Other models and accessories → www.sick.com/UM30



Detailed technical data

Performance

| | |
|---------------------------------------|--|
| Working range, limiting range | 600 mm ... 6,000 mm, 8,000 mm |
| Resolution | ≥ 0.18 mm |
| Repeatability | ± 0.15 % ¹⁾ |
| Accuracy | ± 1 % ^{1) 2)} |
| Temperature compensation | ✓ |
| Response time | 240 ms |
| Output time | 60 ms |
| Ultrasonic frequency (typical) | 80 kHz |
| Detection area (typical) | See diagrams |
| Additional function | Teach-in of analog output, scaling of analog outputs, Invertable analog output, automatic selection of analog current or voltage output, temperature compensation, synchronization of up to 10 sensors, multiplexing: no cross talk of up to 10 sensors, set measurement filters: value filter, filter strength, adjustable sensitivity, foreground suppression and detection area, switch-off display, reset to factory default ³⁾ |

¹⁾ Referring to current measurement value.

²⁾ Temperature compensation can be switched off, without temperature compensation: 0.17 % / K.

³⁾ Functions may vary depending on sensor type.

Interfaces

| | |
|-----------------------------------|--|
| Analog output | 1 x 0 V ... 10 V (≥ 100 kΩ) ¹⁾ |
| | 1 x 4 mA ... 20 mA (≤ 500 Ω) ^{2) 1) 3)} |
| Resolution analog output | 12 bit |
| Multifunctional input (MF) | 1 x MF |

¹⁾ Automatic selection of analog current or voltage output dependent on load.

²⁾ For 4 mA ... 20 mA and $V_S \leq 20$ V max. load ≤ 100 Ω.

³⁾ Subsequent smoothing of the analog output, depending on the application, may increase the response time by up to 200 %.

Mechanics/electronics

| | |
|--|---|
| Supply voltage V_s | DC 9 V ... 30 V ^{1) 2)} |
| Power consumption | ≤ 2.4 W ³⁾ |
| Initialization time | < 300 ms |
| Design | Cylindrical |
| Housing material | Nickel-plated brass, PBT Display: TPU Ultrasonic transducer: polyurethane foam, glass epoxy resin |
| Connection type | Male connector, M12, 5-pin |
| Indication | LED display, 2 x LED |
| Weight | 270 g |
| Sending axis | Straight |

1) Limit values, reverse-polarity protected, operation in short-circuit protected network: max. 8 A.

2) 15 V ... 30 V when using the analog voltage output.

3) Without load.

Ambient data

| | |
|----------------------------|--|
| Enclosure rating | IP 67 |
| Protection class | III |
| Ambient temperature | Operation: -25 °C ... $+70$ °C Storage: -40 °C ... $+85$ °C |

Dimensional drawing (Dimensions in mm (inch))

UM30-215

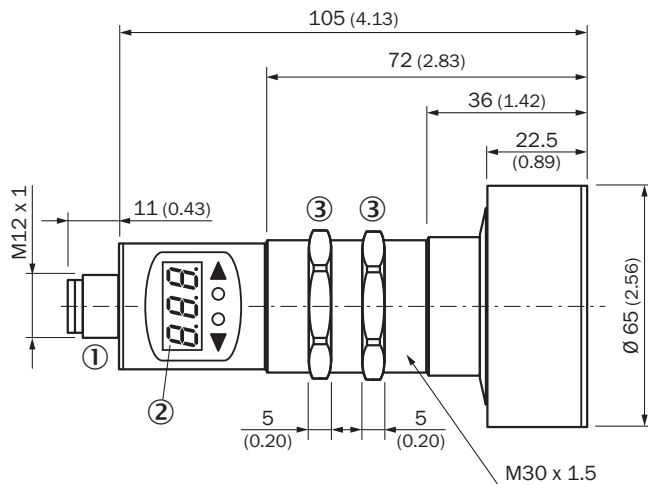

- ① Connection
- ② Display
- ③ Mounting nuts, SW 36 mm

Connection type

Male connector M12, 5-pin



Connection diagram

UM30-21x113 Connector M12, 5-pin

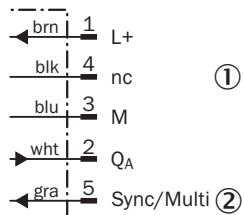

① Not assigned

② Synchronization and multiplex operation/communication Connect+

Adjustment possible

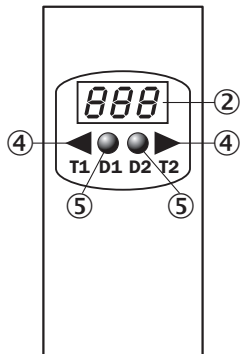

② Display

④ Operating elements

⑤ Status indicators

Detection area



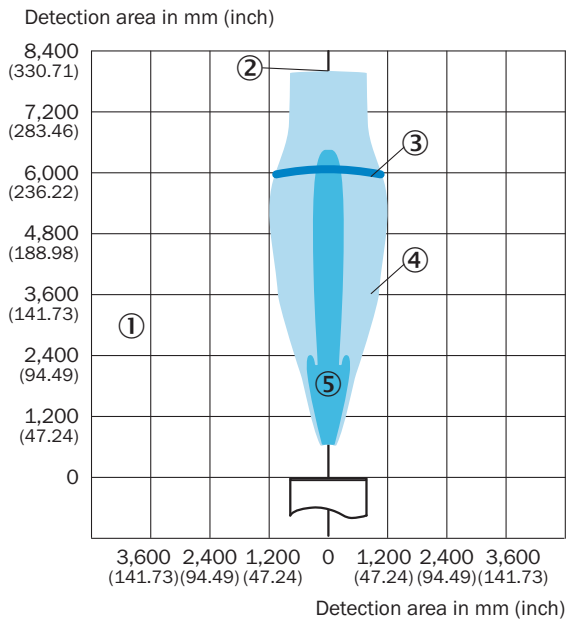

UM30-215, UC30-215





- ① Sensing range dependent on reflection properties, size and orientation of the object
- ② Limiting range
- ③ Working range
- ④ Example object: aligned plate 500 mm x 500 mm
- ⑤ Example object: pipe with 27 mm diameter

Recommended accessories

Other models and accessories → www.sick.com/UM30

| | Brief description | Type | Part no. |
|---|---|---------------|----------|
| Mounting brackets and mounting plates | | | |
|  | Mounting plate for M30 sensors, steel, zinc coated, without mounting hardware | BEF-WG-M30 | 5321871 |
|  | Mounting bracket, M30 thread, steel, zinc coated, without mounting hardware | BEF-WN-M30 | 5308445 |
| Terminal and alignment brackets | | | |
|  | Mounting bracket, M30, axial rotation possible, with threaded mounting hole M6, without mounting hardware | BEF-HA-M30A | 5311527 |
| Plug connectors and cables | | | |
|  | Head A: female connector, M12, 5-pin, straight Head B: cable Cable: PVC, unshielded, 2 m | DOL-1205-G02M | 6008899 |

| | Brief description | Type | Part no. |
|---|---|------------------------|----------|
|  | Head A: female connector, M12, 5-pin, angled Head B: cable Cable: PVC, unshielded, 2 m | DOL-1205-W02M | 6008900 |
| Programming and configuration tools | | | |
|  | Tool for visualization, configuration and cloning, 3-digit LED display, supply voltage: DV 9 V ... 30 V | Connect+ adapter (CPA) | 6037782 |

SICK AT A GLANCE

SICK is one of the leading manufacturers of intelligent sensors and sensor solutions for industrial applications. A unique range of products and services creates the perfect basis for controlling processes securely and efficiently, protecting individuals from accidents and preventing damage to the environment.

We have extensive experience in a wide range of industries and understand their processes and requirements. With intelligent sensors, we can deliver exactly what our customers need. In application centers in Europe, Asia and North America, system solutions are tested and optimized in accordance with customer specifications. All this makes us a reliable supplier and development partner.

Comprehensive services complete our offering: SICK LifeTime Services provide support throughout the machine life cycle and ensure safety and productivity.

For us, that is “Sensor Intelligence.”

WORLDWIDE PRESENCE:

Contacts and other locations –www.sick.com