

### FEATURES

**10-Bit, 18 MSPS A/D Converter**  
**18 MSPS Full-Speed CDS**  
**Low Noise, Wideband PGA**  
**Internal Voltage Reference**  
**No Missing Codes Guaranteed**  
**+3 V Single Supply Operation**  
**Low Power CMOS: 185 mW**  
**48-Pin TQFP Package**

# OBSOLETE

### PRODUCT DESCRIPTION

The AD9801 is a complete CCD signal processor developed for electronic cameras. It is well suited for both video conferencing and consumer level still camera applications.

The signal processing chain is comprised of a high speed CDS, variable gain PGA and 10-bit ADC. Required clamping circuitry and an onboard voltage reference are also provided. The AD9801 operates from a single +3 V supply with a typical power consumption of 185 mW.

The AD9801 is packaged in a space saving 48-pin thin-quad flatpack (TQFP) and is specified over an operating temperature range of 0°C to +70°C.

### FUNCTIONAL BLOCK DIAGRAM

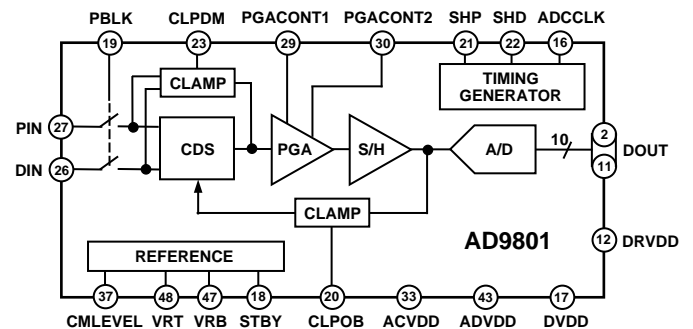

### PRODUCT HIGHLIGHTS

- On-Chip Input Clamp and CDS**  
 Clamp circuitry and high speed correlated double sampler allow for simple ac coupling to interface a CCD sensor at full 18 MSPS conversion rate.
- On-Chip PGA**  
 The AD9801 includes a low noise, wideband amplifier with analog variable gain from 0 dB to 31.5 dB (linear in dB).
- 10-Bit, High Speed A/D Converter**  
 A linear 10-bit ADC is capable of digitizing CCD signals at the full 18 MSPS conversion rate. (Typical DNL is  $\pm 0.5$  LSB and no missing code performance is guaranteed.)
- Low Power**  
 At 185 mW, the AD9801 consumes a fraction of the power of presently available multichip solutions. The part's power-down mode (15 mW) further enhances its desirability in low power, battery operated applications.
- Digital I/O Functionality**  
 The AD9801 offers three-state digital output control.
- Small Package**  
 Packaged in a 48-pin, surface-mount thin-quad flatpack, the AD9801 is well suited to very tight, low headroom designs.

REV. 0

Information furnished by Analog Devices is believed to be accurate and reliable. However, no responsibility is assumed by Analog Devices for its use, nor for any infringements of patents or other rights of third parties which may result from its use. No license is granted by implication or otherwise under any patent or patent rights of Analog Devices.

# AD9801—SPECIFICATIONS ( $T_{MIN}$ to $T_{MAX}$ with ACVDD = 3.15 V, ADVDD = 3.15 V, DVDD = 3.15 V, DRVDD = 3.15 V unless otherwise noted)

| Parameter   | Min  | Typ        | Max  | Units            |
|---|------|------------|------|------------------|
| <b>TEMPERATURE RANGE</b>  |      |            |      |                  |
| Operating   | 0    |            | 70   | °C               |
| Storage   | -65  |            | 150  | °C               |
| <b>POWER SUPPLY VOLTAGE</b><br>(For Functional Operation)                     |      |            |      |                  |
| ACVDD   | 3.00 | 3.15       | 3.50 | V                |
| ADVDD   | 3.00 | 3.15       | 3.50 | V                |
| DVDD  | 3.00 | 3.15       | 3.50 | V                |
| DRVDD   | 3.00 | 3.15       | 3.50 | V                |
| <b>POWER SUPPLY CURRENT</b>   |      |            |      |                  |
| ACVDD   |      | 39.5       |      | mA               |
| ADVDD   |      | 14.6       |      | mA               |
| DVDD  |      | 4.7        |      | mA               |
| DRVDD   |      | 0.07       |      | mA               |
| <b>POWER CONSUMPTION</b>  |      |            |      |                  |
| Normal Operation  |      | 185        |      | mW               |
| Power-Down Mode   |      | 15         |      | mW               |
| <b>MAXIMUM SHP, SHD, ADCCLK RATE</b>  |      |            |      |                  |
|   | 18   |            |      | MHz              |
| <b>ADC</b>  |      |            |      |                  |
| Resolution  | 10   |            |      | Bits             |
| Differential Nonlinearity   |      | ±0.5       |      | LSB              |
| No Missing Codes  |      | GUARANTEED |      |                  |
| ADCCLK Rate   |      | 18         |      | MHz              |
| Reference Top Voltage   |      | 1.75       |      | V                |
| Reference Bottom Voltage  |      | 1.25       |      | V                |
| Input Range   |      | 1.0        |      | V <sub>p-p</sub> |
| <b>CDS</b>  |      |            |      |                  |
| Maximum Input Signal  | 500  |            |      | mV p-p           |
| Pixel Rate  |      |            | 18   | MHz              |
| <b>PGA<sup>1</sup></b>  |      |            |      |                  |
| Maximum Gain  |      | 31.5       |      | dB               |
| High Gain   | 15   | 19         | 23   | dB               |
| Medium Gain   | 0.5  | 3.5        | 6.5  | dB               |
| Minimum Gain  | -5   | -1         | +3   | dB               |
| <b>CLAMP</b>  |      |            |      |                  |
| Average Black Level (During CLPOB. Only Stable Over PGA Range 0.3 V to 2.7 V) |      | 32         |      | LSB              |

<sup>1</sup>PGA test conditions: max gain PGACONT1 = 2.7 V, PGACONT2 = 1.5 V; high gain PGACONT1 = 2.0 V, PGACONT2 = 1.5 V; medium gain PGACONT1 = 0.5 V, PGACONT2 = 1.5 V; minimum gain PGACONT1 = 0.3 V, PGACONT2 = 1.5 V.

Specifications subject to change without notice.

## DIGITAL SPECIFICATIONS ( $T_{MIN}$ to $T_{MAX}$ with ACVDD = 3.15 V, ADVDD = 3.15 V, DVDD = 3.15 V, DRVDD = 3.15 V unless otherwise noted)

| Parameter                 | Symbol   | Min | Typ | Max | Units |
|---------------------------|----------|-----|-----|-----|-------|
| <b>LOGIC INPUTS</b>       |          |     |     |     |       |
| High Level Input Voltage  | $V_{IH}$ | 2.4 |     |     | V     |
| Low Level Input Voltage   | $V_{IL}$ |     |     | 0.6 | V     |
| High Level Input Current  | $I_{IH}$ |     | 10  |     | μA    |
| Low Level Input Current   | $I_{IL}$ |     | 10  |     | μA    |
| Input Capacitance         | $C_{IN}$ |     | 10  |     | pF    |
| <b>LOGIC OUTPUTS</b>      |          |     |     |     |       |
| High Level Output Voltage | $V_{OH}$ | 2.4 |     |     | V     |
| Low Level Output Voltage  | $V_{OL}$ |     |     | 0.6 | V     |
|                           | $I_{OH}$ |     | 50  |     | μA    |
|                           | $I_{OL}$ |     | 50  |     | μA    |

Specifications subject to change without notice.

**TIMING SPECIFICATIONS** ( $T_{\text{MIN}}$  to  $T_{\text{MAX}}$  with ACVDD = 3.15 V, ADVDD = 3.15 V, DVDD = 3.15 V, DRVDD = 3.15 V unless otherwise noted)

| Parameter                | Min  | Typ  | Max | Units |
|--------------------------|------|------|-----|-------|
| ADCCLK CLOCK PERIOD      | 55.6 |      |     | ns    |
| ADCCLK High Level Period | 24.8 | 27.8 |     | ns    |
| ADCCLK Low Level Period  | 24.8 | 27.8 |     | ns    |
| SHP, SHD Clock Period    | 55.6 |      |     | ns    |
| Digital Output Delay     |      | 20   |     | ns    |

**Digital Output Data Control**

| Mode1 | Mode2 | Digital Output Data (D9–D0)           |
|-------|-------|---------------------------------------|
| 0     | 0     | Normal Operation                      |
| 0     | 1     | 1   0   1   0   1   0   1   0   1   0 |
| 1     | 0     | 0   1   0   1   0   1   0   1   0   1 |
| 1     | 1     | High Impedance                        |

**ABSOLUTE MAXIMUM RATINGS\***

| Parameter                 | With Respect To | Min  | Max         | Units |
|---------------------------|-----------------|------|-------------|-------|
| ADVDD                     | ADVSS, SUBST    | -0.3 | 6.5         | V     |
| ACVDD                     | ACVSS, SUBST    | -0.3 | 6.5         | V     |
| DVDD                      | DVSS, DSUBST    | -0.3 | 6.5         | V     |
| DRVDD                     | DRVSS, DSUBST   | -0.3 | 6.5         | V     |
| SHP, SHD                  | DSUBST          | -0.3 | DVDD + 2.0  | V     |
| ADCCLK, CLOB, CLPDM       | DSUBST          | -0.3 | DVDD + 0.3  | V     |
| PGACONT1, PGACONT2        | SUBST           | -0.3 | ACVDD + 0.3 | V     |
| PIN, DIN                  | SUBST           | -0.3 | ACVDD + 0.3 | V     |
| DOUT                      | DSUBST          | -0.3 | DRVDD + 0.3 | V     |
| VRT, VRB                  | SUBST           | -0.3 | ADVDD + 0.3 | V     |
| CLAMP_BIAS                | SUBST           | -0.3 | ACVDD + 0.3 | V     |
| CCDBYP1, CCDBYP2          | SUBST           | -0.3 | ACVDD + 0.3 | V     |
| STBY                      | DSUBST          | -0.3 | DVDD + 0.3  | V     |
| MODE1, MODE2              | SUBST           | -0.3 | ADVDD + 0.3 | V     |
| DRVSS, DVSS, ACVSS, ADVSS | SUBST, DSUBST   | -0.3 | +0.3        | V     |
| Junction Temperature      |                 |      | +150        | °C    |
| Storage Temperature       |                 | -65  | +150        | °C    |
| Lead Temperature (10 sec) |                 |      | +300        | °C    |

\* Stresses above those listed under “Absolute Maximum Ratings” may cause permanent damage to the device. This is a stress rating only; functional operation of the device at these or other conditions above those indicated in the operational sections of this specification is not implied. Exposure to absolute maximum ratings for extended periods may affect device reliability.

**ORDERING GUIDE**

| Model  | Temperature  | Package Description | Package Option* |
|--------|--------------|---------------------|-----------------|
| AD9801 | 0°C to +70°C | 48-Pin TQFP         | ST-48           |

\*ST = Thin Quad Flatpack Package.

**CAUTION**

ESD (electrostatic discharge) sensitive device. Electrostatic charges as high as 4000 V readily accumulate on the human body and test equipment and can discharge without detection. Although the AD9801 features proprietary ESD protection circuitry, permanent damage may occur on devices subjected to high energy electrostatic discharges. Therefore, proper ESD precautions are recommended to avoid performance degradation or loss of functionality.



## PIN CONFIGURATION

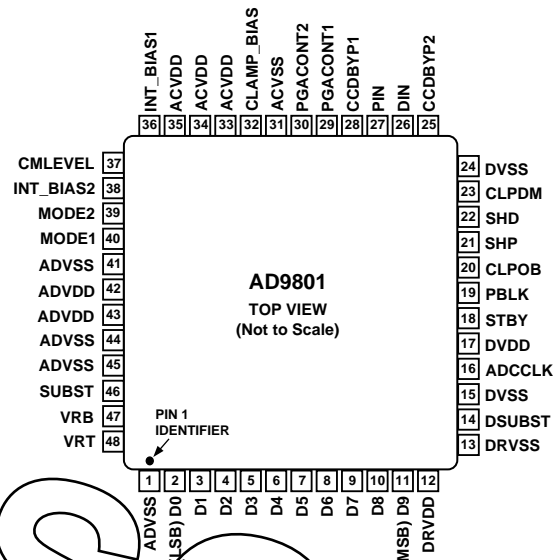

| Pin No. | Pin Name   | Type | Description   |
|---------|------------|------|---|
| 1       | ADVSS      | P    | Analog Ground   |
| 2–11    | D0–D9      | DO   | Digital Data Outputs  |
| 12      | DRVDD      | P    | +3 V Digital Driver Supply  |
| 13      | DRVSS      | P    | Digital Driver Ground   |
| 14      | DSUBST     | P    | Digital Substrate   |
| 15      | DVSS       | P    | Digital Ground  |
| 16      | ADCCLK     | DI   | ADC Sample Clock Input  |
| 17      | DVDD       | P    | +3 V Digital Supply   |
| 18      | STBY       | DI   | Power down (Active HIGH)  |
| 19      | PBLK       | DI   | Pixel Blanking (Active LOW)   |
| 20      | CLPOB      | DI   | Black Level Restore Clamp (Active LOW)  |
| 21      | SHP        | DI   | Reference Sample Clock Input  |
| 22      | SHD        | DI   | Data Sample Clock Input   |
| 23      | CLPDM      | DI   | Input Clamp (Active Low)  |
| 24      | DVSS       | DI   | Digital Ground  |
| 25      | CCDBYP2    | AO   | CCD Bypass (Decouple to Analog Ground Through 0.1 μF)                           |
| 26      | DIN        | AI   | CDS Input (Tie to Pin 27 and AC-Couple to CCD Output Through 0.1 μF)            |
| 27      | PIN        | AI   | CDS Input (See Above)   |
| 28      | CCDBYP1    | AO   | CCD Bypass (Decouple to Analog Ground Through 0.1 μF)                           |
| 29      | PGACONT1   | AI   | Coarse PGA Gain Control (0.3 V–2.7 V Decoupled to Analog Ground Through 0.1 μF) |
| 30      | PGACONT2   | AI   | Fine PGA Gain Control (0.3 V–2.7 V Decoupled to Analog Ground Through 0.1 μF)   |
| 31      | ACVSS      | P    | Analog Ground   |
| 32      | CLAMP_BIAS | AO   | Clamp Bias Level (Decouple to Analog Ground Through 0.1 μF)                     |
| 33      | ACVDD      | P    | +3 V Analog Supply  |
| 34      | ACVDD      | AI   | +3 V Analog Supply  |
| 35      | ACVDD      | AI   | +3 V Analog Supply  |
| 36      | INT_BIAS1  | AO   | Internal Bias Level (Decouple to Analog Ground Through 0.1 μF)                  |
| 37      | CMLEVEL    | AO   | Common-Mode Level (Decouple to Analog Ground Through 0.1 μF)                    |
| 38      | INT_BIAS2  | AO   | Internal Bias Level (Decouple to Analog Ground Through 0.1 μF)                  |
| 39      | MODE2      | DI   | ADC Test Mode Control (See Digital Output Data Control)                         |
| 40      | MODE1      | DI   | ADC Test Mode Control (See Digital Output Data Control)                         |
| 41      | ADVSS      | P    | Analog Ground   |
| 42      | ADVDD      | P    | +3 V Analog Supply  |
| 43      | ADVDD      | P    | +3 V Analog Supply  |
| 44      | ADVSS      | P    | Analog Ground   |
| 45      | ADVSS      | P    | Analog Ground   |
| 46      | SUBST      | P    | Substrate (Connect to Analog Ground)  |
| 47      | VRB        | AO   | Bottom Reference Bypass (Decouple to Analog Ground Through 0.1 μF)              |
| 48      | VRT        | AO   | Top Reference Bypass (Decouple to Analog Ground Through 0.1 μF)                 |

EQUIVALENT INPUT CIRCUITS

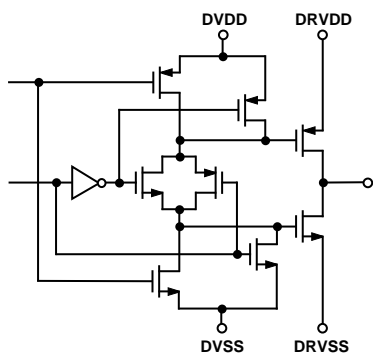

Figure 1. Pins 2-11 (DB0-DB9)

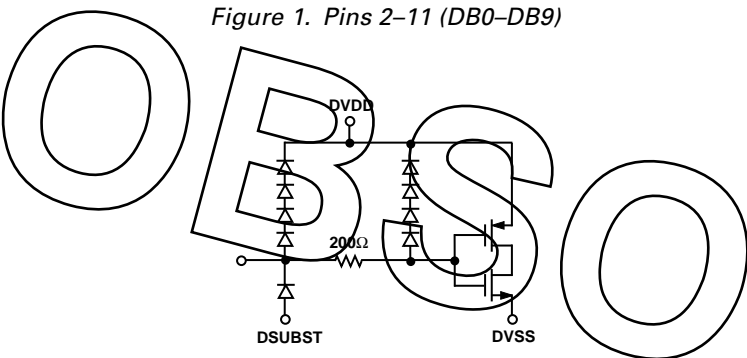

Figure 2. Pin 21 (SHP) and Pin 22 (SHD)

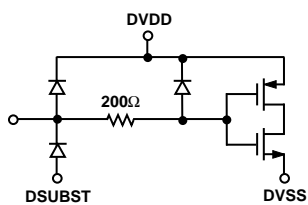

Figure 3. Pin 16 (ADCCLK)

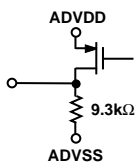

Figure 4. Pin 37 (CMLEVEL)

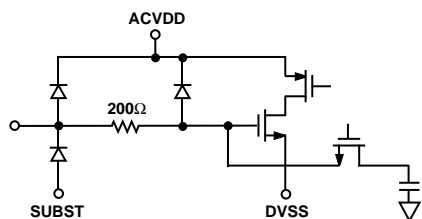

Figure 5. Pin 25 (CCDBYP2) and Pin 28 (CCDBYP1)

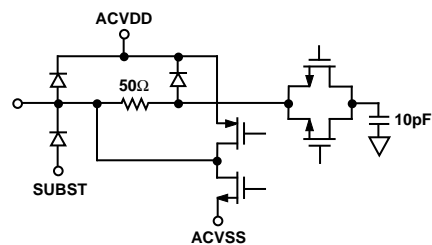

Figure 6. Pin 26 (DIN) and Pin 27 (PIN)

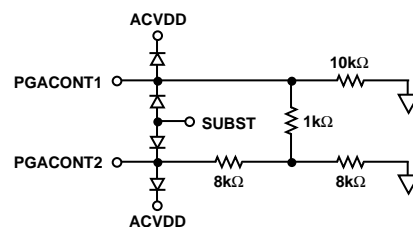

Figure 7. Pin 29 (PGACONT1) and Pin 30 (PGACONT2)

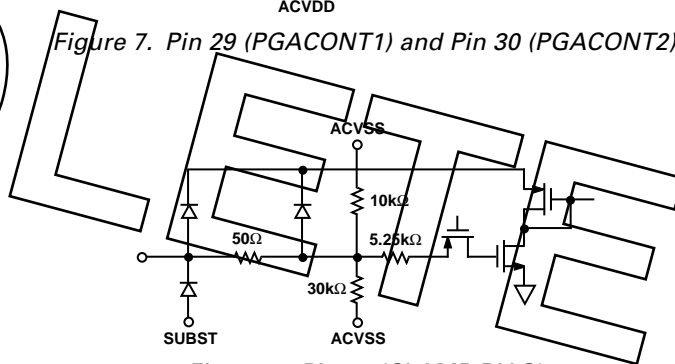

Figure 8. Pin 32 (CLAMP BIAS)

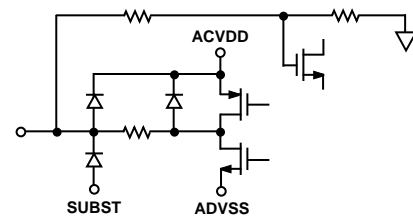
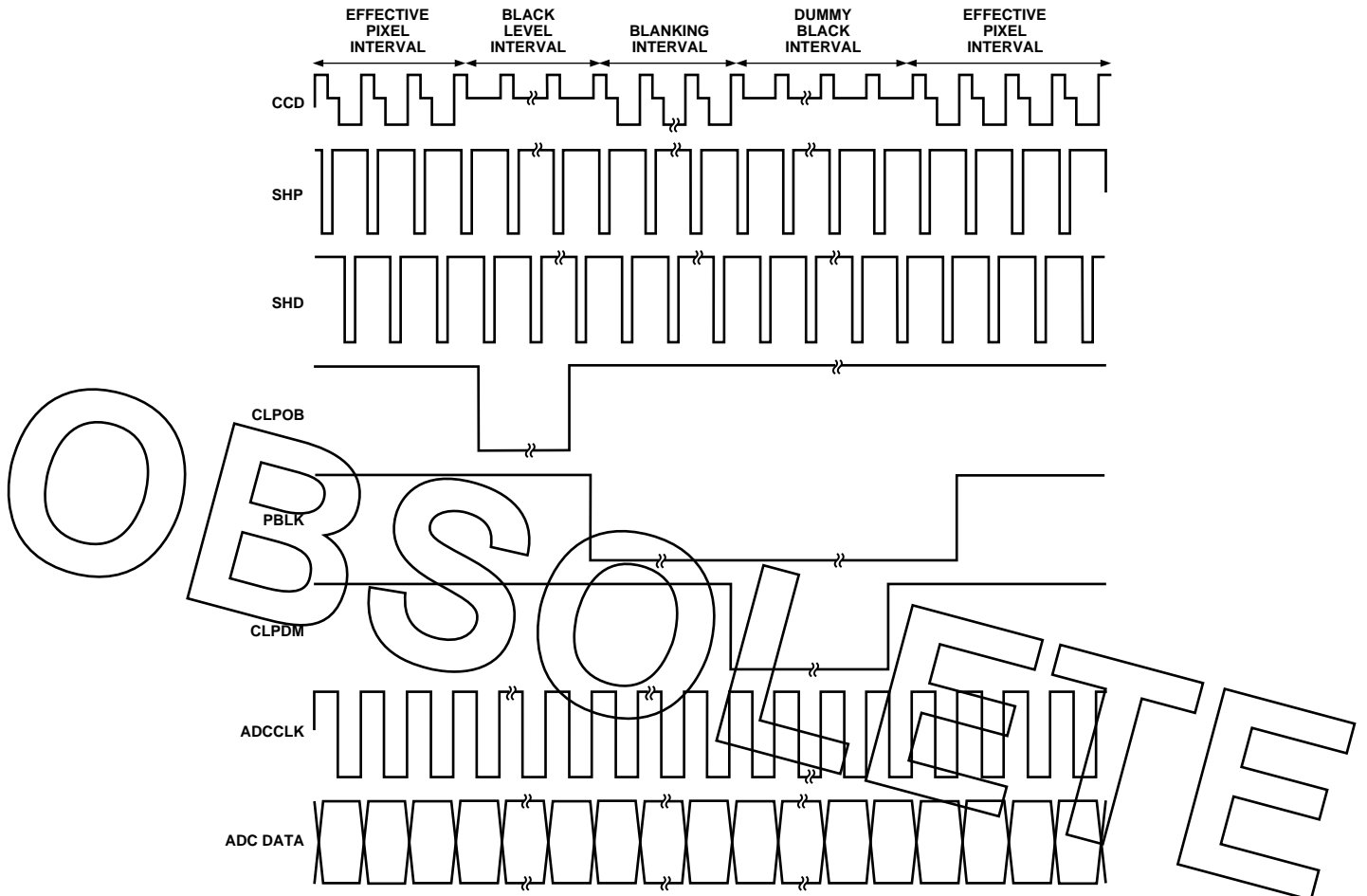
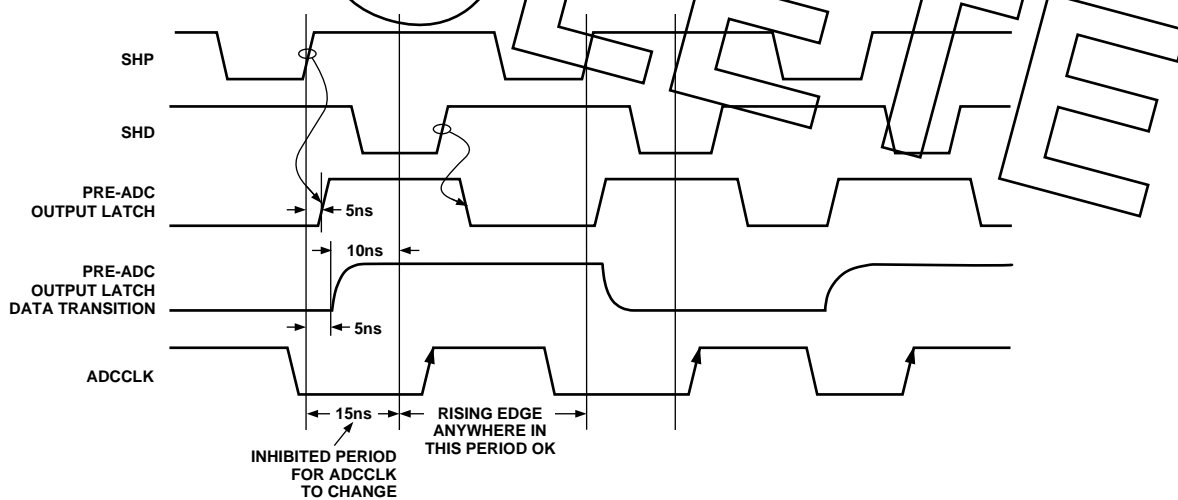
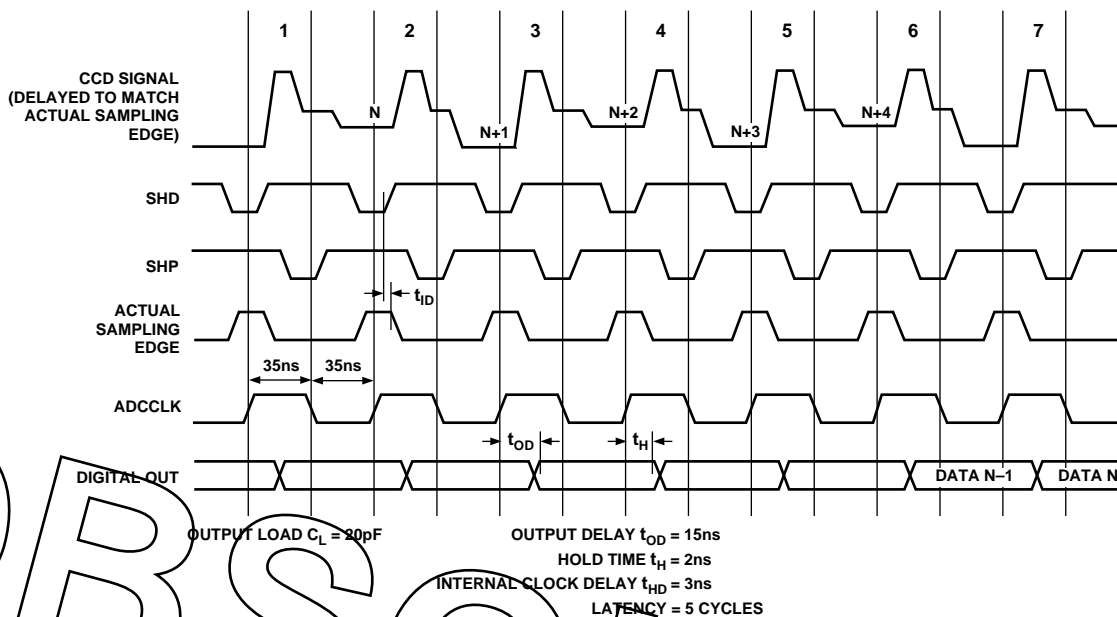

Figure 9. Pin 48 (VRT) and Pin 47 (VRB)



NOTE:  
 CLPDM OVERWRITES PBLK  
 CLAMP TIMING NEEDS TO BE ADJUSTED RELATIVE TO CCD'S BLACK PIXELS

Figure 10. Typical Horizontal Interval Timing



# AD9801

## THEORY OF OPERATION

### Introduction

The AD9801 is a 10-bit analog-to-digital interface for CCD cameras. The block level diagram of the system is shown in Figure 13. The device includes a correlated double sampler (CDS), 0 dB–31 dB variable gain amplifier (PGA), black level correction loop, input clamp and voltage reference. The only external analog circuitry required at the system level is an emitter follower buffer between the CCD output and AD9801 inputs.

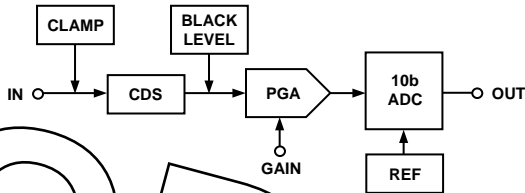

Figure 13.

### Correlated Double Sampling (CDS)

CDS is important in high performance CCD systems as a method for removing several types of noise. Basically, two samples of the CCD output are taken: one with the signal present (“data”) and one without (“reference”). Subtracting these two samples removes any noise that is common—or correlated—to both.

Figure 14 shows the block diagram of the AD9801’s CDS. The S/H blocks are directly driven by the input and the sampling function is performed passively, without the use of amplifiers.

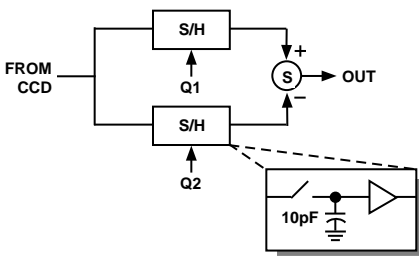

Figure 14.

This implementation relies on the off-chip emitter follower buffer to drive the two 10 pF sampling capacitors. Only one capacitor at a time is seen at the input pin.

The AD9801 actually uses two CDS circuits in a “ping pong” fashion to allow the system more acquisition time. In this way, the output from one of the two CDS blocks will be valid for an entire clock cycle. Thus, the bandwidth requirement of the subsequent gain stage is reduced as compared to that for a single CDS channel system. This lower bandwidth translates to lower power and noise.

### Programmable Gain Amplifier (PGA)

The on-chip PGA provides a (linear in dB) gain range of 0 dB–31.5 dB. A typical gain characteristic plot is shown in Figure 15. Only the range from 0.3 V to 2.7 V is intended for actual use.

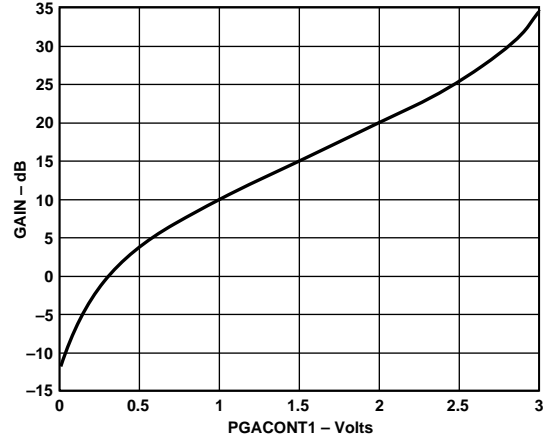

Figure 15.

As shown in Figure 16, PGA control is provided through the PGACONT1 and PGACONT2 inputs. PGACONT1 provides coarse and PGACONT2 fine (1/16) gain control.

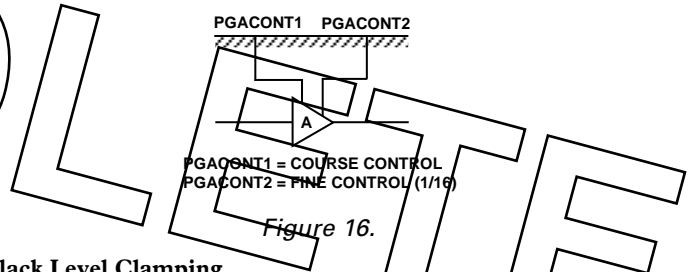

Figure 16.

### Black Level Clamping

For correct processing, the CCD signal must be referenced to a well established “black level” by the AD9801. At the edge of the CCD, there is a collection of pixels that are covered with metal to prevent any light penetration. As the CCD is read out, these “black pixels” provide a calibration signal that is used to establish the black level.

The feedback loop shown in Figure 17 is closed around the PGA during the calibration interval (CLPOB = LOW) to set the black level. As the black pixels are being processed, an integrator block measures the difference between the input level and the desired reference level. This difference, or error, signal is amplified and passed to the CDS block where it is added to the incoming pixel data. As a result of this process, the black pixels are digitized at one end of the ADC range, taking maximum advantage of the available linear range of the system.

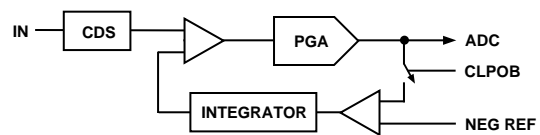

Figure 17.



The actual implementation of this loop is slightly more complicated as shown in Figure 18. Because there are two separate CDS blocks, two black level feedback loops are required and two offset voltages are developed. Figure 18 also shows an additional PGA block in the feedback loop labeled "RPGA."

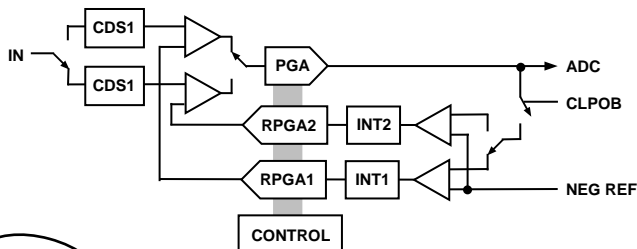

Figure 18.

The RPGA uses the same control inputs as the PGA, but has the inverse gain. The RPGA functions to attenuate by the same factor as the PGA amplifies, keeping the gain and bandwidth of the loop constant.

### Input Bias Level Clamping

The buffered CCD output is connected to the AD9801 through an external coupling capacitor. The dc bias point for this coupling capacitor is established during the clamping (CLPDM = LOW) period using the "dummy clamp" loop shown in Figure 19. When closed around the CDS, this loop establishes the desired DC bias point on the coupling capacitor.

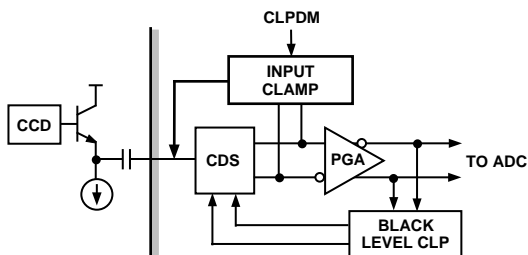

Figure 19.

### Input Blanking

In some applications, the AD9801's input may be exposed to large signals from the CCD. These signals can be very large, relative to the AD9801's input range, and could thus saturate on-chip circuit blocks. Recovery time from such saturation conditions could be substantial.

To avoid problems associated with processing these transients, the AD9801 includes an input blanking function. When active (PBLK = LOW), this function stops the CDS operation and allows the user to disconnect the CDS inputs from the CCD buffer.

If the input voltage exceeds the supply rail by more than 0.3 V, protection diodes will be turned on, increasing current flow into the AD9801 (see Equivalent Input Circuits). Such voltage levels should be externally clamped to prevent device damage or reliability degradation.

### 10-Bit Analog-to-Digital Converter (ADC)

The ADC employs a multibit pipelined architecture, which is well-suited for high throughput rates while being both area and power efficient. The multistep pipeline presents a low input capacitance resulting in lower on-chip drive requirements. A fully differential implementation was used to overcome headroom constraints of the single +3 V power supply.

### Differential Reference

The AD9801 includes a 0.5 V reference based on a differential, continuous-time bandgap cell. Use of an external bypass capacitor reduces the reference drive requirements, thus lowering the power dissipation. The differential architecture was chosen for its ability to reject supply and substrate noise. Recommended decoupling shown in Figure 20.

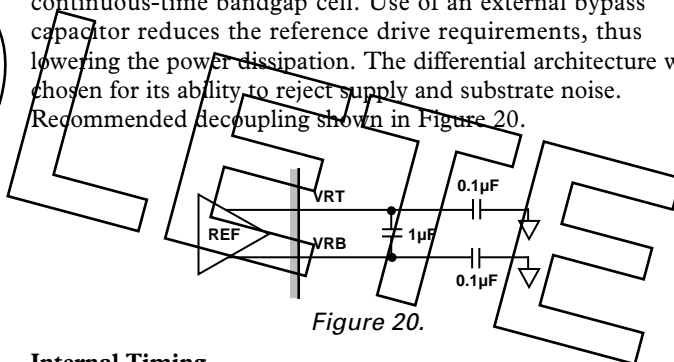

Figure 20.

### Internal Timing

The AD9801's on-chip timing circuitry generates all clocks necessary for operation of the CDS and ADC blocks. The user needs only to synchronize the SHP and SHD clocks with the CCD waveform, as all other timing is handled internally. The ADCCLK signal is used to strobe the output data, and can be adjusted to accommodate desired timing.

# AD9801

## APPLICATION INFORMATION

### Generating Clock Signals

For best performance, the AD9801 should be driven by 3 V logic levels. As shown in the Equivalent Input Circuits, the use of 5 V logic for ADCCLK will turn on the protection diode to DVDD, increasing the current flow into this pin. As a result, noise and power dissipation will increase. The CDS clock inputs, SHP and SHD, have additional protection and can withstand direct 5 V levels.

External clamping diodes or resistor dividers can be used to translate 5 V levels to 3 V levels, but the lowest power dissipation is achieved with a logic transceiver chip. National Semiconductor's 74LVX4245 provides a 5 V to 3 V level shift for up to eight clock signals, and features a three-state option and low power consumption. Philips Semiconductor and Quality also manufacture similar devices.

### Digitally Programmable Gain Control

The AD9801's PGA is controlled by an analog input voltage of 0.3 V to 2.7 V. In some applications, digital gain control is preferable. Figure 21 shows a circuit using Analog Devices' AD8402 Digital Potentiometer to generate the PGA control voltage. The AD8402 functions as two individual potentiometers, with a serial digital interface to program the position of each wiper over 256 positions. The device will operate with 3 V or 5 V supplies, and features a power-down mode and a reset function.

To keep external components to a minimum, the ends of the "potentiometers" can be tied to ground and +3 V. One pot is used for the coarse gain adjust, PGACONT1, with steps of about 0.2 dB/LSB. The other pot is used for fine gain control, PGACONT2, and is capable of around 0.01 dB steps if all eight bits are used. The two outputs should be filtered with 1  $\mu$ F or larger capacitors to minimize noise into the PGACONT pins of the AD9801.

The disadvantage of this circuit is that the control voltage will be supply dependent. If additional precision is required, an external op amp can be used to amplify the VREFT (1.75 V) or VREFB (1.25 V) pins on the AD9801 to the desired voltage level. These reference voltages are stable over the operating supply range of the AD9801. Low power, low cost, rail-to-rail output amplifiers such as the AD820, OP150 and OP196 are specified for 3 V operation. Alternatively, a precision voltage

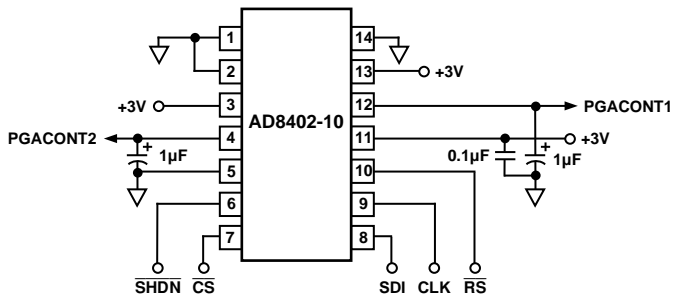

Figure 21. Digital Control of PGA

reference may be used. The REF193 from Analog Devices features low power, low dropout performance, maintaining a 3 V output with a minimum 3.1 V supply when lightly loaded.

### Power and Grounding Recommendations

The AD9801 should be treated as an analog component when used in a system. The same power supply and ground plane should be used for all of the pins. In a two-ground system, this requires that the digital supply pins be decoupled to the analog ground plane and the digital ground pins be connected to analog ground for best noise performance. If any pins on the AD9801 are connected to the system digital ground, noise can capacitively couple inside the AD9801 (through package and die parasitics) from the digital circuitry to the analog circuitry. Separate digital supplies can be used, particularly if slightly different driver supplies are needed, but the digital power pins should still be decoupled to the same point as the digital ground pins (analog ground plane). If the AD9801 digital outputs need to drive a bus or substantial load, a buffer should be used at the AD9801's outputs, with the buffer referenced to system digital ground. In some cases, when system digital noise is not substantial, it is acceptable to split the ground pins on the AD9801 to separate analog and digital ground planes. If this is done, be sure to connect the ground pins together at the AD9801.

To further improve performance, isolating the driver supply DRVDD from DVDD with a ferrite bead can help reduce kickback effects during major code transitions. Alternatively, the use of damping resistors on the digital outputs will reduce the output risetimes, reducing the kickback effect.

## EVALUATION BOARD

Figure 22 shows the schematic for the AD9801 evaluation board. Notice the use of a common ground and supply for the AD9801, and the extensive supply and reference decoupling.

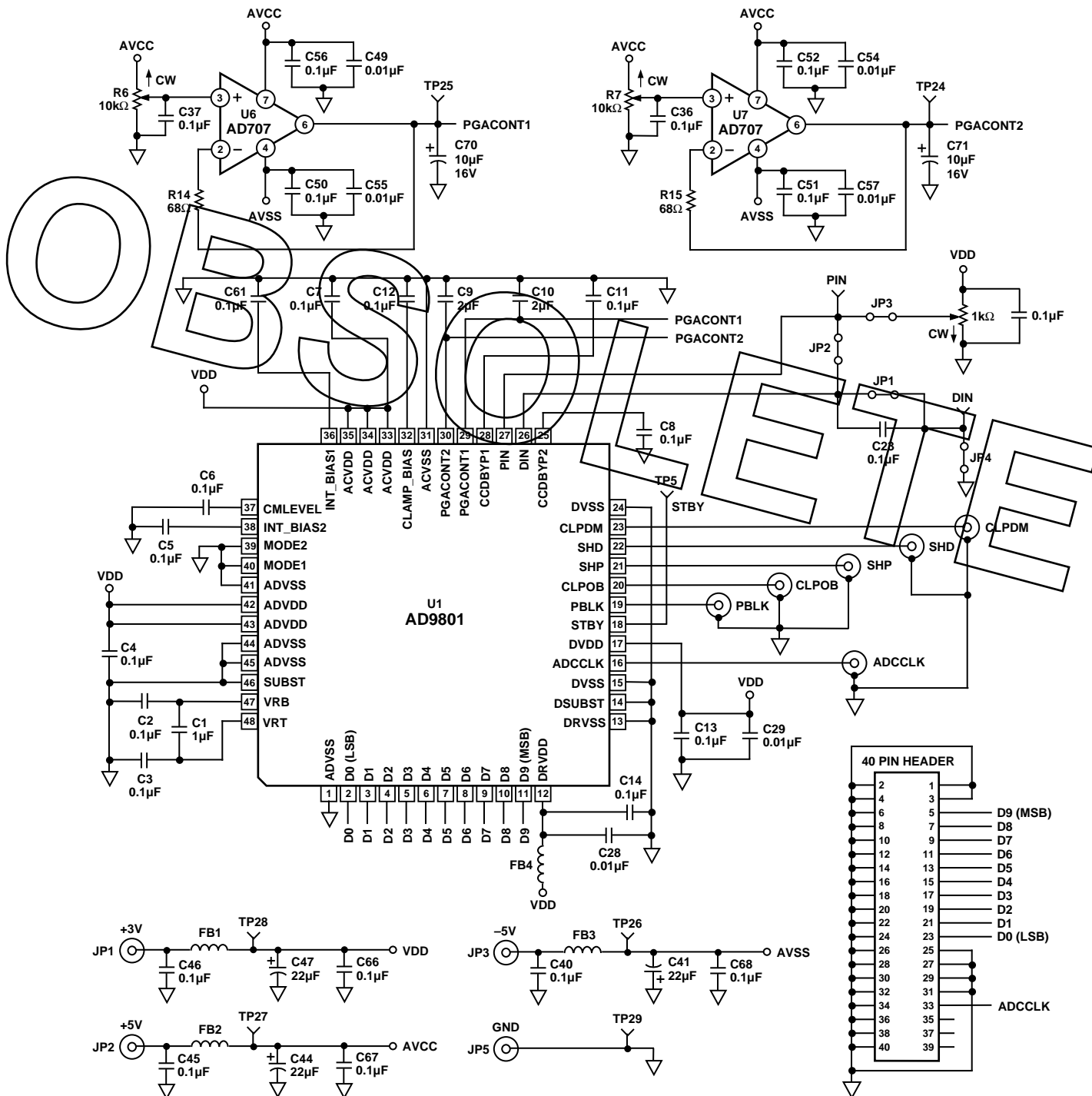
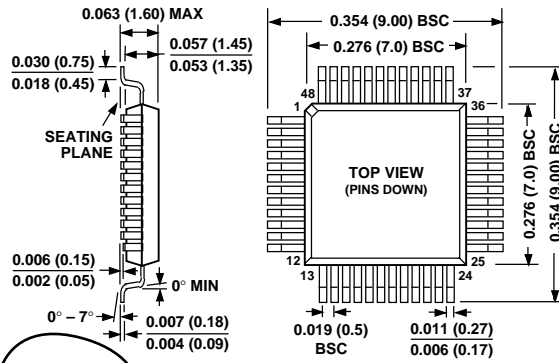

Figure 22. AD9801EB Schematic

OUTLINE DIMENSIONS

Dimensions shown in inches and (mm).

48-Terminal Plastic Thin Quad Flatpack  
(ST-48)



OBSOLETE