

### FEATURES

- Ultralow rms jitter: 44 fs typical (12 kHz to 20 MHz) at 2457.6 MHz
- Noise floor: -156 dBc/Hz at 2457.6 MHz
- Low phase noise: -141.7 dBc/Hz at 800 kHz, 983.04 MHz output
- Up to 14 LVDS, LVPECL, or CML type device clocks (DCLKs) from PLL2
- Maximum CLKOUTx/CLKOUTx and SCLKOUTx/SCLKOUTx frequency up to 3200 MHz
- JESD204B-compatible system reference (SYSREF) pulses 25 ps analog, and 1/2 VCO cycle digital delay independently programmable on each of 14 clock output channels
- SPI-programmable phase noise vs. power consumption
- SYSREF valid interrupt to simplify JESD204B synchronization
- Narrow-band, dual core VCOs
- Up to 2 buffered voltage controlled oscillator (VCXO) outputs
- Up to 4 input clocks in LVDS, LVPECL, CMOS, and CML modes
- Frequency holdover mode to maintain output frequency
- Loss of signal (LOS) detection and hitless reference switching
- 4x GPIOs alarms/status indicators to determine the health of the system
- External VCO input to support up to 6000 MHz
- On-board regulators for excellent PSRR
- 68-lead, 10 mm x 10 mm LFCSP package

### APPLICATIONS

- JESD204B clock generation
- Cellular infrastructure (multicarrier GSM, LTE, W-CDMA)
- Data converter clocking
- Microwave baseband cards
- Phase array reference distribution

### GENERAL DESCRIPTION

The HMC7044 is a high performance, dual-loop, integer-N jitter attenuator capable of performing reference selection and generation of ultralow phase noise frequencies for high speed data converters with either parallel or serial (JESD204B type) interfaces. The HMC7044 features two integer mode PLLs and overlapping on-chip VCOs that are SPI-selectable with wide tuning ranges around 2.5 GHz and 3 GHz, respectively. The device is designed to meet the requirements of GSM and LTE base station designs, and offers a wide range of clock management and distribution features to simplify baseband and radio card clock tree designs. The HMC7044 provides 14 low noise and configurable outputs to offer flexibility in interfacing with many different components including data converters, field-programmable gate arrays (FPGAs), and mixer local oscillators (LOs).

The DCLK and SYSREF clock outputs of the HMC7044 can be configured to support signaling standards, such as CML, LVDS, LVPECL, and LVCMOS, and different bias settings to offset varying board insertion losses.

### FUNCTIONAL BLOCK DIAGRAM

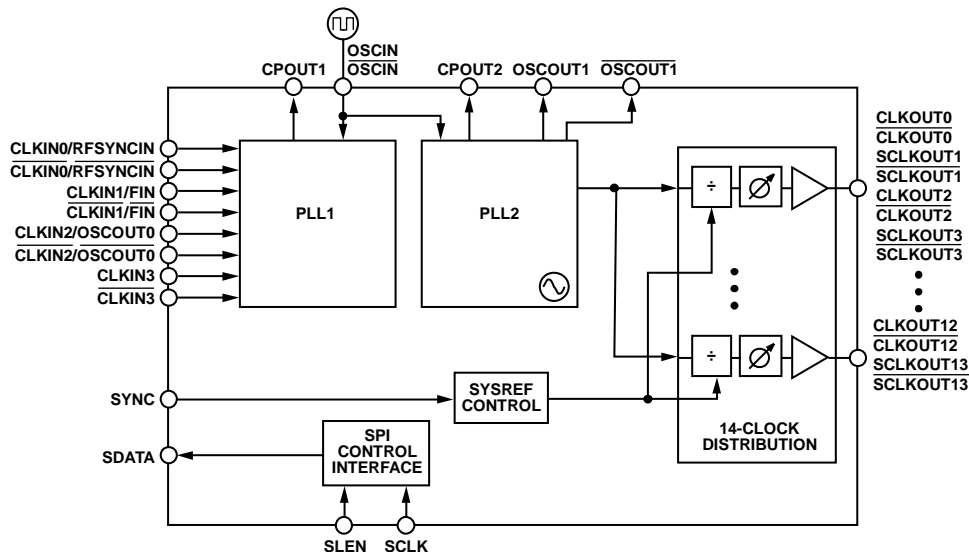

Figure 1.

Rev. B

[Document Feedback](#)

Information furnished by Analog Devices is believed to be accurate and reliable. However, no responsibility is assumed by Analog Devices for its use, nor for any infringements of patents or other rights of third parties that may result from its use. Specifications subject to change without notice. No license is granted by implication or otherwise under any patent or patent rights of Analog Devices. Trademarks and registered trademarks are the property of their respective owners.

## TABLE OF CONTENTS

Features .....	1	Theory of Operation .....	23
Applications.....	1	Detailed Block Diagram .....	24
General Description .....	1	Dual PLL Overview.....	25
Functional Block Diagram .....	1	Component Blocks—Input PLL (PLL1).....	25
Table of Contents .....	2	Component Blocks—Output PLL (PLL2) .....	30
Revision History .....	2	Clock Output Network .....	31
Specifications.....	3	Reference Buffer Details .....	38
Conditions.....	3	Typical Programming Sequence.....	38
Supply Current.....	3	Power Supply Considerations.....	39
Digital Input/Output (I/O) Electrical Specifications.....	4	Serial Control Port .....	42
PLL1 Characteristics .....	5	Serial Port Interface (SPI) Control.....	42
PLL2 Characteristics .....	7	Applications Information .....	43
VCO Characteristics .....	8	PLL1 Noise Calculations .....	43
Clock Output Distribution Characteristics.....	9	PLL2 Noise Calculations .....	43
Spur Characteristics .....	10	Phase Noise Floor and Jitter.....	43
Noise and Jitter Characteristics .....	10	Control Registers .....	44
Clock Output Driver Characteristics.....	11	Control Register Map .....	44
Absolute Maximum Ratings.....	13	Control Register Map Bit Descriptions .....	52
ESD Caution.....	13	Evaluation PCB Schematic .....	69
Pin Configuration and Function Descriptions.....	14	Evaluation PCB.....	69
Typical Performance Characteristics .....	17	Outline Dimensions .....	71
Typical Application Circuits.....	21	Ordering Guide .....	71
Terminology .....	22		

## REVISION HISTORY

### 11/2016—Rev. A to Rev. B

Changes to Table 1 and Endnote 4, Table 2.....	3
Changes to Reliable Signal Swing Parameter, Table 4.....	5
Change to PLL2 VCXO Input Parameter, Table 5.....	7
Changes to Table 7.....	9
Added Figure 13; Renumbered Sequentially .....	18
Added Figure 20.....	19
Added Figure 21, Figure 22, and Figure 23 .....	20
Changes to Figure 34.....	21
Changes to Table 15 and Table 17 .....	34
Changes to Figure 47 .....	37
Changes to Table 23.....	41
Changes to Table 25.....	46
Changes to Table 49.....	57
Change to Table 75 .....	68

### 5/2016—Rev. 0 to Rev. A

Changes to Table 3.....	4
Changes to Current Range (ICP2) Parameter, Table 5 .....	8
Changes to Table 9.....	11
Changes to Table 10 .....	13
Changes to LDOBYP5 Pin Description .....	15
Changes to Figure 13.....	19
Changes to Figure 30.....	25
Changes to Evaluation PCB Section .....	69
Added Figure 46; Renumbered Sequentially .....	69
Added Figure 50 .....	71
Updated Outline Dimensions .....	71

### 9/2015—Revision 0: Initial Version

## SPECIFICATIONS

Unless otherwise noted,  $f_{VCO} = 122.88$  MHz single-ended;  $\overline{CLKIN0/CLKIN0}$ ,  $\overline{CLKIN1/CLKIN1}$ ,  $\overline{CLKIN2/CLKIN2}$ , and  $\overline{CLKIN3/CLKIN3}$  differential at 122.88 MHz;  $f_{VCO} = 2949.12$  MHz; doubler is on; typical value is given for  $V_{CC} = 3.3$  V; and  $T_A = 25^\circ\text{C}$ . Minimum and maximum values are given over the full  $V_{CC}$  and  $T_A$  ( $-40^\circ\text{C}$  to  $+85^\circ\text{C}$ ) variation, as listed in Table 1. Note that multifunction pins, such as  $\overline{CLKIN0/RFSYNCIN}$ , are referred to either by the entire pin name or by a single function of the pin, for example,  $\overline{CLKIN0}$ , when only that function is relevant.

## CONDITIONS

Table 1.

Parameter	Min	Typ	Max	Unit	Test Conditions/Comments
SUPPLY VOLTAGE, $V_{CC}$					
VCC1_VCO	3.135	3.3	3.465	V	$3.3\text{ V} \pm 5\%$ , supply voltage for VCO and VCO distribution
VCC2_OUT	3.135	3.3	3.465	V	$3.3\text{ V} \pm 5\%$ , supply voltage for Output Channel 2 and Output Channel 3
VCC3_SYSREF	3.135	3.3	3.465	V	$3.3\text{ V} \pm 5\%$ , supply voltage for common SYSREF divider
VCC4_OUT	3.135	3.3	3.465	V	$3.3\text{ V} \pm 5\%$ , supply voltage for Output Channel 4, Output Channel 5, Output Channel 6, Output Channel 7
VCC5_PLL1	3.135	3.3	3.465	V	$3.3\text{ V} \pm 5\%$ , supply voltage for the LDO used in PLL1
VCC6_OSCOUT	3.135	3.3	3.465	V	$3.3\text{ V} \pm 5\%$ , supply voltage for oscillator output path
VCC7_PLL2	3.135	3.3	3.465	V	$3.3\text{ V} \pm 5\%$ , supply voltage for the LDO used in PLL2
VCC8_OUT	3.135	3.3	3.465	V	$3.3\text{ V} \pm 5\%$ , supply voltage for Output Channel 8, Output Channel 9, Output Channel 10, and Output Channel 11
VCC9_OUT	3.135	3.3	3.465	V	$3.3\text{ V} \pm 5\%$ , supply voltage for Output Channel 0, Output Channel 1, Output Channel 12, and Output Channel 13
TEMPERATURE					
Ambient Temperature Range, $T_A$	-40	+25	+85	$^\circ\text{C}$	

## SUPPLY CURRENT

For detailed test conditions, see Table 22 and Table 23.

Table 2.

Parameter <sup>1,2</sup>	Min	Typ	Max	Unit	Test Conditions/Comments
CURRENT CONSUMPTION <sup>3</sup>					
VCC1_VCO		157	225	mA	
VCC2_OUT <sup>4</sup>		65	250	mA	Typical value is given at $T_A = 25^\circ\text{C}$ with two LVDS clocks at divide by 8
VCC3_SYSREF		12	37	mA	
VCC4_OUT <sup>4</sup>		78	500	mA	Typical value is given at $25^\circ\text{C}$ with two LVPECL high performance clocks, fundamental frequency of internal VCO ( $f_0$ ), 2 SYSREF clocks (off)
VCC5_PLL1		39	125	mA	
VCC6_OSCOUT		0	80	mA	
VCC7_PLL2		46	80	mA	
VCC8_OUT <sup>4</sup>		124	500	mA	Typical value is given at $25^\circ\text{C}$ with two LVPECL high performance clocks at divide by 2, 2 SYSREF clocks (off)
VCC9_OUT <sup>4</sup>		65	500	mA	Typical value is given at $25^\circ\text{C}$ with two LVDS clocks at divide by 8, 2 SYSREF clocks (off)
Total Current		586		mA	

<sup>1</sup>Maximum values are guaranteed by design and characterization.

<sup>2</sup>Currents include LVPECL termination currents.

<sup>3</sup>Maximum values are for all circuits enabled in their worst case power consumption mode, PVT variations, and accounting for peak current draw during temporary synchronization events.

<sup>4</sup>Typical specification applies to a normal usage profile (Profile 1 in Table 23), where PLL1 and PLL2 are locked, but very low duty cycle currents (sync events) and some optional features are disabled. This specification assumes output configurations as described in the test conditions/comments column.

## DIGITAL INPUT/OUTPUT (I/O) ELECTRICAL SPECIFICATIONS

Table 3.

Parameter	Min	Typ	Max	Unit	Test Conditions/Comments
DIGITAL INPUT SIGNALS (RESET, SYNC, SLEN, SCLK)					
Safe Input Voltage Range <sup>1</sup>	-0.1		+3.6	V	
Input Load		0.3		pF	
Input Voltage					
Input Logic High (V <sub>IH</sub> )	1.2		V <sub>CC</sub>	V	
Input Logic Low (V <sub>IL</sub> )	0		0.5	V	
SPI Bus Frequency			10	MHz	
DIGITAL BIDIRECTIONAL SIGNALS CONFIGURED AS INPUTS (SDATA, GPIO4, GPIO3, GPIO2, GPIO1)					
Safe Input Voltage Range <sup>1</sup>	-0.1		+3.6	V	
Input Capacitance		0.4		pF	
Input Resistance		50G		Ω	
Input Voltage					
Input Logic High (V <sub>IH</sub> )	1.22		V <sub>CC</sub>	V	
Input Logic Low (V <sub>IL</sub> )	0		0.24	V	
Input Hysteresis		0.2		V	Occurs around 0.85 V
GPIO1 TO GPIO4 ALARM MUXING/DELAY					
Delay from Internal Alarm/Signal to General-Purpose Output (GPO) Driver		2		ns	Does not include t <sub>DGPO</sub>
DIGITAL BIDIRECTIONAL SIGNALS CONFIGURED AS OUTPUTS (SDATA, GPIO4, GPIO3, GPIO2, GPIO1)					
CMOS MODE					
Logic 1 Level	1.6	1.9	2.2	V	
Logic 0 Level		0	0.1	V	
Output Drive Resistance (R <sub>DRIVE</sub> )		50		Ω	
Output Driver Delay (t <sub>DGPO</sub> )		1.5 + 42 × C <sub>LOAD</sub>		ns	Approximately 1.5 ns + 0.69 × R <sub>DRIVE</sub> × C <sub>LOAD</sub> (C <sub>LOAD</sub> in nF)
Maximum Supported DC Current <sup>1</sup>			0.6	mA	
OPEN-DRAIN MODE <sup>1</sup>					
Logic 1 Level			3.6	V	External 1 kΩ pull-up resistor 3.6 V maximum permitted; specifications set by external supply
Logic 0 Level		0.13	0.28	V	Against a 1 kΩ external pull-up resistor to 3.3 V
Pull-Down Impedance		60		Ω	
Maximum Supported Sink Current			5	mA	

<sup>1</sup> Guaranteed by design and characterization.

## PLL1 CHARACTERISTICS

Table 4.

Parameter	Min	Typ	Max	Unit	Test Conditions/Comments
PLL1 REFERENCE INPUTS (CLKIN0/ $\overline{\text{CLKIN0}}$ , CLKIN1/ $\overline{\text{CLKIN1}}$ , CLKIN2/ $\overline{\text{CLKIN2}}$ , CLKIN3/ $\overline{\text{CLKIN3}}$ )					
Reliable Signal Swing					
Differential	0.375		1.4	V p-p	Differential, keep signal at reference input pin <2.8 V, measured at 800 MHz
Single-Ended <sup>1</sup>	0.375		1.4	V p-p	<250 MHz; keep signal at reference input pin <2.8 V
Common-Mode Range	0.4		2.4	V	If user supplied, on-chip $V_{\text{CM}}$ is approximately 2.1 V
Input Impedance		100 to 2000		$\Omega$	User selectable; differential
Return Loss		-12		dB	When terminated with 100 $\Omega$ differentially
PLL1 REFERENCE DIVIDER					
8-Bit Lowest Common Multiple (LCM) Dividers	1		255		
16-Bit R Divider (R1)	1		65,535		
PLL1 FEEDBACK DIVIDER					
16-Bit N Divider (N1)	1		65,535		
PLL1 FREQUENCY LIMITATIONS					
PLL1 REF Input Frequency ( $f_{\text{REF}}$ )	0.00015		800	MHz	Minimum specification set by Phase Detector 1 (PD1) low limit
Digital LOS/LCM Frequency ( $f_{\text{LCM}}$ )	0.00015		123	MHz	Typically run at about 38.4 MHz
PD1 Frequency ( $f_{\text{PD1}}$ )	0.00015		50	MHz	Minimum specification = VCXO minimum frequency $\div$ 65,535; 9.76 MHz typical
PLL1 CHARGE PUMP					
Charge Pump Current Range ( $I_{\text{CP1}}$ )		120 to 1920		$\mu\text{A}$	$I_{\text{CP1}}$ from 0 to 15, VCXO control voltage ( $V_{\text{TUNE}}$ ) = 1.4 V
$I_{\text{CP1}}$ Variation over Process Voltage Temperature (PVT)		$\pm 15$		%	$V_{\text{TUNE}} = 1.4 \text{ V}$
Source/Sink Current Mismatch		2		%	Source/sink mismatch at 1.4 V
Charge Pump Current Step Size		120		$\mu\text{A}$	
Charge Pump Compliance Range <sup>1</sup>		0.4 to 2.5		V	$I_{\text{CP}}$ variation less than 10%
		0.1 to 2.7		V	Maintain lock in test environment
PLL1 NOISE PROFILE <sup>1</sup>					
Floor Figure of Merit (FOM)		-222		dBc/Hz	Normalized to 1 Hz
Flicker FOM		-252		dBc/Hz	Normalized to 1 Hz
Flicker Noise		Determined by formula <sup>2</sup>		dBc/Hz	At $f_{\text{OUT}}$ , $f_{\text{OFFSET}}$
Noise Floor		Determined by formula <sup>3</sup>		dBc/Hz	At $f_{\text{OUT}}$ , $f_{\text{PD1}}$
Total Phase Noise (Unfiltered)		Determined by formula <sup>4</sup>		dBc/Hz	
PLL1 BANDWIDTH AND ACQUISITION TIMES <sup>1</sup>					
Supported Loop Bandwidths (PLL1_BW) <sup>5</sup>	$f_{\text{LCM}}/2^{25}$		$f_{\text{PD1}}/10$	Hz	Typically PLL1 low BW is set by the application and ranges between 5 Hz and 2 kHz
PLL1 Slew Time <sup>6</sup>			$N1/f_{\text{DELTA\_VCXO}}$	sec	$N1 = 10$ (typical) and $f_{\text{DELTA\_VCXO}} = 10$ kHz (typical) results in 1 ms of slew time
PLL1 Linear Acquisition Time		$5/\text{PLL1\_BW}$		sec	When VCXO has stopped slewing to steady state (within 5°)
PLL1 Phase Error at PD1 Invalidates Lock		$\pm 2.9$		ns	
PLL1 Lock Detect Timer Period ( $t_{\text{LKD}}$ ) <sup>7</sup>		4 to 2 <sup>26</sup>		$t_{\text{LCM}}$	User-selectable low phase error counts to declare lock

Parameter	Min	Typ	Max	Unit	Test Conditions/Comments
<b>PLL1 BEHAVIOR ON REFERENCE FAILURE<sup>1</sup></b>					
LOS Assertion Delay <sup>7</sup>	2 + t <sub>DGPO</sub>		3 + t <sub>DGPO</sub>	t <sub>LCM</sub>	From missing signal edge to alarm on GPO
Erroneously Active I <sub>CP1</sub> Time on Reference Failure <sup>8</sup>	0		8	ns	
Temporary Frequency Glitch Due to Reference Failure		0.03		ppm	I <sub>CP1</sub> = 1 mA, C12 = 4.6 nF, Crystek CVPD-952 VCXO
Integrated Frequency Error Due to Reference Failure		0.016		ppm	I <sub>CP1</sub> = 1 mA, C13 = 1 μF, Crystek CVPD-952 VCXO
Signal Valid Time to Clear LOS <sup>9</sup>	2		3	t <sub>LOSVAL</sub>	
<b>PLL1 V<sub>TUNE</sub> LEAKAGE SOURCES</b>					
Charge Pump Tristate Leakage Current		0.2		nA	
Board Level XTAL Tune Input Port		0.5		nA	Crystek CVPD-952 VCXO
Board Level Loop Filter Components		2		nA	C12 = 4.6 nF, C13 = 1 μF, R9 = 11 kΩ, C15 = unpopulated
<b>HOLDOVER CHARACTERISTICS</b>					
V <sub>TUNE</sub> Drift Over 1 sec in Tristate Mode		2		mV	C12 = 4.6 nF, C13 = 1 μF, R9 = 11 kΩ, CVPD-950 VCXO
<b>Holdover</b>					
Analog-to-Digital Converter (ADC)/Digital-to-Analog Converter (DAC) Resolution		19		mV	7-bit, monotonic, no missing code
ADC/DAC Code 0 Voltage		0.28		V	
ADC/DAC Code 127 Voltage		2.71		V	
DAC Temperature Stability		0.07		mV/°C	At maximum code
ADC/DAC Integral Nonlinearity (INL)		-0.11		LSBs	Worst case across codes
Holdoff Timer Period <sup>1, 10</sup>	1		2 <sup>26</sup>	t <sub>LCM</sub>	
<b>HOLDOVER EXIT—INITIAL PHASE OFFSETS<sup>1</sup></b>					
Exit Criteria = Wait for Low Phase Error					
Exit Action = None		±4		ns	The phase offset to make up after a transition from holdover to acquisition when using this feature
Exit Criteria = Any <sup>11</sup>					
Exit Action = Reset Dividers	1		2	t <sub>VCXO</sub>	Assumes N2 > 3 and dividers are reset upon exit; note that VCXO lags at start; value applies as the starting phase error if DAC assisted release is used
Exit Action = None			±N1	t <sub>VCXO</sub>	Dividers are not reset upon exit
<b>HOLDOVER EXIT CHARACTERISTICS<sup>1, 12</sup></b>					
DAC Assisted Release Period per Step (t <sub>DACASSIST</sub> )	1/2		1/16	t <sub>LKD</sub>	Based on lock detect timer setpoint
DAC Assisted Release Time			9	t <sub>DACASSIST</sub>	Time from decision to leave holdover until in fully natural acquisition; assumes no interruption by LOS or user
Delay of Exit Criteria <sup>13</sup> = Wait for Low Phase Error <sup>14</sup>			N1/f <sub>ERR_VCXO</sub>	sec	

Parameter	Min	Typ	Max	Unit	Test Conditions/Comments
HOLDOVER EXIT—FREQUENCY TRANSIENTS vs. MODE Peak Frequency Transient DAC Assisted Release		2		ppm	Only available if using DAC-based holdover

<sup>1</sup> Guaranteed by design and characterization.

<sup>2</sup> See the PLL1 Noise Calculations section for more information on how to calculate the flicker noise for PLL1.

<sup>3</sup> See the PLL1 Noise Calculations section for more information on how to calculate the noise floor for PLL1.

<sup>4</sup> See the PLL1 Noise Calculations section for more information on how to calculate the total phase noise (unfiltered) for PLL1.

<sup>5</sup> Set by external components. Set the lock detect thresholds (PLL1 Lock Detect Timer[4:0] in Register 0x0028) appropriately in the SPI.

<sup>6</sup> Depends on initial phase offset (worst case is proportional to N1) and VCXO excess tuning range available over the target ( $f_{\Delta, VCXO}$ ). For PFD rates typical of PLL1, cycle slipping is normally insignificant.

<sup>7</sup>  $t_{LCM}$  is the least common multiple (LCM) of PLL1 clock input frequencies. The specification is given in multiples of  $t_{LCM}$ .

<sup>8</sup> If LOS triggers before the PFD edge is normally detected (more likely with high R1 values), the charge pump is more likely to disable before the next invalid comparison occurs. Otherwise, the fast tristate circuit disables the charge pump after about 4 ns (8 ns worst case) of phase error.

<sup>9</sup>  $t_{LOSVAL}$  is a register value that is programmable from 1, 2, 4, ..., 64  $t_{LCM}$ .

<sup>10</sup> If the holdoff timer is used, the finite state machine (FSM) stays in holdover after LOS of the active reference before switching clocks, giving the original clock a chance to return.

<sup>11</sup>  $t_{VCXO}$  is the VCXO clock period.

<sup>12</sup> See the PLL1 Holdover Exit section.

<sup>13</sup> The time required for the phases to intersect is inversely proportional to the holdover frequency error. Note that the frequency error during holdover is expected to be much smaller than is available from the tuning range of the VCXO.

<sup>14</sup>  $f_{ERR, VCXO}$  is the error frequency of the VCXO.

## PLL2 CHARACTERISTICS

Table 5.

Parameter	Min	Typ	Max	Unit	Test Conditions/Comments
PLL2 VCXO INPUT					
Recommended Swing					
Differential	0.2		1.4	V p-p	Differential, keep signal at OSCIN and $\overline{\text{OSCIN}}$ pins < 2.8 V
Single-Ended (<250 MHz) <sup>1</sup>	0.2		1.4	V p-p	Keep signal at OSCIN and $\overline{\text{OSCIN}}$ pins < 2.8 V
Common-Mode Range	1.6	2.1	2.4	V	If user supplied, on-chip $V_{CM}$ is approximately 2.1 V
VCXO Input Slew Rate	300			mV/ns	Slew rates as low as 100 mV/ns are functional, but can degrade the phase noise plateau by about 3 dB
Input Capacitance		1.5		pF	Per side; 3 pF differential
Differential Input Resistance		100 to 1000		$\Omega$	User selectable
Return Loss		-12		dB	When terminated with 100 $\Omega$ differential
PLL2 EXTERNAL VCO INPUT					
Recommended Input Power, AC-Coupled					
Differential	-6		6	dBm	
Single-Ended <sup>1</sup>	-6		6	dBm	
Return Loss		-12		dB	When terminated with 100 $\Omega$ differential
External VCO Frequency <sup>1</sup>	400		3200	MHz	Fundamental mode; if < 1 GHz, set the low frequency external VCO path bit (Register 0x0064, Bit 0)
	400		6000	MHz	Using external VCO $\div 2$
Common-Mode Range <sup>1</sup>	1.6	2.1	2.2	V	
PLL2 DIVIDERS					
12-Bit Reference Divider Range (R2)	1		4095		
16-Bit Feedback Divider Range (N2)	8		65,535		
PLL2 FREQUENCY LIMITATIONS					
VCXO Frequency ( $f_{VCXO}$ )	10		500	MHz	122.88 MHz or 155 MHz are typical
VCXO Duty Cycle Using Doubler <sup>1</sup>	40		60	%	Distortion can lead to a spur at $f_{PD}/2$ offset, note that minimum pulse width > 3 ns

Parameter	Min	Typ	Max	Unit	Test Conditions/Comments
Reference Doubler Input Frequency	10		175	MHz	
R2 Input Frequency	10		500	MHz	
PD2 Frequency ( $f_{PD2}$ )	0.00015		250	MHz	Recommended at high end of the range for best phase noise; typically 122.88 MHz $\times$ 2
PLL2 CHARGE PUMP					
Current Range ( $I_{CP2}$ )		160 to 2560		$\mu$ A	$I_{CP2}$ setting from 0 to 15 with 160 $\mu$ A step size, $V_{TUNE} = 1.4$ V
$I_{CP2}$ Variation over PVT		$\pm 25$		%	$V_{TUNE} = 1.4$ V
Source/Sink Current Mismatch		2		%	Source/sink mismatch at 1.4 V
Current Step Size		160		$\mu$ A	
Compliance Range		0.3 to 2.45		V	$I_{CP}$ variation less than 10%
PLL2 NOISE PROFILE					
Floor FOM		-232		dBc/Hz	Normalized to 1 Hz
Flicker FOM		-266		dBc/Hz	Normalized to 1 Hz
FOM Variation vs. PVT		$\pm 3$		dB	
FOM Degradation		3		dB	At minimum VCXO slew rate
PLL2 Flicker Noise		Determined by formula <sup>2</sup>		dBc/Hz	At $f_{OUT}$ , $f_{OFFSET}$
PLL2 Noise Floor		Determined by formula <sup>3</sup>		dBc/Hz	At $f_{OUT}$ , $f_{PD2}$
PLL2 Total Phase Noise (Unfiltered)		Determined by formula <sup>4</sup>		dBc/Hz	
PLL2 BANDWIDTH AND ACQUISITION TIMES					
Supported Loop Bandwidths (PLL2_BW)		10 to 700		kHz	Set by external components
VCO Automatic Gain Control (AGC) Settling Time <sup>1</sup>		10	20	ms	Time from power-up of VCO before initiating calibration; this applies to the 100 nF/1 $\mu$ F configuration of external decoupling capacitors on the VCO supply network
VCO Calibration Time <sup>5</sup>		2694		$t_{PD2}$	N2 from 8 to 31
		779		$t_{PD2}$	N2 from 32 to 256
		214		$t_{PD2}$	N2 from 256 to 4095
		139		$t_{PD2}$	N2 > 4095
Temperature Range Postcalibration <sup>1</sup>	-40		+85	$^{\circ}$ C	Maintains lock from any temperature to any temperature
PLL2 Linear Acquisition Time		5/PLL2_BW		sec	After VCXO has stopped slewing to steady state
PLL2 Lock Detect Timer Period <sup>5</sup>		512		$t_{PD2}$	Low phase error counts to declare lock

<sup>1</sup> Guaranteed by design and characterization.

<sup>2</sup> See the PLL2 Noise Calculations section for more information on how to calculate the flicker noise for PLL2.

<sup>3</sup> See the PLL2 Noise Calculations section for more information on how to calculate the noise floor for PLL2.

<sup>4</sup> See the PLL2 Noise Calculations section for more information on how to calculate the total phase noise (unfiltered) for PLL2.

<sup>5</sup>  $t_{PD2}$  is the period of Phase Detector 2.

## VCO CHARACTERISTICS

Table 6.

Parameter	Min	Typ	Max	Unit	Test Conditions/Comments
VOLTAGE CONTROLLED OSCILLATOR (VCO)					
Frequency Tuning Range, On-Board VCOs <sup>1</sup>	2150		2880	MHz	Low VCO typical coverage
	2650		3550	MHz	High VCO typical coverage
	2400		3200	MHz	Guaranteed frequency coverage <sup>2</sup>
Tuning Sensitivity		38 to 44		MHz/V	Low frequency VCO at 2457.6 MHz
		35 to 40		MHz/V	High frequency VCO at 2949.12 MHz



Parameter	Min	Typ	Max	Unit	Test Conditions/Comments
OPEN-LOOP VCO PHASE NOISE					
$f_{OUT} = 2457.6$ MHz					
$f_{OFFSET} = 100$ kHz		-109		dBc/Hz	High performance mode, does not include floor contribution due to output network
$f_{OFFSET} = 800$ kHz		-134		dBc/Hz	
$f_{OFFSET} = 1$ MHz		-136		dBc/Hz	
$f_{OFFSET} = 10$ MHz		-156		dBc/Hz	
Normalized Phase Noise Variation vs. Frequency		$\pm 2$		dB	Sweep across both VCOs, all bands; normalize to 2457.6 MHz
Phase Noise Variation vs. Temperature		$\pm 2$		dB	
Phase Noise Degradation in Low Performance Mode		2		dB	

<sup>1</sup> Guaranteed by design and characterization.

<sup>2</sup> Although the device covers this range without any gaps, for frequencies between ~2700 Hz and 2900 Hz, using a different VCO core to synthesize the frequency can be required as process parameters shift. Features are built into the HMC7044 to determine which core is selected for a given frequency that can fall in this range, but it can require software to configure these circuits appropriately.

## CLOCK OUTPUT DISTRIBUTION CHARACTERISTICS

Table 7.

Parameter	Min	Typ	Max	Unit	Test Conditions/Comments
CLOCK OUTPUT SKEW					
CLKOUTx/CLKOUTx to SCLKOUTx/SCLKOUTx		15		ps	Same pair, same type termination and configuration
Skew within One Clock Output Pair					
Any CLKOUTx/CLKOUTx to Any SCLKOUTx/SCLKOUTx		30		ps	Any pair, same type termination and configuration
CLOCK OUTPUT DIVIDER					
12-Bit Divider Range	1		4094		1, 3, 5, and all even numbers up to 4094
SYSREF CLOCK OUTPUT DIVIDER					
12-Bit Divider Range	1		4094		1, 3, 5 and all even numbers up to 4094; pulse generator behavior is only supported for divide ratios $\geq 32$
CLOCK OUTPUT ANALOG FINE DELAY					
Analog Fine Delay					
Adjustment Range <sup>1</sup>	135		670	ps	24 delay steps, $f_{CLKOUT} = 983.04$ MHz
Resolution		25		ps	$f_{CLKOUT} = 983.04$ MHz (2949.12 MHz/3)
Maximum Analog Fine Delay Frequency <sup>1</sup>		3200		MHz	
CLOCK OUTPUT COARSE DELAY (FLIP FLOP BASED)					
Coarse Delay Adjustment Range	0		17	$\frac{1}{2}$ VCO period	17 delay steps in $\frac{1}{2}$ VCO period
Coarse Delay Resolution		169.54		ps	$f_{VCO} = 2949.12$ MHz
Maximum Frequency Coarse Delay <sup>1</sup>		3200		MHz	
CLOCK OUTPUT COARSE DELAY (SLIP BASED)					
Coarse Delay					
Adjustment Range		1 to $\infty$		VCO period	$f_{VCO} = 2949.12$ MHz
Resolution		339.08		ps	
Maximum Frequency Coarse Delay		1600		MHz	

<sup>1</sup> Guaranteed by design and characterization.

## SPUR CHARACTERISTICS

Table 8.

Parameter	Min	Typ	Max	Unit	Test Conditions/Comments
REFERENCE SPUR PERFORMANCE At 122.88 MHz and Its Harmonics		-70		dBc	

## NOISE AND JITTER CHARACTERISTICS

Table 9.

Parameter	Min	Typ	Max	Unit	Test Conditions/Comments
CLOSED-LOOP PHASE NOISE—WIDE LOOP FILTER SSB Phase Noise At 2457.6 MHz <sup>1</sup>					For best integrated noise
		-98.0		dBc/Hz	Offset = 100 Hz
		-111.1		dBc/Hz	Offset = 1 kHz
		-119.8		dBc/Hz	Offset = 10 kHz
		-125.2		dBc/Hz	Offset = 100 kHz
		-126.9		dBc/Hz	Offset = 300 kHz
		-131.3		dBc/Hz	Offset = 1 MHz
		-150.0		dBc/Hz	Offset = 5 MHz
		-154.0		dBc/Hz	Offset = 10 MHz
		-156.3		dBc/Hz	Offset = 100 MHz
At 614.4 MHz <sup>1</sup>		44.0		fs	Integrated jitter = 12 kHz to 20 MHz
		-110.4		dBc/Hz	Offset = 100 Hz
		-122.8		dBc/Hz	Offset = 1 kHz
		-131.3		dBc/Hz	Offset = 10 kHz
		-136.6		dBc/Hz	Offset = 100 kHz
		-138.3		dBc/Hz	Offset = 300 kHz
		-142.7		dBc/Hz	Offset = 1 MHz
		-157.6		dBc/Hz	Offset = 5 MHz
		-158.8		dBc/Hz	Offset = 10 MHz
		-159.2		dBc/Hz	Offset = 100 MHz
		50.0		fs	Integrated jitter = 12 kHz to 20 MHz
CLOSED-LOOP PHASE NOISE—NARROW LOOP FILTER SSB Phase Noise At 2949.12 MHz <sup>2</sup>					For best 800 kHz offset
		-100.9		dBc/Hz	Offset = 100 Hz
		-103.8		dBc/Hz	Offset = 1 kHz
		-106.9		dBc/Hz	Offset = 10 kHz
		-109.9		dBc/Hz	Offset = 100 kHz
		-132.3		dBc/Hz	Offset = 800 kHz
		-134.5		dBc/Hz	Offset = 1 MHz
		-152		dBc/Hz	Offset = 10 MHz
		-155.3		dBc/Hz	Offset = 100 MHz
		108		fs	Integrated jitter = 12 kHz to 20 MHz
At 983.04 MHz <sup>2</sup>					
		-110.4		dBc/Hz	Offset = 100 Hz
		-113.3		dBc/Hz	Offset = 1 kHz
		-116.4		dBc/Hz	Offset = 10 kHz
		-119.4		dBc/Hz	Offset = 100 kHz
		-141.7		dBc/Hz	Offset = 800 kHz
		-143.7		dBc/Hz	Offset = 1 MHz
		-157.1		dBc/Hz	Offset = 10 MHz

Parameter	Min	Typ	Max	Unit	Test Conditions/Comments
		-157.1 102		dBc/Hz fs	Offset = 100 MHz Integrated jitter 12 kHz to 20 MHz
OUTPUT NETWORK FLOOR FOM					
CML with 100 $\Omega$ Internal Termination (CML100)					
Fundamental Mode		-250		dBc/Hz	High performance
Divide by 1 to Divide by N		-248		dBc/Hz	High performance
Divide by 1 to Divide by N		-247		dBc/Hz	Low power (4 dB less power)
LVPECL					
Fundamental Mode		-250		dBc/Hz	
Divide by 1 to Divide by N		-247		dBc/Hz	
LVDS					
Divide by 1 to Divide by N		-244		dBc/Hz	High performance
Divide by 1 to Divide by N		-243		dBc/Hz	Low power (4 dB less power)
PHASE NOISE DEGRADATION DUE TO HARMONICS <sup>3</sup>					
Fundamental Only		0.00		dB	
Third Harmonic		0.25		dB	
Third and Fifth Harmonics		0.40		dB	
Third, Fifth, and Seventh Harmonics		0.50		dB	
Third, Fifth, Seventh, and Ninth Harmonics		0.53		dB	
Third Through 61 <sup>st</sup> Harmonics		0.64		dB	
PHASE NOISE FLOOR AND JITTER					
Phase Noise Floor at $f_{OUT}$		Determined by formula <sup>4</sup>		dBc/Hz	
Jitter Density of Floor at $f_{OUT}$		Determined by formula <sup>5</sup>		sec/ $\sqrt{\text{Hz}}$	
RMS Additive Jitter Due to Floor		Determined by formula <sup>6</sup>		sec	From $f_{OUT}$ and output channel FOM

<sup>1</sup> PLL2 locked at 122.88 MHz  $\times 2 \times 10$ , wide (600 kHz) loop filter for best 12 kHz to 20 MHz jitter, CML100 high performance output buffer.

<sup>2</sup> PLL2 locked at 122.88 MHz  $\times 2 \times 12$ , narrow loop for best 800 Hz offset, CML100 high performance output buffer.

<sup>3</sup> When the harmonics of the signal are captured in the measurement bandwidth of the receiving instrument/circuit, the noise power of those harmonics can fold and influence the overall noise. Their presence causes a decibel for decibel influence. For example, if the third harmonic is at -10 dBc, there is an additional noise contributor of 10 dB lower than the fundamental at all offsets that folds in-band and causes a 0.2 dB hit overall. The influence of the harmonics factoring into the degradation is primarily a function of the frequency of the buffer bandwidth relative to the third, fifth, and seventh harmonics. As the output frequency reduces, more harmonics fall into the observation bandwidth, and the degradation worsens, but only slightly. This effect produces a penalty of 0.65 dB maximum if harmonics up to the 61<sup>st</sup> harmonic is included.

<sup>4</sup> See the Phase Noise Floor and Jitter section for more information on how to calculate the phase noise floor.

<sup>5</sup> See the Phase Noise Floor and Jitter section for more information on how to calculate the jitter density of floor.

<sup>6</sup> See the Phase Noise Floor and Jitter section for more information on how to calculate the rms additive jitter due to floor.

## CLOCK OUTPUT DRIVER CHARACTERISTICS

Table 10.

Parameter	Min	Typ	Max	Unit	Test Conditions/Comments
CML MODE (LOW POWER)					$R_L = 100 \Omega$ , 9.6 mA
-3 dB Bandwidth		1950		MHz	Differential output voltage = 980 mV p-p diff
Output Rise Time		175		ps	$f_{CLKOUT} = 245.76$ MHz, 20% to 80%
		145		ps	$f_{CLKOUT} = 983.04$ MHz, 20% to 80%
Output Fall Time		185		ps	$f_{CLKOUT} = 245.76$ MHz, 20% to 80%
		145		ps	$f_{CLKOUT} = 983.04$ MHz, 20% to 80%
Output Duty Cycle <sup>1</sup>	47.5	50	52.5	%	$f_{CLKOUT} = 1075$ MHz (2150 MHz/2)
Differential Output Voltage Magnitude		1390		mV p-p diff	$f_{CLKOUT} = 245.76$ MHz (2949.12 MHz/12)
		1360		mV p-p diff	$f_{CLKOUT} = 983.04$ MHz (2949.12 MHz/3)
Common-Mode Output Voltage		$V_{CC} - 1.05$		V	$f_{CLKOUT} = 245.76$ MHz (2949.12 MHz/12)
CML MODE (HIGH POWER)					$R_L = 100 \Omega$ , 14.5 mA
3 dB Bandwidth		1400		MHz	Differential output voltage = 1410 mV p-p diff
Output Rise Time		250		ps	$f_{CLKOUT} = 245.76$ MHz, 20% to 80%
		165		ps	$f_{CLKOUT} = 983.04$ MHz, 20% to 80%
Output Fall Time		255		ps	$f_{CLKOUT} = 245.76$ MHz, 20% to 80%
		170		ps	$f_{CLKOUT} = 983.04$ MHz, 20% to 80%

Parameter	Min	Typ	Max	Unit	Test Conditions/Comments
Output Duty Cycle <sup>1</sup>	47.5	50	52.5	%	f <sub>CLKOUT</sub> = 1075 MHz (2150 MHz/2)
Differential Output Voltage Magnitude		2000		mV p-p diff	f <sub>CLKOUT</sub> = 245.76 MHz (2949.12 MHz/12)
Common-Mode Output Voltage		1800		mV p-p diff	f <sub>CLKOUT</sub> = 983.04 MHz (2949.12 MHz/3)
		V <sub>CC</sub> - 1.6		V	f <sub>CLKOUT</sub> = 245.76 MHz (2949.12 MHz/12)
LVPECL MODE					R <sub>L</sub> = 150 Ω, 4.8 mA
3 dB Bandwidth		2400		MHz	Differential output voltage = 1240 mV p-p diff
Output Rise Time		135		ps	f <sub>CLKOUT</sub> = 245.76 MHz, 20% to 80%
		130		ps	f <sub>CLKOUT</sub> = 983.04 MHz, 20% to 80%
Output Fall Time		135		ps	f <sub>CLKOUT</sub> = 245.76 MHz, 20% to 80%
		130		ps	f <sub>CLKOUT</sub> = 983.04 MHz, 20% to 80%
Output Duty Cycle <sup>1</sup>	47.5	50	52.5	%	f <sub>CLKOUT</sub> = 1075 MHz (2150 MHz/2)
Differential Output Voltage Magnitude		1760		mV p-p diff	f <sub>CLKOUT</sub> = 245.76 MHz (2949.12 MHz/12)
Common-Mode Output Voltage		1850		mV p-p diff	f <sub>CLKOUT</sub> = 983.04 MHz (2949.12 MHz/3)
		V <sub>CC</sub> - 1.3		V	f <sub>CLKOUT</sub> = 245.76 MHz (2949.12 MHz/12)
LVDS MODE (LOW POWER)					1.75 mA
Maximum Operating Frequency		600		MHz	Differential output voltage = 400 mV p-p diff
Output Rise Time		135		ps	f <sub>CLKOUT</sub> = 245.76 MHz, 20% to 80%
		100		ps	f <sub>CLKOUT</sub> = 983.04 MHz, 20% to 80%
Output Fall Time		135		ps	f <sub>CLKOUT</sub> = 245.76 MHz, 20% to 80%
		95		ps	f <sub>CLKOUT</sub> = 983.04 MHz, 20% to 80%
Output Duty Cycle <sup>1</sup>	47.5	50	52.5	%	f <sub>CLKOUT</sub> = 1075 MHz (2150 MHz/2)
Differential Output Voltage Magnitude		390		mV p-p diff	f <sub>CLKOUT</sub> = 245.76 MHz (2949.12 MHz/12)
Common-Mode Output Voltage		1.1		V	f <sub>CLKOUT</sub> = 245.76 MHz (2949.12 MHz/12)
LVDS MODE (HIGH POWER)					3.5 mA
Maximum Operating Frequency		1700		MHz	Differential output voltage = 650 mV p-p diff
Output Rise Time		145		ps	f <sub>CLKOUT</sub> = 245.76 MHz, 20% to 80%
		105		ps	f <sub>CLKOUT</sub> = 983.04 MHz, 20% to 80%
Output Fall Time		145		ps	f <sub>CLKOUT</sub> = 245.76 MHz, 20% to 80%
		100		ps	f <sub>CLKOUT</sub> = 983.04 MHz, 20% to 80%
Output Duty Cycle <sup>1</sup>	47.5	50	52.5	%	f <sub>CLKOUT</sub> = 1075 MHz (2150 MHz/2)
Differential Output Voltage Magnitude		750		mV p-p diff	f <sub>CLKOUT</sub> = 245.76 MHz (2949.12 MHz/12)
		730		mV p-p diff	f <sub>CLKOUT</sub> = 983.04 MHz (2949.12 MHz/3)
Common-Mode Output Voltage		1.1		V	f <sub>CLKOUT</sub> = 245.76 MHz (2949.12 MHz/12)
CMOS MODE					
Maximum Operating Frequency		600		MHz	Single-ended output voltage = 940 mV p-p diff
Output Rise Time		425		ps	f <sub>CLKOUT</sub> = 245.76 MHz, 20% to 80%
Output Fall Time		420		ps	f <sub>CLKOUT</sub> = 245.76 MHz, 20% to 80%
Output Duty Cycle <sup>1</sup>	47.5	50	52.5	%	f <sub>CLKOUT</sub> = 1075 MHz (2150 MHz/2)
Output Voltage		High	V <sub>CC</sub> - 0.07	V	Load current = 1 mA
			V <sub>CC</sub> - 0.5	V	Load current = 10 mA
Output			0.07	V	Load current = 1 mA
			0.5	V	Load current = 10 mA

<sup>1</sup> Guaranteed by design and characterization.

## ABSOLUTE MAXIMUM RATINGS

Table 11.

Parameter	Rating
VCC1_VCO, VCC2_OUT, VCC3_SYSREF, VCC4_OUT, VCC5_PLL1, VCC6_OSCOUT, VCC7_PLL2, VCC8_OUT, VCC9_OUT	−0.3 V to +3.6 V
Maximum Junction Temperature (T <sub>j</sub> )	125°C
Maximum Peak Reflow Temperature	260°C
Thermal Resistance (Channel to Ground Paddle)	7°C/W
Storage Temperature Range	−65°C to +150°C
Operating Temperature Range	−40°C to +85°C
ESD Sensitivity Level	
Human Body Model	Class 1C
Charged Device Model <sup>1</sup>	Class 3

<sup>1</sup> Per JESD22-C101-F (CDM) standard.

Stresses at or above those listed under Absolute Maximum Ratings may cause permanent damage to the product. This is a stress rating only; functional operation of the product at these or any other conditions above those indicated in the operational section of this specification is not implied. Operation beyond the maximum operating conditions for extended periods may affect product reliability.

### ESD CAUTION



**ESD (electrostatic discharge) sensitive device.** Charged devices and circuit boards can discharge without detection. Although this product features patented or proprietary protection circuitry, damage may occur on devices subjected to high energy ESD. Therefore, proper ESD precautions should be taken to avoid performance degradation or loss of functionality.

# PIN CONFIGURATION AND FUNCTION DESCRIPTIONS

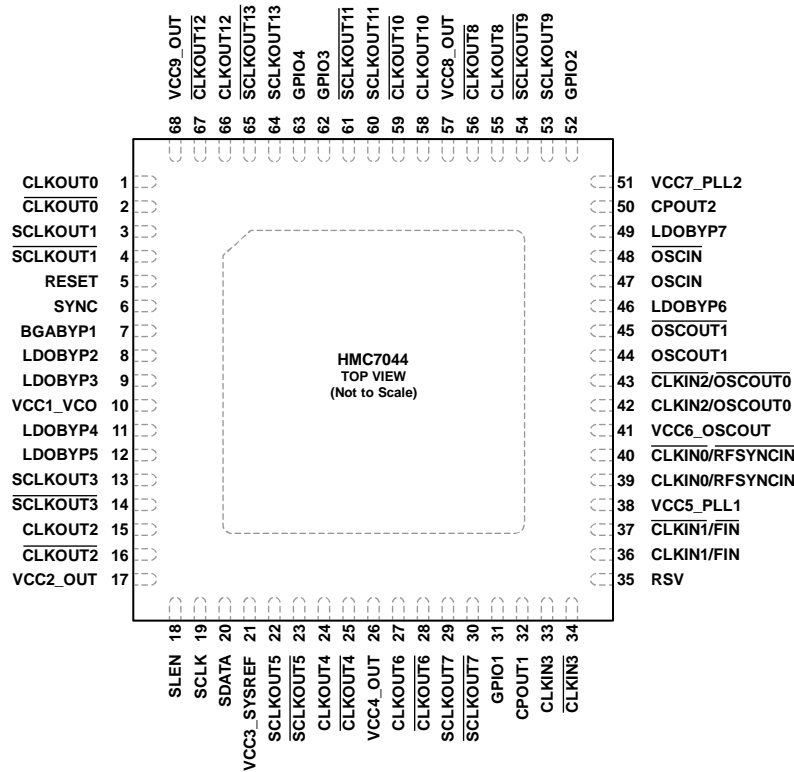

- NOTES**  
 1. EXPOSED PAD. CONNECT THE EXPOSED PAD TO A HIGH QUALITY RF/DC GROUND.

Figure 2. Pin Configuration

Table 12. Pin Function Descriptions

Pin No.	Mnemonic	Type <sup>1</sup>	Description
1	CLKOUT0	O	True Clock Output Channel 0. Default DCLK profile.
2	CLKOUT0	O	Complementary Clock Output Channel 0. Default DCLK profile.
3	SCLKOUT1	O	True Clock Output Channel 1. Default SYSREF profile.
4	SCLKOUT1	O	Complementary Clock Output Channel 1. Default SYSREF profile.
5	RESET	I	Device Reset Input. Active high. For normal operation, set RESET to 0.
6	SYNC	I	Synchronization Input. This pin is used for multichip synchronization. If not used, set SYNC to 0.
7	BGABYP1		Band Gap Bypass Capacitor Connection. Connect a 4.7 μF capacitor to ground. This pin affects all internally regulated supplies.
8	LDOBYP2		LDO Bypass 2. Connect a 4.7 μF capacitor to ground. The internal digital supply is 1.8 V. This pin is the LDO bypass for the PLL1, PLL2, and SYSREF sections.
9	LDOBYP3		LDO Bypass 3. Connect a 4.7 μF capacitor to ground. This pin is the 2.8 V supply to PLL1, Phase Frequency Detector 1 (PFD1), Charge Pump 1 (CP1), RF synchronization (RFSYNC), and Pin 36 buffers.
10	VCC1_VCO	P	3.3 V Supply for VCO and VCO Distribution.
11	LDOBYP4		LDO Bypass 4. Connect a 1 μF capacitor to ground. This pin is the first stage regulator for the VCO supply.
12	LDOBYP5		LDO Bypass 5. Connect a 100 nF capacitor to LDOBYP4. This pin is the VCO core supply voltage.
13	SCLKOUT3	O	True Clock Output Channel 3. Default SYSREF profile.
14	SCLKOUT3	O	Complementary Clock Output Channel 3. Default SYSREF profile.
15	CLKOUT2	O	True Clock Output Channel 2. Default DCLK profile.
16	CLKOUT2	O	Complementary Clock Output Channel 2. Default DCLK profile.
17	VCC2_OUT	P	Power Supply for Clock Group 1 (Southwest)—Channel 2 and Channel 3. See the Clock Grouping, Skew, and Crosstalk section.
18	SLEN	I	SPI Latch Enable.

Pin No.	Mnemonic	Type <sup>1</sup>	Description
19	SCLK	I	SPI Clock.
20	SDATA	I/O	SPI Data.
21	VCC3_SYSREF	P	Power Supply for Common SYSREF Divider.
22	<u>SCLKOUT5</u>	O	True Clock Output Channel 5. Default SYSREF profile.
23	<u>SCLKOUT5</u>	O	Complementary Clock Output Channel 5. Default SYSREF profile.
24	<u>CLKOUT4</u>	O	True Clock Output Channel 4. Default DCLK profile.
25	<u>CLKOUT4</u>	O	Complementary Clock Output Channel 4. Default DCLK profile.
26	VCC4_OUT	P	Power Supply for Clock Group 2 (South)—Channel 4, Channel 5, Channel 6, and Channel 7. See the Clock Grouping, Skew, and Crosstalk section.
27	<u>CLKOUT6</u>	O	True Clock Output Channel 6. Default DCLK profile.
28	<u>CLKOUT6</u>	O	Complementary Clock Output Channel 6. Default DCLK profile.
29	<u>SCLKOUT7</u>	O	True Clock Output Channel 7. Default SYSREF profile.
30	<u>SCLKOUT7</u>	O	Complementary Clock Output Channel 7. Default SYSREF profile.
31	GPIO1	I/O	Programmable General-Purpose Input/Output 1.
32	CPOUT1	O	PLL1 Charge Pump Output.
33	<u>CLKIN3</u>	I	True Reference Clock Input 3 of PLL1.
34	<u>CLKIN3</u>	I	Complementary Reference Clock Input 3 of PLL1.
35	RSV	R	Reserved Pin. This pin must be tied to ground.
36	<u>CLKIN1/FIN</u>	I	True Reference Clock Input 1 of PLL1/External VCO Input for External VCO Mode.
37	<u>CLKIN1/FIN</u>	I	Complementary Reference Clock Input 1 of PLL1/Complementary External VCO Input for External VCO Mode.
38	VCC5_PLL1	P	Power Supply for LDO, Used for PLL1.
39	<u>CLKIN0/RFSYNCIN</u>	I	True Reference Clock Input 0 of PLL1/RF Synchronization Input with Deterministic Delay.
40	<u>CLKIN0/RFSYNCIN</u>	I	Complementary Reference Clock Input 0 of PLL1/Complementary RF Synchronization Input with Deterministic Delay.
41	VCC6_OSCOUT	P	Power Supply for Oscillator Output Path.
42	<u>CLKIN2/OSCOU0</u>	I/O	True Reference Clock Input 2 (Bidirectional Pin) of PLL1/Buffered Output 0 of Oscillator Input.
43	<u>CLKIN2/OSCOU0</u>	I/O	Complementary Reference Clock Input 2 (Bidirectional Pin) of PLL1/Complementary Buffered Output 0 of Oscillator Input.
44	<u>OSCOU1</u>	O	True Buffered Output 1 of Oscillator Input.
45	<u>OSCOU1</u>	O	Complementary Buffered Output 1 of Oscillator Input.
46	LDOBYP6		LDO Bypass, Connect a 4.7 $\mu$ F capacitor to ground. This pin is the LDO bypass for R2, N2, Phase Frequency Detector 2 (PFD2), Charge Pump 2 (CP2), and the PLL2 loop filter.
47	<u>OSCIN</u>	I	True Feedback Input to PLL1. This pin is a reference input to PLL2.
48	<u>OSCIN</u>	I	Complementary Feedback Input to PLL1. This pin is a reference input to PLL2.
49	LDOBYP7		LDO Bypass. Connect a 4.7 $\mu$ F capacitor to ground. This pin is the LDO bypass for the VCXO buffer and frequency doubler oscillator output divider.
50	CPOUT2	I/O	PLL2 Charge Pump Output.
51	VCC7_PLL2	P	Power Supply for LDO for PLL2.
52	GPIO2	I/O	Programmable General-Purpose Input/Output 2.
53	<u>SCLKOUT9</u>	O	True Clock Output Channel 9. Default SYSREF profile.
54	<u>SCLKOUT9</u>	O	Complementary Clock Output Channel 9. Default SYSREF profile.
55	<u>CLKOUT8</u>	O	True Clock Output Channel 8. Default DCLK profile.
56	<u>CLKOUT8</u>	O	Complementary Clock Output Channel 8. Default DCLK profile.
57	VCC8_OUT	P	Power Supply for Clock Group 3 (North)—Channel 8, Channel 9, Channel 10, and Channel 11. See the Clock Grouping, Skew, and Crosstalk section.
58	<u>CLKOUT10</u>	O	True Clock Output Channel 10. Default DCLK profile.
59	<u>CLKOUT10</u>	O	Complementary Clock Output Channel 10. Default DCLK profile.
60	<u>SCLKOUT11</u>	O	True Clock Output Channel 11. Default SYSREF profile.
61	<u>SCLKOUT11</u>	O	Complementary Clock Output Channel 11. Default SYSREF profile.
62	GPIO3	I/O	Programmable General-Purpose Input/Output 3. Sleep input by default.
63	GPIO4	I/O	Programmable General-Purpose Input/Output 4. Pulse generator request by default.
64	SCLKOUT13	O	True Clock Output Channel 13. Default SYSREF profile.

Pin No.	Mnemonic	Type <sup>1</sup>	Description
65	SCLKOUT13	O	Complementary Clock Output Channel 13. Default SYSREF profile.
66	CLKOUT12	O	True Clock Output Channel 12. Default DCLK profile.
67	CLKOUT12	O	Complementary Clock Output Channel 12. Default DCLK profile.
68	VCC9_OUT	P	Power Supply for Clock Group 0 (Northwest)—Channel 0, Channel 1, Channel 12, and Channel 13. See the Clock Grouping, Skew, and Crosstalk section.
	EP		Exposed Pad. Connect the exposed pad to a high quality RF/dc ground.

<sup>1</sup> O is output, I is input, P is power, and I/O is input/output.



# TYPICAL PERFORMANCE CHARACTERISTICS

Unless otherwise noted, PFD PLL1 = 7.68 MHz, PFD PLL2 = 122.88 MHz × 2; I<sub>CP1</sub> = 1.92 mA, I<sub>CP2</sub> = 2.56 mA (wide loop), I<sub>CP2</sub> = 1.12 mA (narrow loop), PLL1 loop BW ~ 70 Hz, PLL2 wide loop BW ≈ 650 kHz, PLL2 narrow loop BW ≈ 215 kHz, PLL2 narrow loop filter = 1.1 nF | 160 Ω × 33 nF; PLL2 wide loop filter = 150 pF | 430 Ω × 4.7 nF; PLL1 loop filter = 4.7 nF | 10 μF × 1.2 kΩ.

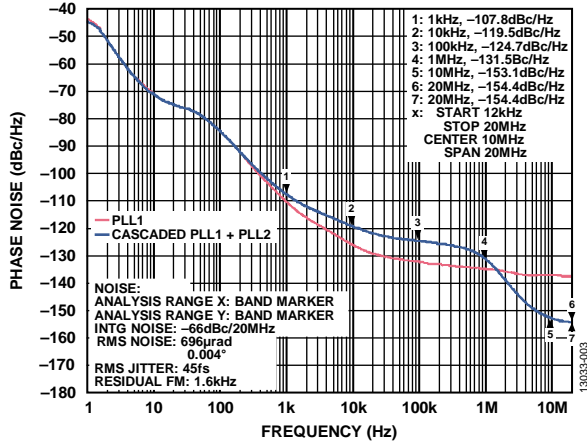

Figure 3. Cascaded Phase Noise at 2457.6 MHz, PLL2 Wide Loop Bandwidth

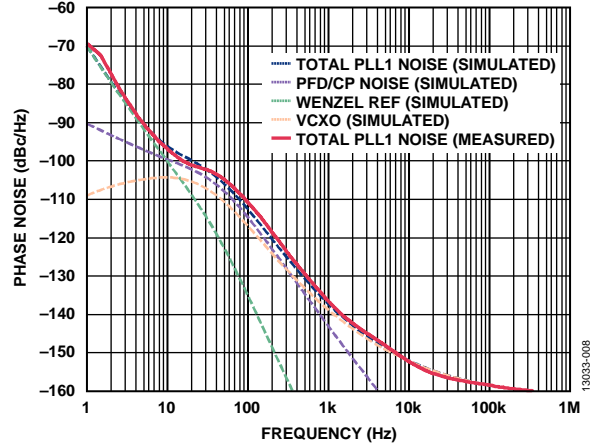

Figure 6. Closed-Loop Phase Noise at 122.88 MHz, PLL1 Measurement vs. Simulated, Clean Reference Source, ~70 Hz Loop Bandwidth 80° Phase Margin

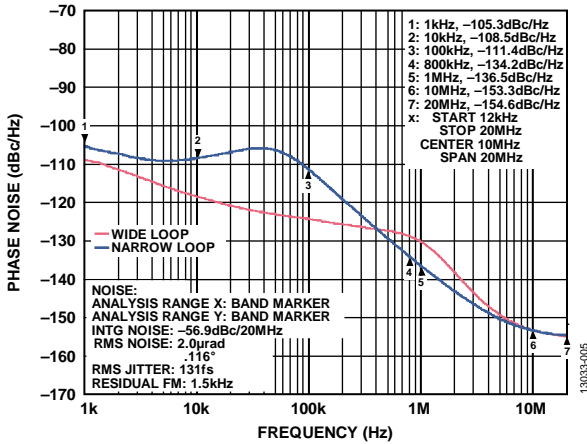

Figure 4. Phase Noise at 2457.6 MHz, Narrow vs. PLL2 Wide Loop Bandwidth

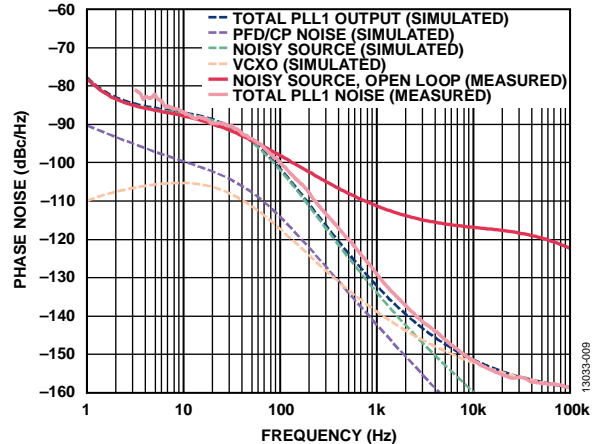

Figure 7. Closed-Loop Phase Noise at 122.88 MHz, PLL1 Measurement vs. Simulated, Noisy Reference Source, ~70 Hz Loop Bandwidth, 80° Phase Margin

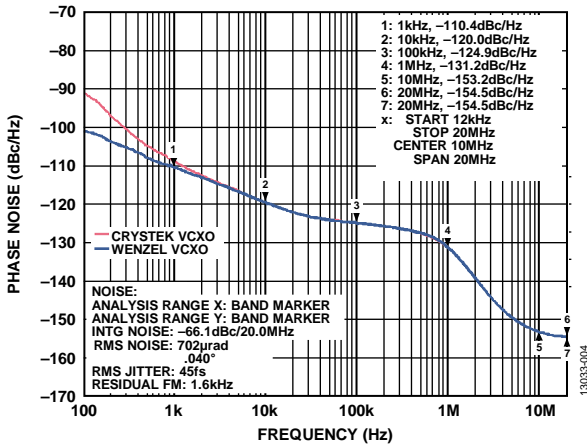

Figure 5. PLL2 Phase Noise vs. Frequency, VCXO Quality at 2457.6 MHz, Wide Loop Bandwidth

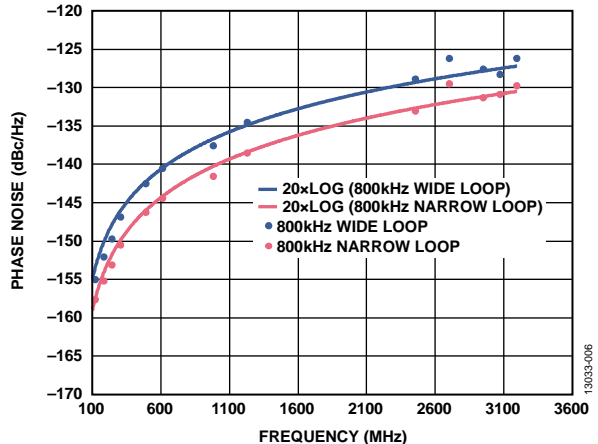

Figure 8. Phase Noise vs. Frequency at Common Output Frequencies

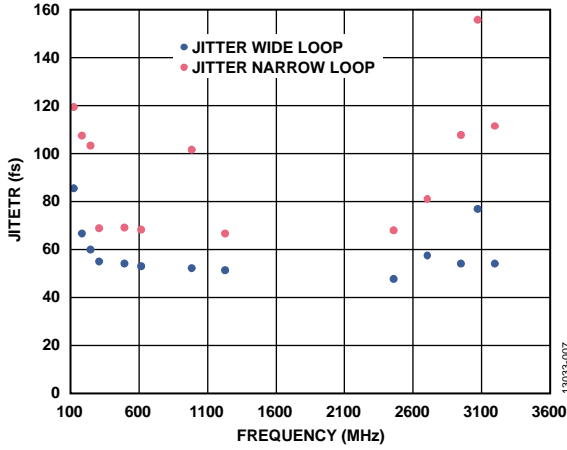

Figure 9. 12 kHz to 20 MHz Jitter vs. Frequency, Wide Loop and Narrow Loop at Common Output Frequencies

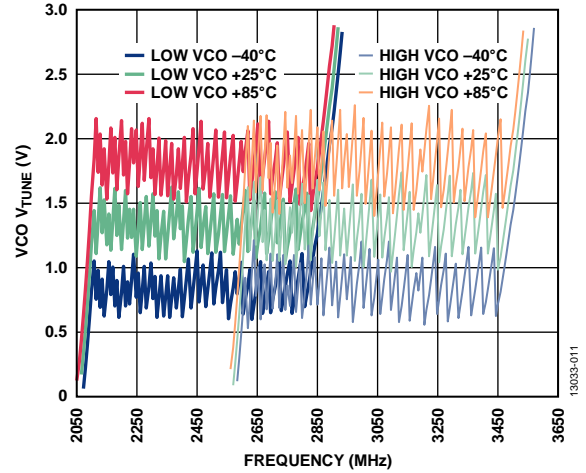

Figure 12. VCO  $V_{TUNE}$  vs. Frequency

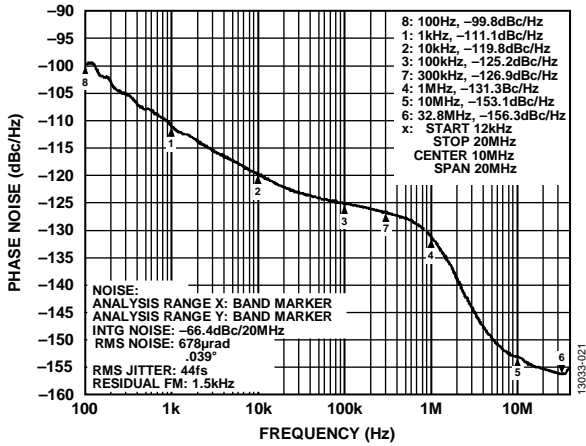

Figure 10. Phase Noise,  $\overline{CLKOUTx}/\overline{CLKOUTx} = 2457.6$  MHz, Optimized for Best Integrated Jitter (12 kHz to 20 MHz)

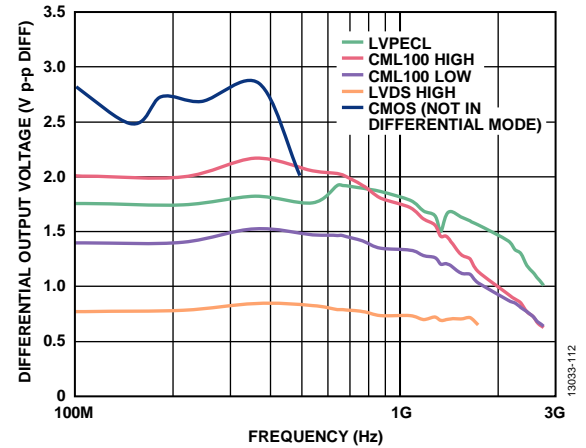

Figure 13. Differential Output Voltage vs. Frequency at Different Modes

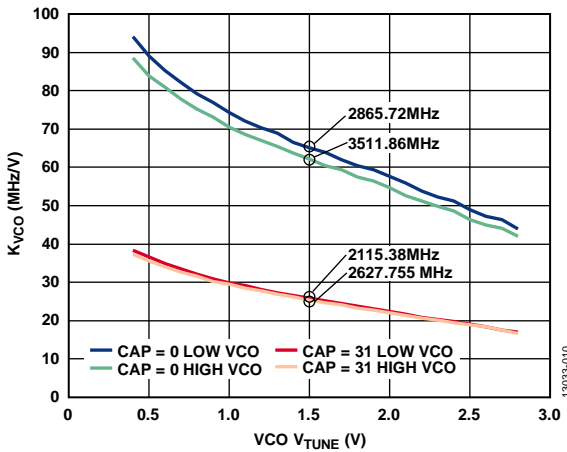

Figure 11. VCO Gain ( $K_{VCO}$ ) vs. VCO  $V_{TUNE}$

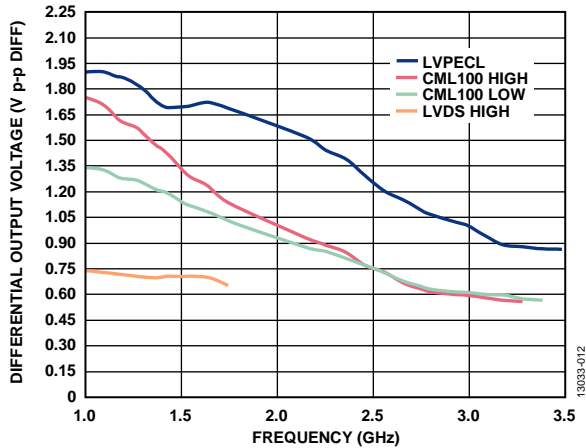

Figure 14. Differential Output Voltage vs. Frequency at Different Modes

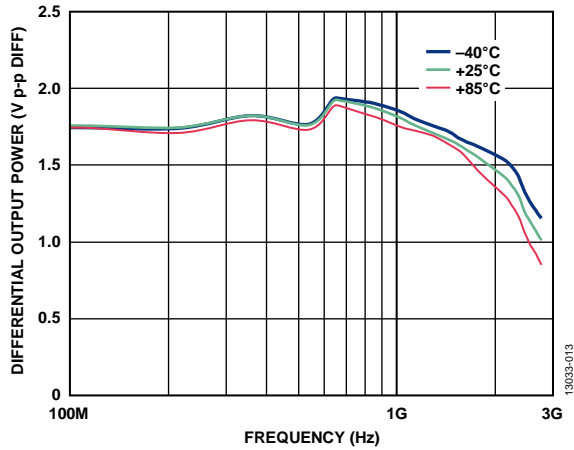

Figure 15. LVPECL Differential Output Voltage vs. Frequency at Different Temperatures

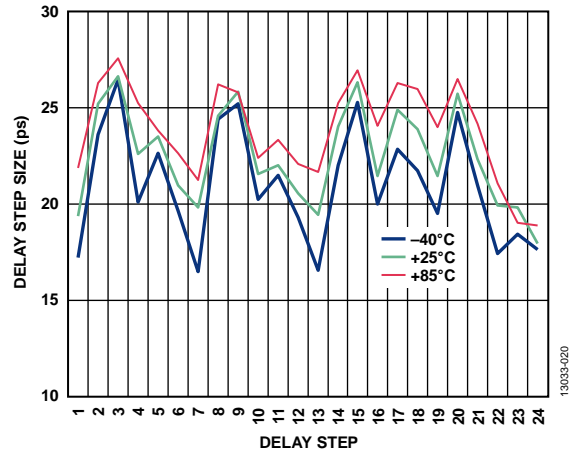

Figure 18. Analog Delay Step Size vs. Delay Step over Temperature, LVPECL at 1474.56 MHz

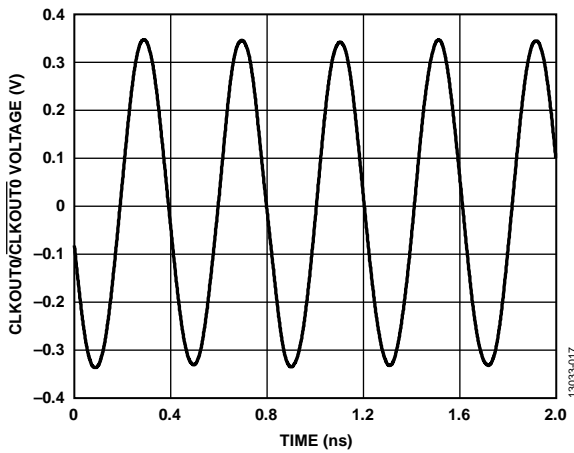

Figure 16. Differential CLKOUT0/CLKOUT0 at 2457 MHz, LVPECL

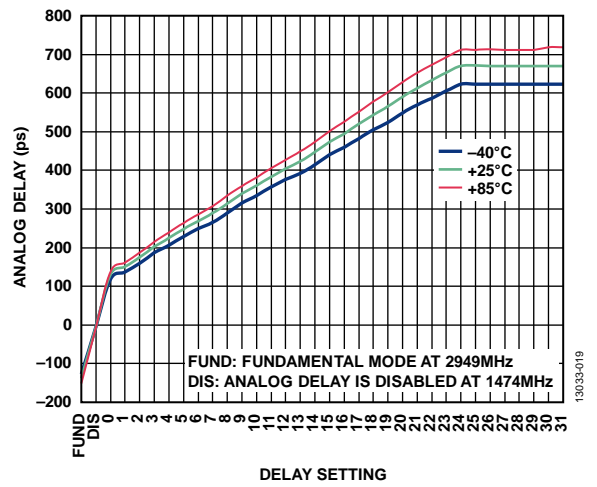

Figure 19. Analog Delay vs. Delay Setting over Temperature, LVPECL at 1474.56 MHz

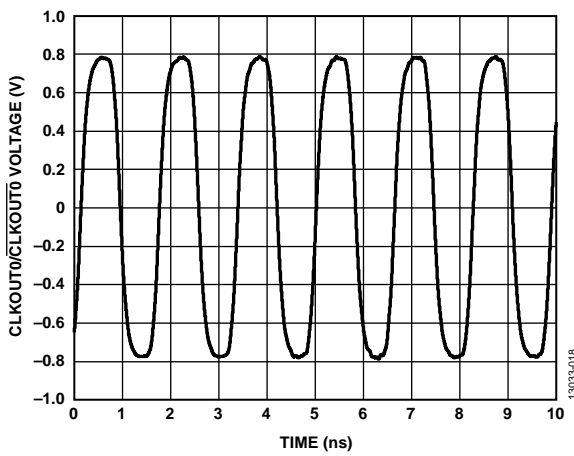

Figure 17. Differential CLKOUT0/CLKOUT0 Voltage at 614.4 MHz, LVPECL

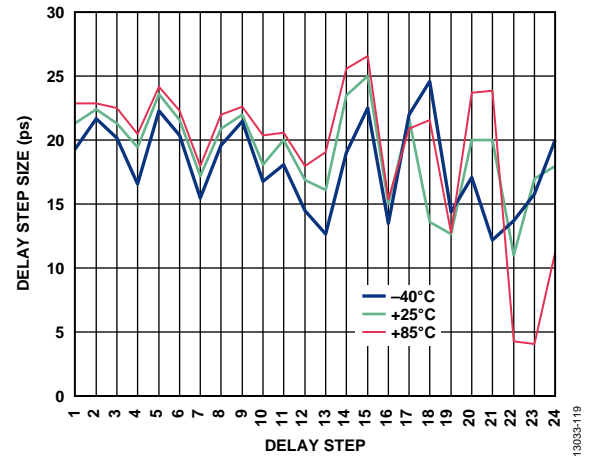

Figure 20. Analog Delay Step Size vs Delay Step over Temperature, LVPECL at 3072 MHz with Digital Delay = 0

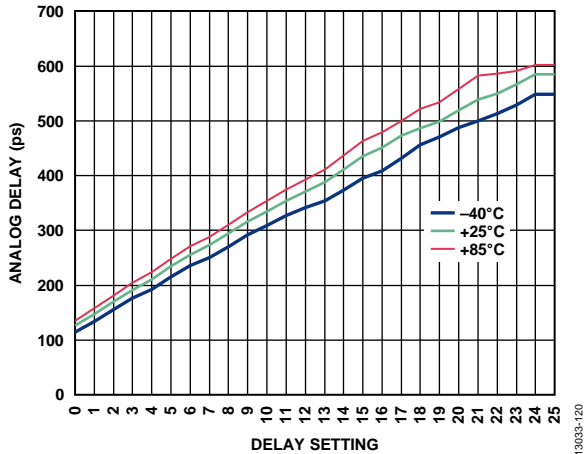

Figure 21. Analog Delay vs. Delay Setting over Temperature, LVPECL at 3072 MHz with Digital Delay = 0

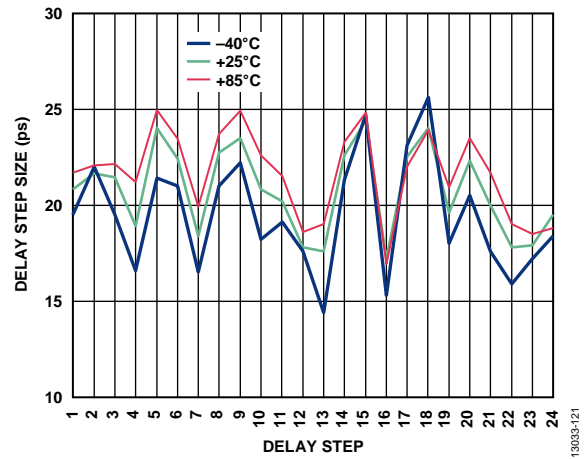

Figure 22. Analog Delay Step Size vs Delay Step over Temperature, LVPECL at 3072 MHz with Digital Delay = 1

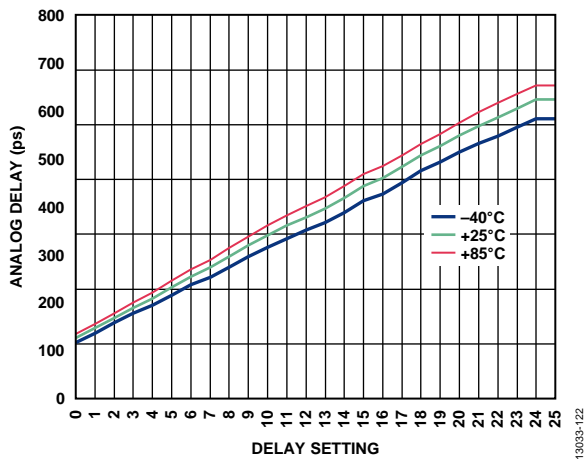

Figure 23. Analog Delay vs. Delay Setting over Temperature, LVPECL at 3072 MHz with Digital Delay = 1

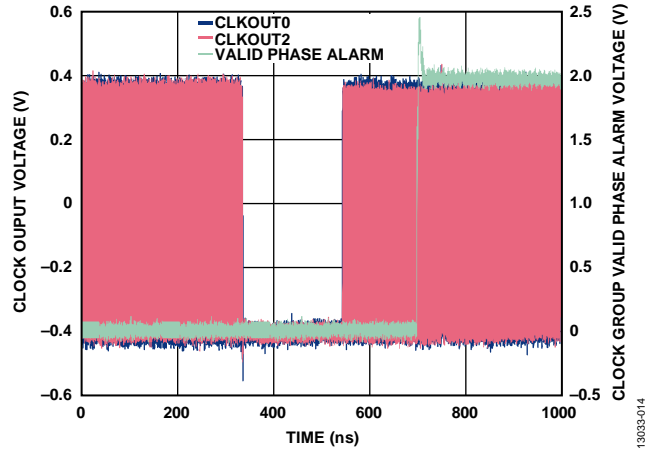

Figure 24. Output Channel Synchronization Before and After Rephase

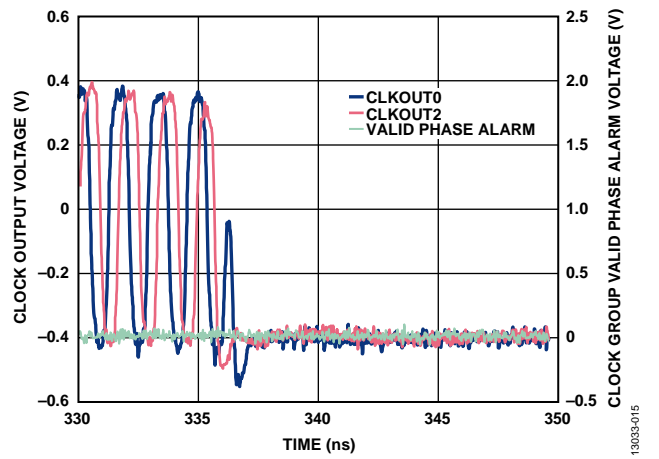

Figure 25. Output Channel Synchronization Before Rephase

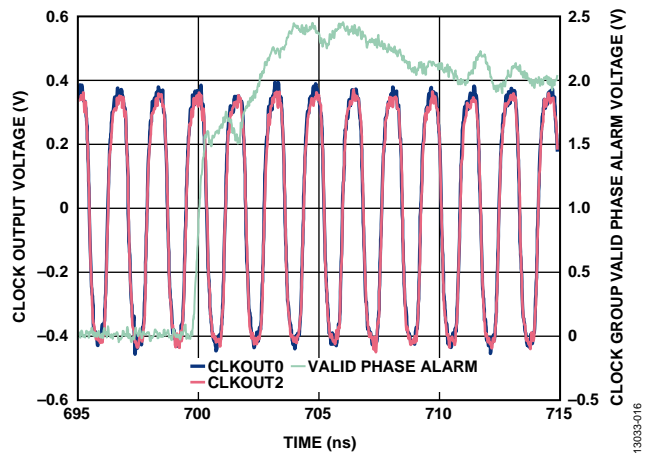

Figure 26. Output Channel Synchronization After Rephase

# TYPICAL APPLICATION CIRCUITS

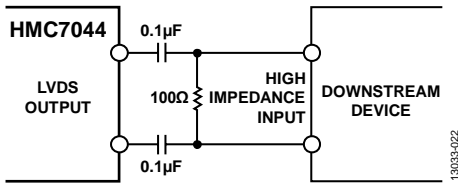

Figure 27. AC-Coupled LVDS Output Driver

130033-022

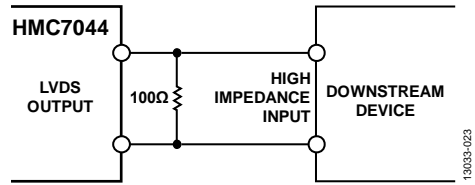

Figure 31. DC-Coupled LVDS Output Driver

130033-023

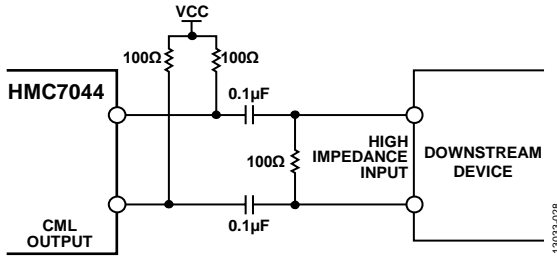

Figure 28. AC-Coupled CML (Configured High-Z) Output Driver

130033-028

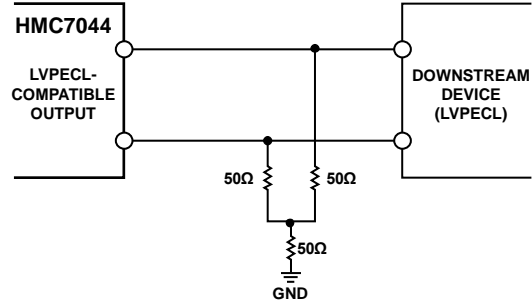

Figure 32. DC-Coupled LVPECL Output Driver

130033-025

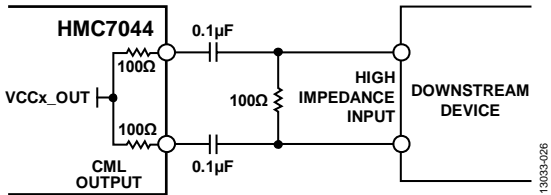

Figure 29. AC-Coupled CML (Internal) Output Driver

130033-026

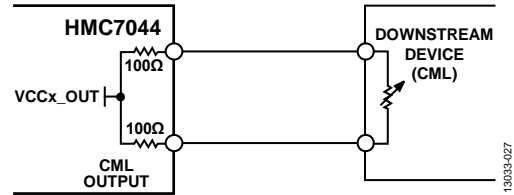

Figure 33. DC-Coupled CML (Internal) Output Driver

130033-027

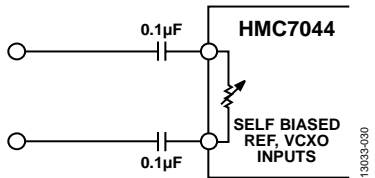

Figure 30. CLKIN0/ $\overline{\text{CLKIN0}}$ , CLKIN1/ $\overline{\text{CLKIN1}}$ , CLKIN2/ $\overline{\text{CLKIN2}}$ , CLKIN3/ $\overline{\text{CLKIN3}}$ , and OSCIN/ $\overline{\text{OSCIN}}$  Input, Differential Mode

130033-030

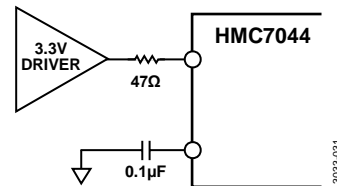

Figure 34. CLKIN0, CLKIN1, CLKIN2, CLKIN3, and OSCIN Input, Single-Ended Mode

130033-031

## TERMINOLOGY

### Phase Jitter

An ideal sine wave can be thought of as having a continuous and even progression of phase with time from 0° to 360° for each cycle. Actual signals, however, display a certain amount of variation from ideal phase progression over time. This phenomenon is phase jitter. Although many causes can contribute to phase jitter, one major cause is random noise, which is characterized statistically as being Gaussian (normal) in distribution.

This phase jitter leads to the energy of the sine wave in the frequency domain spreading out, producing a continuous power spectrum. This power spectrum is usually reported as a series of values whose units are dBc/Hz at a given offset in frequency from the sine wave (carrier). The value is a ratio (expressed in decibels) of the power contained within a 1 Hz bandwidth with respect to the power at the carrier frequency. For each measurement, the offset from the carrier frequency is also given.

### Phase Noise

It is meaningful to integrate the total power contained within some interval of offset frequencies (for example, 10 kHz to 10 MHz). This is the integrated phase noise over that frequency offset interval and can be readily related to the time jitter due to the phase noise within that offset frequency interval.

Phase noise has a detrimental effect on the performance of ADCs, DACs, and RF mixers. It lowers the achievable dynamic range of the converters and mixers, although they are affected in somewhat different ways.

### Time Jitter

Phase noise is a frequency domain phenomenon. In the time domain, the same effect is exhibited as time jitter. When observing

a sine wave, the time of successive zero crossings varies. In a square wave, the time jitter is a displacement of the edges from their ideal (regular) times of occurrence. In both cases, the variations in timing from the ideal are the time jitter. Because these variations are random in nature, the time jitter is specified in seconds root mean square (rms) or 1 sigma of the Gaussian distribution.

Time jitter that occurs on a sampling clock for a DAC or an ADC decreases the signal-to-noise ratio (SNR) and dynamic range of the converter. A sampling clock with the lowest possible jitter provides the highest performance from a given converter.

### Additive Phase Noise

Additive phase noise is the amount of phase noise that is attributable to the device or subsystem being measured. The phase noise of any external oscillators or clock sources is subtracted, which makes it possible to predict the degree to which the device impacts the total system phase noise when used in conjunction with the various oscillators and clock sources, each of which contributes its own phase noise to the total. In many cases, the phase noise of one element dominates the system phase noise. When there are multiple contributors to phase noise, the total is the square root of the sum of squares of the individual contributors.

### Additive Time Jitter

Additive time jitter is the amount of time jitter that is attributable to the device or subsystem being measured. The time jitter of any external oscillators or clock sources is subtracted, which makes it possible to predict the degree to which the device impacts the total system time jitter when used in conjunction with the various oscillators and clock sources, each of which contributes its own time jitter to the total. In many cases, the time jitter of the external oscillators and clock sources dominates the system time jitter.

## THEORY OF OPERATION

The [HMC7044](#) is a high performance, dual-loop, integer N jitter attenuator capable of performing frequency translation, reference selection, and generation of ultralow phase noise references for high speed data converters with either parallel or serial (JESD204B type) interfaces. The device is designed to meet the requirements of demanding base station designs, and offers a wide range of clock management and distribution features to simplify baseband and radio card clock tree designs.

The [HMC7044](#) uses a dual-loop architecture, where two integer mode PLLs are connected in series to form a jitter attenuating clock multiplier unit. The high performance dual-loop topology of the [HMC7044](#) enables the wireless/RF system designer to attenuate the incoming jitter of a primary system reference clock (for example, Common Public Radio Interface™ (CPRI) source) and generate low phase noise, high frequency clocks to drive data converter sample clock inputs. The [HMC7044](#) provides 14 low noise and configurable outputs to offer flexibility in interfacing with many different components in an RF transceiver system, such as data converters, local oscillators, transmit/receive modules, FPGAs, and digital front-end (DFE) ASICs.

The first PLL in the [HMC7044](#) is designed for low bandwidth configuration using appropriately selected external loop filter components, and internal charge pump bias settings to achieve less than a few hundred Hz bandwidth, typically. The exact bandwidth roll-off points depend on the frequency spectrum of noise that must be attenuated in the system. The first PLL locks an external VCXO and provides the clock holdover functions and the reference frequency to the high performance second PLL loop. The combination of the loops provides an excellent clock generation unit with the capability to attenuate incoming reference clock jitter. The second PLL loop features two overlapping on-chip VCOs that are SPI selectable with center frequencies at 2.5 GHz and 3 GHz, respectively. Both VCOs are designed to have wide tuning ranges for broad output frequency coverage. The desired output frequency is set by the chosen VCXO frequency, VCO core (higher or lower frequency core), and the programmed second PLL feedback divider and output channel divider values.

The [HMC7044](#) generates up to seven DCLK and SYSREF clock pairs per the JESD204B interface requirements. The system designer can generate a lower number of DCLK and SYSREF pairs, and configure the remaining output signal paths as desired, either as DCLKs or additional SYSREFs or other reference clocks with independent phase and frequency adjustment. Frequency adjustment can be accomplished by selecting the appropriate output divider values. One of the unique features of the [HMC7044](#) is the independent flexible phase management of each of the 14 channels. Using a combination of divider slip-based, digital/coarse and analog/fine delay adjustments, each channel can be

programmed to have a different phase offset. The phase adjustment capability allows the designer to offset board flight time delay variations, data converter sample window matching, and meet JESD204B synchronization challenges. The output signal path design of the [HMC7044](#) is implemented to ensure both linear phase adjustment steps and minimal noise perturbation when phase adjustment circuits are turned on.

One of the key challenges in JESD204B system design is ensuring the synchronization of data converter frame alignment across the system, from the FPGA or DFE to ADCs and DACs through a large clock tree that can comprise multiple clock generation and distribution ICs. The [HMC7044](#) is specifically designed to offer features to address this challenge. Using the SYSREF valid interrupt feature, the wait time latency can be reduced in the FPGAs. The [HMC7044](#) raises this flag through its GPO port when all counters are set and outputs are at the desired phases. Additionally, an external reference-based synchronization feature (SYNC via PLL2 or RF SYNC only in fanout mode) synchronizes multiple devices, that is, it ensures that all clock outputs start with same rising edge. This operation is achieved by rephasing the SYSREF control unit deterministically, and then restarting the output dividers with this new desired phase.

Offering excellent crosstalk, frequency isolation, and spurious performance, the device generates independent frequencies in both single-ended and differential formats. The four input reference options allows up to three backup frequency sources, with hitless switching and holdover capabilities, supporting system redundancy and uninterrupted operation on reference data and clock failures. The device also features dedicated oscillator fanout mode for best clock isolation, which generates multiple copies of the VCXO clock to be distributed across the board with excellent frequency isolation.

Both the DCLK and SYSREF clock outputs can be configured to support different signaling standards, including CML, LVDS, LVPECL, and LVCMOS, and different bias conditions to offset varying board insertion losses. The outputs can also be programmed for ac or dc coupling and 50  $\Omega$  or 100  $\Omega$  internal and external termination options.

The [HMC7044](#) is programmed via a 3-wire serial port interface (SPI) and powers up with a default configuration that generates valid output frequencies within the VCO tuning ranges regardless of whether a reference clock exists.

The [HMC7044](#) is offered in a 68-lead, 10 mm  $\times$  10 mm, LFCSP package with the exposed pad to ground.

Note that, throughout this data sheet, multifunction pins, such as CLKIN0/RFSYNCIN, are referred to either by the entire pin name or by a single function of the pin, for example, CLKIN0, when only that function is relevant.

DETAILED BLOCK DIAGRAM

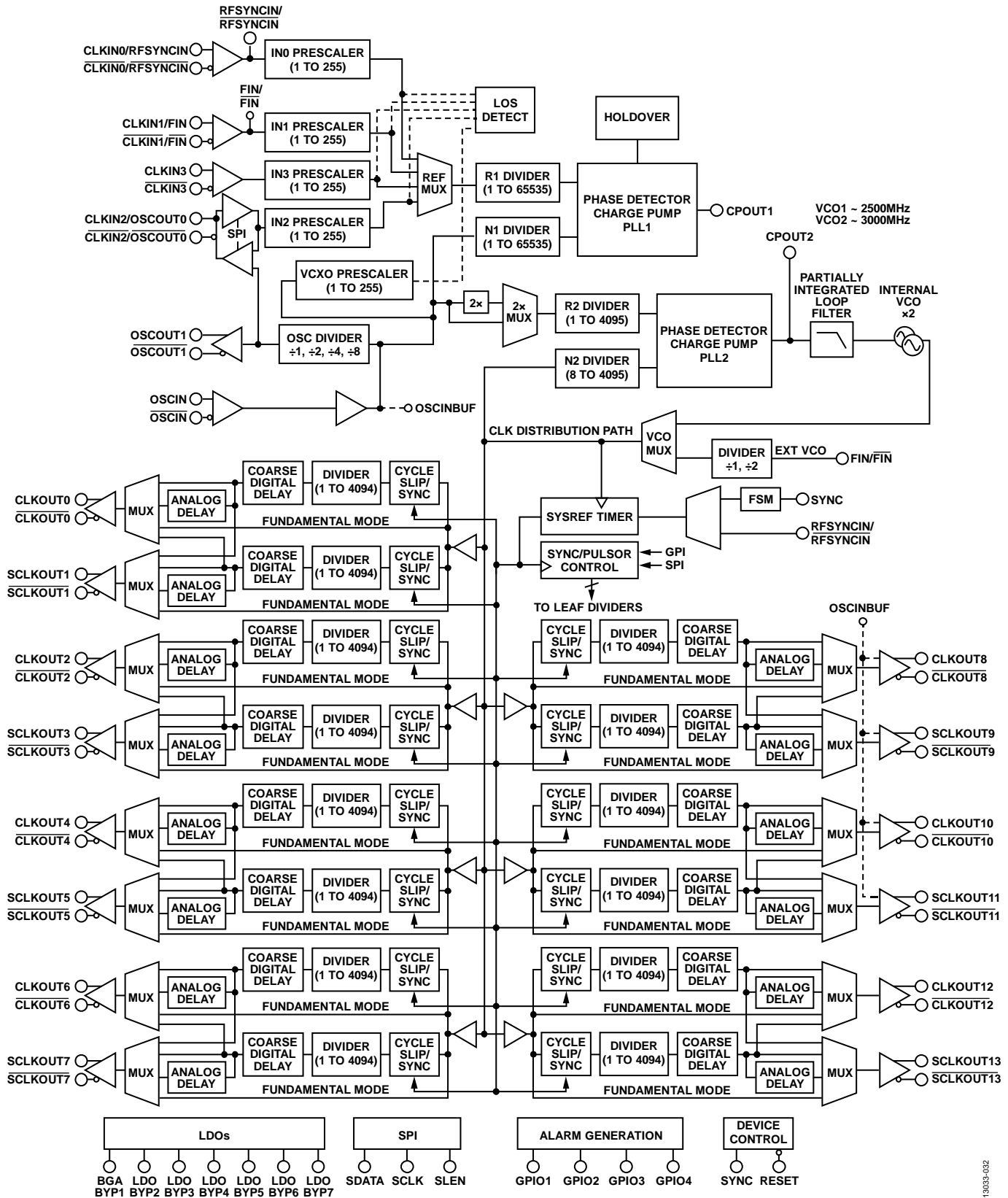

Figure 35. Top Level Diagram



## DUAL PLL OVERVIEW

The HMC7044 uses a cascade of two PLLs, referred to as a dual loop topology. The term dual loop sometimes refers to other architectures as well; therefore, always refer to the block diagram shown in Figure 35 to remove any ambiguity. In this architecture, the first PLL (PLL1) normally operates as a jitter attenuator. PLL1 locks a clean local VCXO to a relatively noisy reference using a very narrow loop bandwidth. The loop bandwidth preserves the average frequency of the reference signal (which is normally correct), while rejecting the majority of its noise. The second PLL takes this low noise VCXO and multiplies it up to the VCO frequency (in the 2 GHz to 3 GHz range) with very little additive noise. The architecture provides the benefits of an output frequency locked to an input reference signal, while being insensitive to its noise profile.

In ICs such as the HMC7044, the VCO is then connected to an array of output channels, each with an optional RF divider and phase control. The key feature that distinguishes an IC with JESD204B support is the ability to ensure that all of the outputs with their associated dividers have a user defined phase relationship each and every time, regardless of process, voltage, or temperature. This ability is necessary to support the JESD204B SERDES standard for data converters, but it is also an immensely useful feature in other applications as well, in all forms of arrayed systems and in many test and measurement scenarios.

## COMPONENT BLOCKS—INPUT PLL (PLL1)

### PLL1 General Description (Jitter Attenuator)

A variety of local clocks, particularly in synchronous networks, derive their timing from a remote node in the network. These reference signals can arrive via a GPS or clock data recovery (CDR) receiver, or from a variety of other sources. Often, these derived references are relatively poor quality, in terms of spurious content, noise, and reliability.

The function of PLL1 is to lock a clean VCXO to the average frequency of one of these references and feed it to PLL2 to generate a high quality clock for local use.

In addition, PLL1 monitors its active reference for failure and smoothly takes appropriate action, switching to a redundant reference or going into holdover as appropriate. Figure 36 shows the architecture of PLL1 with a typical frequency configuration.

### Jitter Attenuation

For the purpose of jitter attenuation, PLL1 consists of all the usual components in a PLL: a phase/frequency detector (PFD1), charge pump (CP1), reference divider (R1), and feedback divider (N1). The loop filter is external to provide maximum flexibility, and the loop bandwidth (BW) is normally configured very narrow (20 Hz to 500 Hz) to filter any jitter and spurious tones coming in from relatively poor references.

The noise profile of PLL1 is typically dependent on the loop bandwidth, input reference noise, and the VCXO characteristic. The inherent noise sources of PLL1 (the PFD, dividers, and charge pump) are not normally observable in an application, and are significantly more relaxed compared with PLL2.

Note that the loop filter components on the board are typically configured to produce a certain loop bandwidth, given a fixed PFD rate, charge pump current, and VCXO characteristic. Adjusting any of these parameters from their nominal positions affects the loop dynamics, which can be to the advantage of the user (for example, to scale loop BW with charge pump current), but it must not be performed without an analysis of the stability of the loop. Analog Devices, Inc., provides a variety of software tools to design the loop filter and model the effects of any change in parameters. Contact Analog Devices for the latest recommendation.

The lock time of PLL1 typically takes the longest duration in the clock network, and, aside from any nonlinear slewing, takes approximately  $5/\text{PLL1\_BW}$  (for example, 5 ms for a 1 kHz loop BW). Fortunately, there are no requirements that PLL1 must be locked before proceeding with PLL2, output calibration, and phasing, which normally allows system configuration to continue in parallel while PLL1 is settling.



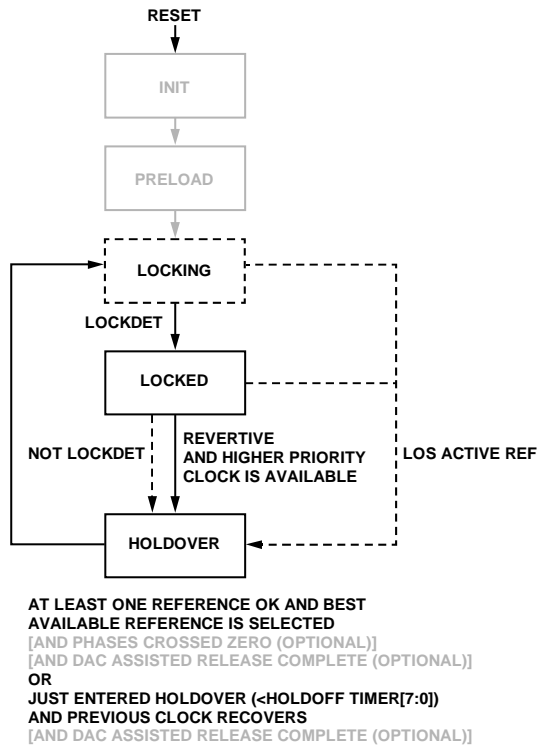

Figure 37. PLL1 FSM Simplified State Diagram—  
Autorevertive Reference Switching = 1

### PLL1 Reference Inputs

PLL1 accepts up to four candidate references on  $\overline{\text{CLKIN3}}$ /CLKIN3 to CLKIN0/ $\overline{\text{CLKIN0}}$ . If all references appear valid, according to the LOS, PLL1 uses a reference priority table to select the best candidate. Using the PLL1 reference priority control bits, program the highest priority clock ( $\overline{\text{CLKIN0}}$ /CLKIN0, CLKIN1/ $\overline{\text{CLKIN2}}$ , CLKIN2/ $\overline{\text{CLKIN2}}$ , or CLKIN3/ $\overline{\text{CLKIN3}}$ ), and then second priority clock, and so on. It is not necessary to include unused reference inputs in the reference priority table. Instead, specify the same useful clock in multiple positions. In automode, reference switching occurs in the preload state (see Figure 37) as PLL1 exits reset, or while PLL1 is in the holdover state.

The reference clock input pins (Pin 36, Pin 37, Pin 39, Pin 40, Pin 42, and Pin 43) have dual functions; therefore, SPI configuration is important for proper functionality. See the PLL1 Programming Considerations section for more information about the relevant control bits, and the Reference Buffer Details section for interface recommendations.

When a reference fails, the sourcing circuit recognizes a fault and disables either the clock or the buffer driving the signal to the HMC7044. For this reason, hysteresis in the input buffers prevents internal toggling for signal swings  $< \sim 75$  mV p-p differential, which allows further elements in the PLL1 architecture to cleanly recognize the interruption and prevent unwanted transients in the frequency.

### PLL1 LOS Detection

The HMC7044 checks the validity of a reference by comparing its approximate frequency vs. the VCXO. The HMC7044 supports references at different frequencies. The first step is to divide the available references and the VCXO to the lowest common multiple frequency ( $f_{\text{LCM}}$ ). These divider settings are available via the SPI control bits (CLKINx/CLKINx Input Prescaler[7:0] and OSCIN/ $\overline{\text{OSCIN}}$  Input Prescaler[7:0]). In the example shown in Figure 36,  $f_{\text{LCM}} = 61.44$  MHz. The VCXO derived clock at  $f_{\text{LCM}}$  is the main clock to the PLL1 FSM controlling the FSM, lock detect timer, and ADC/DAC filtering and holdover circuits. Although not required, using the VCXO clock allows the LOS detection and PLL1 FSM to operate at a higher rate than the PFD, allowing it to recognize a reference failure early and enter holdover, sometimes before a failing reference that has started to drift in either phase or frequency (or both) can influence the PFD or CP.

The dividers in the LOS block, and to some extent, R1, pose a few challenges. The input frequencies are up to 800 MHz, with a wide divider range. Furthermore, they are designed to tolerate glitchy clocks without catastrophic results, because a reset phase is not always available after an issue is detected.

When all the references are divided to the same frequency, they are compared relative to the VCXO derived path, and thus each other. This comparison is performed by a circuit that looks for three edges of a clock within one period of the other. If it appears that a reference signal is too slow, its LOS flag is asserted and, in automode, PLL1 uses this information to disqualify and/or abandon a reference. Conversely, if it appears that the VCXO is too slow according to any of the active references, a warning is generated (available as one of the configurable options for the GPO, or readable on the SPI) but no automated action occurs.

The HMC7044 monitors reference signals for three edges of a clock within one period of the other, instead of the more intuitive two edges, to avoid false LOS flags as clocks that are slightly out of frequency cross each other in phase in the presence of interference, noise, and circuit offsets. The result is that the LOS triggers when the failing reference clock frequency is approximately an octave from the intended frequency.

After a reference signal returns and its frequency is within an octave of the VCXO, two to three cycles of the LOS validation timer must expire before the LOS flag is deasserted and the reference is considered for potential use. The LOS validation timer is programmable between 0 LCM cycles (no hysteresis), and 64 LCM cycles via LOS Validation Timer[2:0] in Register 0x0015, Bits[2:0].

### PLL1 Holdover Entry Shortcut

When a reference fails, the LOS circuit takes a number of LCM clock cycles to recognize the problem and to request the PLL1 FSM enter holdover and tristate the CP. By that time, if one of the missing edges is needed to trigger the R divider output, the PFD and CP have already saturated, pulling current out of the loop filter for these cycles, and disturbing the holdover frequency. The probability of this happening decreases as the PFD rate decreases relative to  $f_{LCM}$ , but it is not eliminated. The HMC7044 includes a unique feature to prevent this type of frequency runaway.

A sensor watches the up/down pulses from the PFD (see Figure 35). When locked, the pulse width is small, based on any small signal error, PFD/CP offset, and the reset delay of the PFD. If the device is in the locked state and has a phase error that is larger than expected ( $\sim 4$  ns), it is a sign that the reference has failed, and the device immediately trisates the pump, reducing the amount of time charge can be extracted from the loop from about five LCM cycles (162 ns at 30.72 MHz) to  $< 4$  ns. This error indication also invalidates the lock detect. When the FSM acknowledges the issue, it holds the CP in tristate. When using the optional DAC-based holdover, the FSM instructs the ADC/DAC that is tracking the  $V_{TUNE}$  voltage to switch from sense mode to force mode, holding it steady to within 1 LSB (about 20 mV or 0.4 ppm) until the HMC7044 senses a stable reference and transitions out of holdover.

### PLL1 Holdover Steady State

When in the holdover state, the user has the following two options:

- Tristate the CP
- Tristate the CP and engage the holdover DAC

When in tristate mode, the HMC7044 has a very high impedance charge pump output ( $\sim 10$  G $\Omega$ ). This output is normally an insignificant contributor to PLL1  $V_{TUNE}$  leakage, which is determined primarily by the on-board loop filter components and the VCXO tuning port. This mode allows the tuning voltage to maintain itself for significant periods while in holdover.

To accommodate indefinite periods in holdover, or to ensure  $V_{TUNE}$  is driven and not susceptible to drift, the second option (set via the holdover uses DAC bit in Register 0x0029, Bit 2) forces the  $V_{TUNE}$  voltage to its time averaged value, obtained by low-pass filtering the ADC value while the PLL is reporting lock. The holdover sensing ADC and the driving DAC are seven bits each, and have an LSB of approximately 19 mV.

### PLL1 Holdover Exit

The transition out of holdover can happen in three ways and is controlled by the Holdover Exit Criteria[1:0] bits and the Holdover Exit Action[1:0] bits in Register 0x0016 (see the Control Register Map Bit Descriptions section for details), which describes the steps that the FSM takes as the HMC7044 exits holdover and acquires lock.

The recommended methods are as follows:

- Wait for zero phase error (no divider reset): wait for LOS = 0 and low phase error at PFD (Holdover Exit Criteria[1:0] = 1, Holdover Exit Action[1:0] = 1)
- Resetting the dividers: wait for LOS = 0 and reset the R1/N2 dividers (Holdover Exit Criteria[1:0] = 0, Holdover Exit Action[1:0] = 0)
- DAC assisted release: wait for LOS = 0, reset R1/N2, and configure for DAC assisted release (Holdover Exit Criteria[1:0] = 0, Holdover Exit Action[1:0] = 3)

### Wait for Zero Phase Error

While the CP is still in tristate, the FSM monitors the PDF for a cycle slip indication as the candidate reference and VCXO signal cross each other. The crossing of the reference and VCXO phases eventually occurs but can take a long time, as determined by the inherent frequency error due to an imperfect holdover. Just after a cycle slip event, the phase error at the PFD is at its minimum value, and there is minimal glitch as the PLL reacquires. Figure 38 shows an example where the reference is removed and PLL1 goes into tristate-based holdover. After approximately 7 sec, the reference is restored and, about a second later, the phases cross and the PLL reacquires, all with less than 0.15 ppm of deviation from the original frequency value.

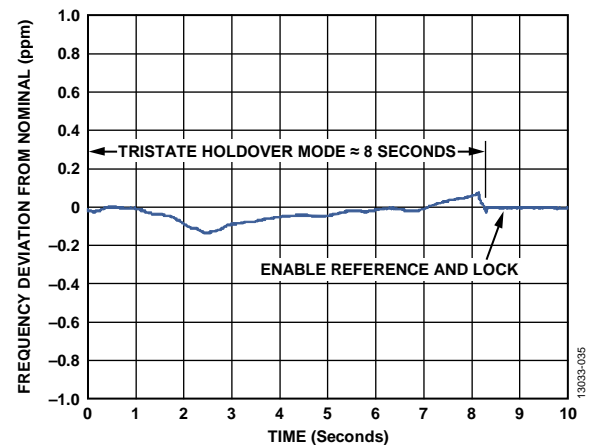

Figure 38. Frequency Deviation from Nominal vs. Time of Tristate Holdover Entry and Exit When the Phases Cross Zero

This first method of uncontrolled release suffers from an indeterminate amount of time for the phases to cross and exit holdover. However, if it takes 1 sec for the phases to cross, the frequencies are off by only 1 Hz. If it takes 10 sec to cross, the error is 0.1 Hz. If the error is so low that it takes a long time to exit holdover, the device is effectively frequency locked. In some applications, being open-loop for this long of a duration can be acceptable, considering the very small frequency errors. Although this method of holdover exit is very smooth, it can take a very long time to occur.

**Resetting the Dividers**

If using tristate-based holdover, the second holdover exit method is recommended. When a reference appears available (LOS = 0), the FSM resets the R and N dividers and allows them to restart immediately. This approach limits the maximum phase error coming out of holdover to two VCXO cycles (about 8 ns for typical VCXO frequencies). There is no need to wait an undetermined amount of time (as in the first method of uncontrolled release) to initiate the switch.

**DAC Assisted Release**

If using DAC-based holdover, the DAC and CP can set  $V_{TUNE}$  concurrently as the device exits holdover. With the DAC output impedance at a relatively low setting (for example,  $5\ \Omega$ ), the device resets the dividers as in the second method, and then the CP attempts to influence  $V_{TUNE}$ . The CP fails, with the DAC sinking the current it is trying to inject into the  $V_{TUNE}$  node. Gradually, the device increases the output impedance of the DAC, and the CP gains more influence to manipulate  $V_{TUNE}$ , pulling the phases into alignment. Using this DAC assisted CP release method limits the holdover exit transients to within  $\sim 1$  ppm.

Figure 39 to Figure 41 compare the holdover release methods: resetting the dividers vs. DAC assisted release, and uncontrolled release (which starts with a phase error of up to one PFD period) as the device exits holdover and reacquires to a reference signal.

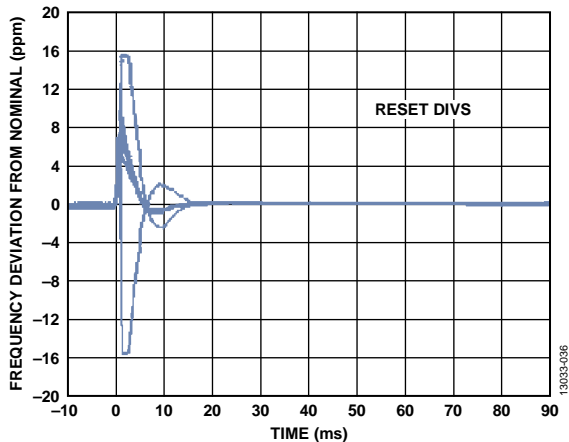

Figure 39. Resetting the Dividers

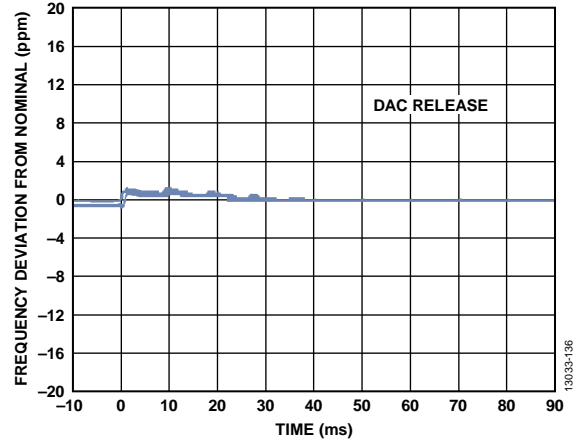

Figure 40. DAC Assisted Release

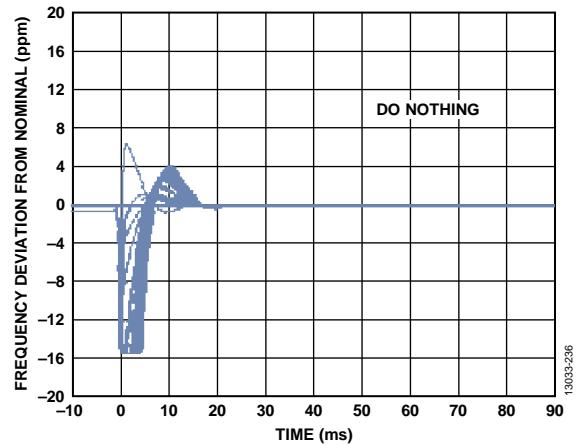

Figure 41. Wait for Zero Phase Error (No Divider Reset)

**PLL1 Programming Considerations**

**Configuring Reference Inputs for PLL1 vs. Other Uses**

To use the four reference clocks for PLL1, the input buffer must be enabled and selected as a relevant path for PLL1.

**Table 13. Input Buffer and Reference Path Settings**

Bit Name	Description
Buffer Enable	Enable the input buffer (where x = 0, 1, 2, 3, or V for VCXO) via Register 0x000A to Register 0x000E
PLL1 Reference Path Enable[3:0]	Select one of four available reference paths for PLL1

Because the  $\overline{\text{CLKIN0/RFSYNCIN}}$ ,  $\overline{\text{CLKIN0/RFSYNCIN}}$ ,  $\overline{\text{CLKIN1/FIN}}$ , and  $\overline{\text{CLKIN1/FIN}}$  pins can be configured for output network purposes, and the  $\overline{\text{CLKIN2/OSCOUT0}}$  and  $\overline{\text{CLKIN2/OSCOUT0}}$  pins can function as oscillator outputs, the SPI bits in Table 14 must be configured accordingly.

Table 14. Reference Clock Input Bit Settings

Bit Name	Description
CLKIN0/CLKIN0 In RF SYNC Input Mode	0 = CLKIN0/CLKIN0 does not function as an RF sync input
CLKIN1/CLKIN1 in External VCO Input Mode	0 = CLKIN1/CLKIN1 does not function as external VCO (FIN//FIN)
OSCOU0/OSCOU0 Driver Enable	1 = OSCOUT0/OSCOU0 buffer does not drive CLKIN2/CLKIN2 pins

### Choosing $f_{PD1}$

Although PLL1 supports a wide range of PFD frequencies, there are trade-offs with setting the frequency too high or too low. A few megahertz is high enough to allow the comparison frequency to stay at an offset outside of the PLL2 loop BW and thus suppress any coupling that manages to bypass the PLL1 loop filter.

### Choosing $f_{LCM}$

At a minimum,  $f_{LCM}$  must be a common submultiple of all available references. Typical frequencies include 122.88 MHz, 61.44 MHz, 38.4 MHz, 30.72 MHz, 3.84 MHz, and 1.92 MHz. This  $f_{LCM}$  clock is the main clock for the PLL1 digital logic. This clock rate also scales the PLL1 lock detect timer speeds/thresholds, holdover ADC averaging times, and LOS assertion and revalidation delays. Higher frequencies slightly improve the response times to reference interruptions, whereas lower frequencies can slightly reduce current consumption of the device by up to ~10 mA. Values in the 30 MHz to 70 MHz range are recommended.

Program the PLL1 lock detect timer threshold based on the PLL1 loop BW and  $f_{LCM}$  of the user.

There are reserved registers, as described in the Control Register Map Bit Descriptions section, that must be reprogrammed from their default values. For example, Register 0x00A5 must be set from 0x00 to 0x06.

## COMPONENT BLOCKS—OUTPUT PLL (PLL2)

### PLL2 Overview

PLL2 is a very low noise integer PLL designed to multiply the frequency from the VCXO to the VCO. It typically operates with a loop BW of 10 kHz to 700 kHz. Use bandwidths on the lower end of the range to preserve the inherent VCO phase noise at 800 kHz offset (useful in GSM-based systems), where bandwidths on the upper end can provide the best integrated phase noise/jitter values.

Internally, PLL2 has a number of features that allow it to efficiently achieve a Banerjee floor FOM of  $-232$  dBc and a flicker FOM of  $-266$  dBc. The combination of the on-board VCO, an internal VCXO doubler, a low N2 minimum divide ratio, and the ability to clock the PFD at up to 250 MHz results in an integrated jitter (at 12 kHz to 20 MHz) of 44.0 fs typical.

PLL2 has the following features:

- Lock detect
- Frequency doubler
- Partially integrated loop filter
- VCO selection, external VCO use
- VCO calibration
- Multichip synchronization via PLL2

### Lock Detect

The lock detect function of PLL2 behaves the same way as in PLL1. It counts the number of consecutive PFD clock cycles that occur with a low phase error. When it reaches a count of 512, it declares lock. The threshold of 512 is adjustable, but because the PLL2 loop BW does not vary as much as PLL1, it is expected that the user never needs to change this threshold.

### Frequency Doubler

The user can engage a frequency doubler after the VCXO buffer and before the reference divider (see Figure 35). The frequency doubler assumes an approximate 50% input duty cycle, where any duty cycle distortion can result in a spur, at  $f_{PD2}/2$ , suppressed by the PLL2 loop filter. Use of the frequency doubler is highly recommended to achieve the best spectral performance, provided the PFD is kept under its 250 MHz frequency limit.

### Partially Integrated Loop Filter

Although the large components for the PLL2 loop filter are off chip, there is a small on-chip resistor/capacitor (RC) section formed with  $R = 80 \Omega$  and  $C = 4.7 \text{ pF}$  in series. This RC section forms a higher order pole at  $\sim 420$  MHz. For practical conditions, this filter segment does not affect the stability of the loop.

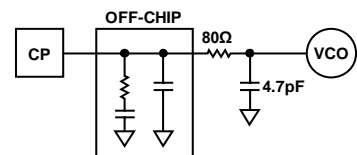

Figure 42. On-Chip RC Circuit

Figure 43 shows the VCO input network. Depending on the frequency band of interest (2.5 GHz or 3.0 GHz), the user must specify which VCO to enable via the VCO Selection[1:0] SPI word. To use the CLKIN1/FIN pin as an external VCO signal, program this word to 0, and set the CLKIN1/CLKIN1 in external VCO input mode bit.

**VCO Selection, External VCO Use**

Figure 43. VCO Input Network

**VCO Calibration**

The on-board VCOs contain an AGC loop that regulates the core voltage of the oscillator to achieve the desired swing and thus the trade-off between phase-noise and power consumption. This AGC loop uses large external bypass capacitors to eliminate the noise impact of the AGC loop, and therefore takes time to settle after power-up, sleep, or after changing the VCO Selection[1:0] setting. With the 100 nF/1  $\mu$ F configuration, settling time takes approximately 10 ms (typical).

Each of the VCOs in the HMC7044 has 32 frequency bands. Normally, three or more subbands can synthesize any particular frequency, and an on-board autotune algorithm selects the solution that provides tuning margin for temperature fluctuations. Temperature compensation is applied inside to ensure the device can be calibrated at any frequency and maintain lock as the frequency is carried to any other frequency in the operating range.

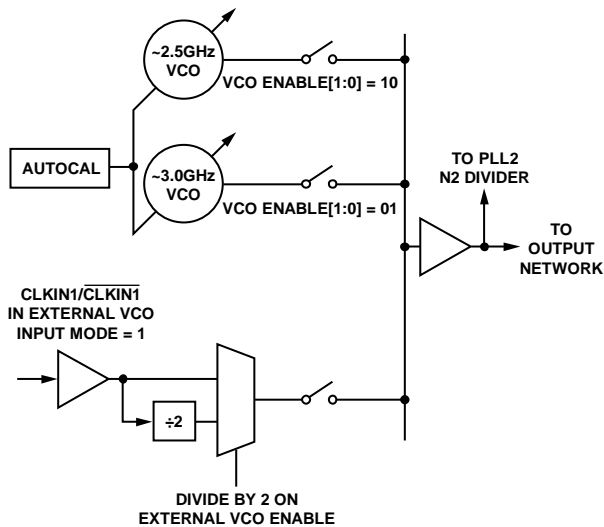
The autotune is triggered by toggling the restart dividers/FSMs bit in Register 0x0001, Bit 1, after R2 and N2 are programmed, the VCXO is applied, and the VCO peak detector loop has settled.

When the VCXO is applied to the system and the R2 and N2 divide ratios are programmed, the autotune algorithm has the information needed to find the appropriate band of the VCO.

**Multichip Synchronization via PLL2**

To synchronize multiple HMC7044 devices together, it is recommended to use the SYNC input pin. If the SYNC pin transitions from 0 to 1 with sufficient setup/hold margin with respect to the VCXO, this synchronization event is deterministically carried through PLL2, up the timing chain through the N2 divider, and then to the master SYSREF timer (see the Clock Output Network section for more information). This mechanism of deterministic phase adjustment allows synchronization of the SYSREF timer and output phases of multiple HMC7044 devices.

Apply the SYNC input rising edge only once. After sensing the rising edge on the VCXO domain, the SYNC input is ignored for the next  $16 \times 6 t_{PD2}$  periods as the FSM processes the event. After this period expires, the FSM becomes sensitive again to the SYNC pin. If the SYNC is applied periodically, the first edge initializes the synchronization process, and then the subsequent edges may or may not be recognized depending on their width/repetition rate with respect to  $16 \times 6 t_{PD2}$ .

Note that the SYNC rising edge must be provided cleanly with respect to the HMC7044 VCXO input pin (OSCIN/OSCIN). The user normally has access to the CLKINx/CLKINx pins of PLL1, and not to the VCXO signal directly. When PLL1 is locked, however, the VCXO rising edge is roughly aligned to the PLL1 active reference, and, therefore, the user has indirect knowledge of the phase of the VCXO. The VCXO is also available as an output of the HMC7044, if the user wants to retune the SYNC signal more directly.

The phase offset of the PLL1 active reference with respect to the VCXO is a function of the internal delay of each path. This base delay offset is a function of deterministic conditions (LCM, R1, N1 divider setpoints, termination setups, and slew rates), but is also subject to PVT variations that compress or exaggerate this offset.

For most practical purposes, the multichip synchronization feature is limited to PLL1 reference rates <200 MHz.

**CLOCK OUTPUT NETWORK**

In the HMC7044, PLL1 is responsible for frequency cleanup, redundancy, and hitless switching. PLL2 and the VCOs handle integrated jitter and performance at an 800 kHz offset. Although the PLL1/PLL2 and VCXO components are important, much of the uniqueness of a JESD204B clock generation chip relates to its array of output channels.

In a device such as the HMC7044, some of the output network requirements include the following:

- Very good phase noise floor of the DCLK channels that can be connected to critical data converter sample clock inputs
- A large number of DCLK and SYSREF channels
- Deterministic phase alignment between all output channels relative to one another
- Fine phase control of synchronization channels with respect to the DCLK channel
- Frequency coverage to satisfy typical clock rates in expectant systems
- Skew between SYSREF and DCLK channels that is much less than a DCLK period
- Spur and crosstalk performance that does not impact system budgets

The HMC7044 output network also supports the following recommended features, which are sometimes critical in user applications:

- Deterministic synchronization of the output channels with respect to an external signal, which allows multichip synchronization and clean expansion to larger systems
- Pulse generator behavior to temporarily generate a synchronization pulse stream at user request
- Flexibility to define unused JESD204B SYSREF and DCLK channels for other purposes
- Glitchless phase control of signals relative to each other
- 50% duty cycle clocks with odd division ratios
- Multimode output buffers with a variety of swings and termination options
- Skew between all channels that is much less than a DCLK period
- Adjustable performance vs. power consumption for less sensitive clock channels
- Flexibility to use an external VCO for very high performance application requirements

Each of the 14 output channels are logically identical. The only distinction between the SYSREF and DCLK channels is in the SPI configuration and in how they are used. Each channel contains independent dividers, phase adjustment, and analog delay circuits. This combination provides the ultimate flexibility, cleanly accommodating nonJESD204B devices in the system.

In addition to the 14 output channel dividers, there is an internal SYSREF timer that continually operates, and the synchronization of the output channel dividers occurs deterministically with respect to this timer, which can be rephased externally by the user.

The pulse generator functionality of the JESD204B standard involves temporarily generating SYSREF output pulses, with appropriate phasing, to downstream devices. The centralized SYSREF timer and its associated SYNC/pulse generator control manage the process of enabling the intended SYSREF channels, phasing them, and then disabling them for signal integrity and power saving advantages.

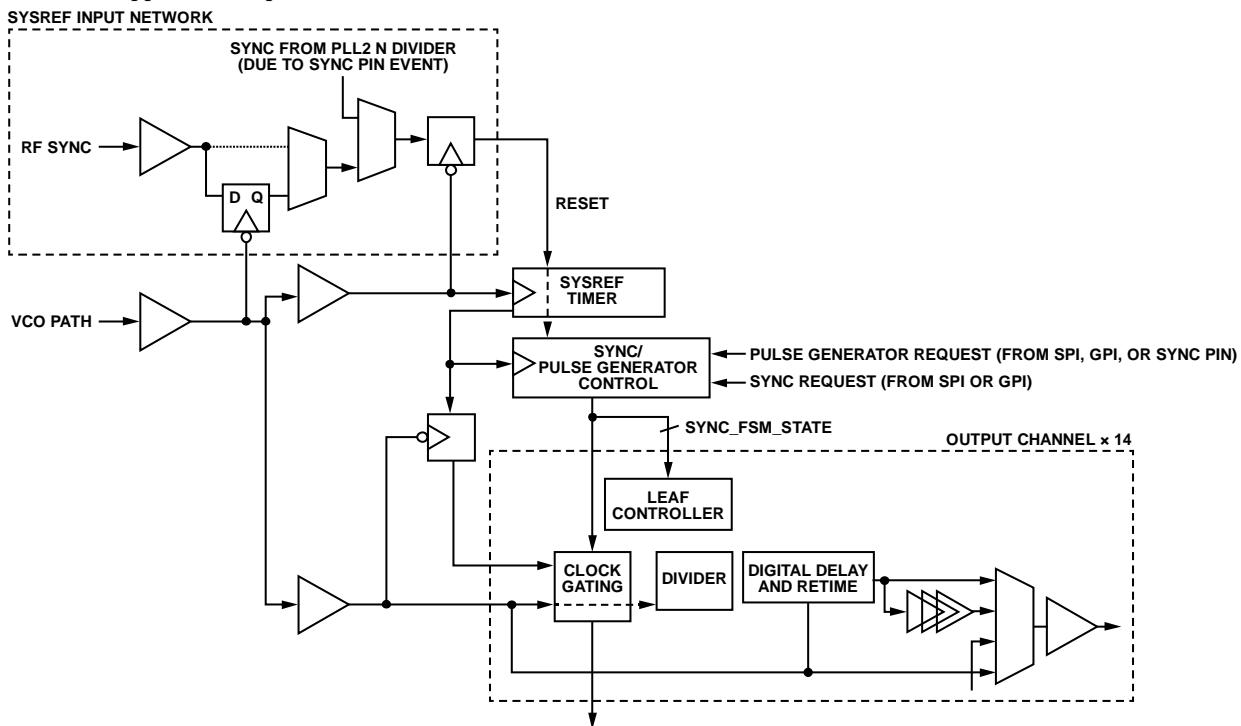

Figure 44. Clock Output Network Simplified Diagram

13035-009



### Basic Output Divider Channel

Each of the 14 output channels are logically identical, and support divide ratios from 1 to 4094. The supported odd divide ratios (1, 3, 5) have 50.0% duty cycle. The only distinction between a SYSREF channel and a DCLK channel is in the SPI configuration and the typical usage of a given channel.

For basic functionality and phase control, each output path consists of the following:

- Divider—generates the logic signal of the appropriate frequency and phase
- Digital phase adjust—adjusts the phase of each channel in increments of  $\frac{1}{2}$  VCO cycles
- Retimer—a low noise flip flop to retime the channel, removing any accumulated jitter
- Analog fine delay—provides a number of ~25 ps delay steps
- Selection mux—selects the fundamental, divider, or analog delay, or an alternate path
- Multimode output buffer—low noise LVDS, CML, CMOS, or LVPECL

The digital phase adjuster and retimer launch on either clock phase of the VCO, depending on the digital phase adjust setpoint (Coarse Digital Delay[4:0]).

To support divider synchronization, arbitrary phase slips, and pulse generator modes, the following blocks are included:

- A clock gating stage pauses the clock for synchronization or slip operations
- An output channel leaf ( $\times 14$ ) controller manages slip, synchronization, and pulse generators with information from the SYSREF FSM

Each channel has an array of control signals. Some of the controls are described in Table 15.

System wide broadcast signals can be triggered from the SPI or general-purpose input (GPI) port to issue a SYNC command (to align dividers to the system internal SYSREF timer), issue a pulse generator stream, (temporarily exporting SYSREF signals to receivers), or to cause the dividers to slip a number of VCO cycles to adjust their phases.

Individual dividers can be made sensitive to these events by adjusting their slip enable, SYNC enable, and Start-Up Mode[1:0] configuration, as described in Table 16.

When output buffers are configured in CMOS mode and phase alignment is required among the outputs, additional multislip delays must be issued for Channel 0, Channel 3, Channel 5, Channel 6, Channel 9, Channel 10, and Channel 13. The value of the delay must be as large as half of the selected divider ratio. Note that this requirement of having additional multislip delays is not needed when channels are used in LVPECL, CML or LVDS mode.

If a channel is configured to behave as a pulse generator, to temporarily power up and power down according to GPI, SPI, or SYNC pin pulse generator commands, it has additional controls to define its behavior outside of the pulse generator chain (see Table 17).

Each divider has an additional phase offset register that adjusts its start phase, or to influence the behavior of slip events sent via the SPI (see Table 18).

Table 19 outlines the typical configuration combinations for a DCLK channel relative to a SYSREF synchronization channel. Note that other combinations are possible. Synchronization of downstream devices can be managed manually, or by using the pulse generator functionality of the [HMC7044](#). See the Typical Programming Sequence section for more information about the differences between the two methods.

Table 15. Basic Divider Controls

Bit Name	Description
Channel Enable	Channel enable. If 0, the channel is disabled. If 1, the channel can be enabled depending on the settings of Start-Up Mode[1:0], Seven Pairs of 14-Channel Outputs Enable[6:0], and sleep mode.
12-Bit Channel Divider[11:0]	Divide ratio. 12-bit divide ratio, split across two words (MSB and LSB). Set to 0 if not using the channel divider (Output Mux Selection[1:0] = 2 or 3).
High Performance Mode	High performance mode. Adjusts divider and buffer bias to slightly improve swing/phase noise at the expense of power. The performance advantage is about 1 dB, and the current penalty depends on whether the divider is enabled.
Coarse Digital Delay[4:0]	Digital delay. Adjusts the phase of the divider signal by up to 17 ½ cycles of the VCO. This circuit is practically noiseless; however, note that a low amount of additional current is consumed.
Fine Analog Delay[4:0]	Analog delay. Adjusts the delay of the divider signal in increments of ~25 ps. Set Output Mux Selection[1:0] = 1 to expose this channel. Causes phase noise degradation of up to 12 dB; therefore, do not use on noise sensitive DCLK channels.
Output Mux Selection[1:0]	Output mux selection. 00 = divider channel, 01 = analog delay, 10 = other channel of pair, 11 = input VCO clock. Fundamental mode can be generated with the divider (12-Bit Channel Divider[11:0] = 1), or via Output Mux Selection[1:0] = 10 and 12-Bit Channel Divider[11:0] = 0. Because the divider path consumes power and degrades phase noise slightly, the fundamental mux path is recommended, but at a cost of a deterministic skew vs. a path that is divider based. Such skew can be compensated for with delay (digital and analog) on the divider-based path.

Table 16. Channel Features

Bit Name	Description
Slip Enable	Slip enable. A channel processes slip requests broadcast from the SPI or GPI (or, if multislip enable = 1, initiated following a recognized SYNC or pulse generator startup).
SYNC Enable	SYNC enable. A channel processes synchronization events broadcast from the SPI or GPI or due to SYNC/RF SYNC (via the SYSREF FSM) to reset its phase. This signal can be safely toggled on and off to adjust SYNC sensitivity without risking the state of the divider.
Start-Up Mode[1:0]	00 = asynchronous (normal mode). The divider starts with uncontrolled phase. It is rephased by SYNC events if SYNC enable = 1. 11 = dynamic (pulse generator mode). The divider monitors pulse generator events broadcast from the SYSREF controller. It is powered up just before a pulse generator chain, rephased at the start, and powered down after the pulse generator chain. This is only supported for divide ratios > 31.

Table 17. Pulse Generator Mode Behavior Options

Bit Name	Description
Dynamic Driver Enable	Dynamic output buffer enable (pulse generator mode only). 0 = the output buffer is simply enabled/disabled with the main channel enable. 1 = the output buffer enable is controlled together with the channel divider, which allows it to dynamically power down outside pulse generator events.
Force Mute[1:0]	Force mute for dynamic mode. If 10, and the channel enable is true (channel enable = 1), the signal just before the output buffer is asynchronously forced to Logic 0 when not generating pulses. Otherwise, if 00, outputs are forced to float naturally to $V_{CM}$ . To see the effect of this, the output buffer must be enabled, which is dependent on the dynamic driver enable and Start-Up Mode[1:0] controls. Logic 0 is supported for CML, LVPECL and CMOS driver modes.

**Table 18. Multislip Configuration**

Bit Name	Description
Multislip Enable	Allow multislip. This bit determines whether the 12-Bit Multislip Digital Delay[11:0] parameter is used for multislip operations. Note that a multislip operation is automatically started following a SYNC or pulse generator initiation if multislip enable = 1.
12-Bit Multislip Digital Delay[11:0]	Multislip amount. If multislip enable = 1, any slip events (caused by GPI, SPI, SYNC, or pulse generator events) repeat the number of times set by 12-Bit Multislip Digital Delay[11:0] to adjust the phase by the multislip amount × VCO cycles. A value of 0 is not supported if multislip enable = 1. Note that phase slips are free from a noise and current perspective, that is, no additional power is needed and with no noise degradation, but they take some time to occur. Each slip operation takes a number of nanoseconds to complete, and thus the phases do not necessarily stabilize immediately. An alarm is available for the user to indicate when all phase operations are complete.

**Table 19. Typical Configuration Combinations**

Bit Name	DCLK	Pulse Generator SYSREF	Manual SYSREF	NonJESD204B
12-Bit Channel Divider[11:0]	Small	Big	Big	Any
Start-Up Mode Bit	Normal	Pulse generator	Normal	Normal
Fine Analog Delay[4:0]	Off	Optional	Optional	Off
Coarse Digital Delay[4:0]	Optional	Optional	Optional	Optional
Slip Enable	Optional	Optional	Optional	Optional
Multislip Enable	Optional	Off	Optional	Optional
High Performance Mode	Optional	Off	Off	Optional
Sync Enable	On	On	On	Optional
Dynamic Driver Enable	Don't care	On	Don't care	Don't care
Force Mute[1:0]	Don't care	On	Don't care	Don't care

**Synchronization FSM/Pulse Generator Timing**

The block diagram showing the interface of the SYNC/pulse generator control to the divider channels and the internal SYSREF timer is shown in Figure 44.

The SYSREF timer counts in periods defined by SYSREF Timer[11:0], a 12-bit setting from the SPI. It sequences the enable, reset, and startup, and disables the downstream dividers in the event of SYNC or pulse generator requests. Program the SYSREF timer count to a submultiple of the lowest output frequency in the clock network, and not faster than 4 MHz. To synchronize divider channels, it is recommended, though not required, that the SYSREF Timer[11:0] bits be set to a related frequency that is either a factor or multiple of other frequencies on the IC.

The pulse generator is defined with respect to the periods of this SYSREF timer, not with respect to the output period. This leads to timing constraint that must be considered to prevent any runt pulses from affecting the pulse generator stream.

Figure 46 shows the start-up behavior of an example divider that is configured as a pulse generator, with a period matching the internal SYSREF period.

The startup of the pulse stream occurs a fixed number of VCO cycles after the FSM transitions to the start phase. Disabling the pulse generator stream where the logic path is forced to zero comes from a combinational path, directly from the FSM.

Because the divider has the option for nearly arbitrary phase adjustment, it provides the opportunity for the stop condition to arrive when the pulse stream is a Logic 1, and creates a runt pulse.

For phase offsets of zero to 50% – 8 VCO cycles, and VCO frequencies <3 GHz, this condition is met naturally within the design. For fanout only mode >3 GHz, it is recommended to use digital delay or slip offsets to increase the natural phase offset and avoid the stress condition.

The situation is avoided by never applying phase offset more than 50% – 8 VCO cycles to an output channel configured as a pulse generator.

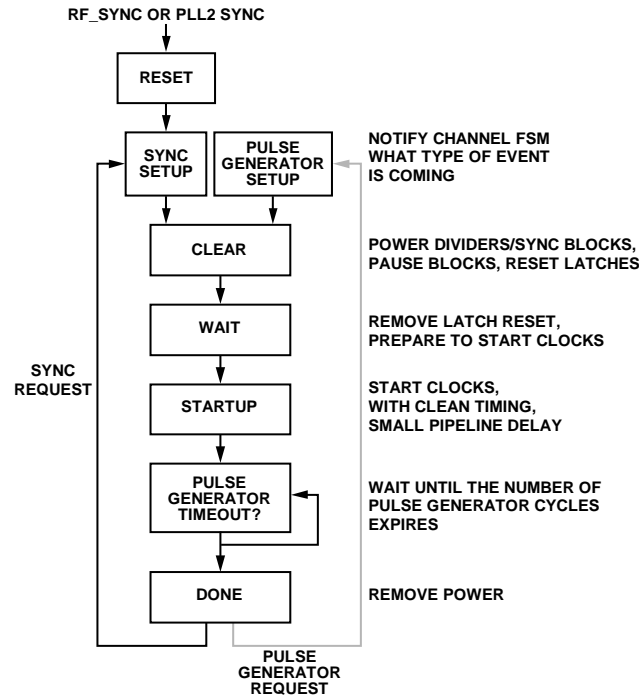

Figure 45. Synchronization FSM Flowchart

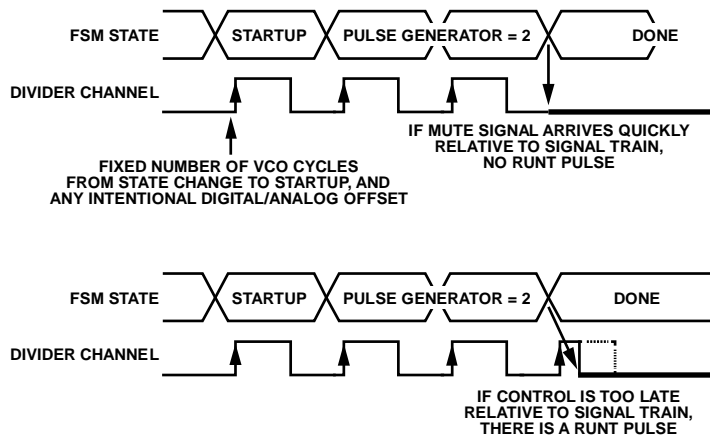

Figure 46. Start-Up Behavior of an Example Divider Configured as a Pulse Generator

**Clock Grouping, Skew, and Crosstalk**

Although the output channels are logically independent, for physical reasons, they are first grouped into pairs called clock groups. Each clock group shares a reference, an input buffer, and a sync retiming flip flop originating from the VCO distribution network.

The second level of grouping is according to the supply pin. Clock Group 1 (Channel 2 and Channel 3) are on an independent supply, and the other supply pins are each responsible for two clock groups.

As the output channels are more tightly coupled (by sharing a clock group, or by sharing a supply pin), the skew is minimized. However, the isolation between those channels suffers. Table 20 shows the clock grouping, and Table 21 show the typical skew and isolation that can be expected and how it scales with distance between output channels.

Isolation improves as either the aggressor or affected frequencies decreases. Nevertheless, for particularly important clock channels where spurious tones must be minimized, carefully consider their frequency and channel configurations to isolate continuously running frequencies onto different supply domains. Channels configured as pulse generators are normally not an issue, because they are disabled during normal operation.

**Table 20. Supply Pin Clock Grouping by Location**

Supply Pin	Location	Clock Group	Channel
VCC2_OUT	Southwest	1	2
			3
VCC4_OUT	South	2	4
			5
		3	6
VCC8_OUT	North	4	8
			9
		5	10
VCC9_OUT	Northwest	6	12
			13
		0	0
			1

**Table 21. Typical Skew and Isolation vs. Distance**

Distance	Typical Skew (ps)	1 GHz Isolation Differential (dB)
Distant Supply Group	±20	90 to 100
Closest Neighbor on Different Supply Group	±15	70
Shared Supply	±10	60
Same Clock Group	±10	45

**Output Buffer Details**

Figure 47 shows the clock groups by supply pin location on the package. With appropriate supply pin bypassing, spurious noise of the outputs is improved. Table 20 describes how the supply pins of each of the 14 clock channels are connected within the seven clock groups. Clock channels that are closest to each other have the best channel to channel skew performance, but they also have the lowest isolation from each other. Select critical signals that require high isolation from each other from groups with distant supply pin locations. An example of the expected isolation and channel to channel skew performance of the HMC7044 at 1 GHz is provided in Table 21.

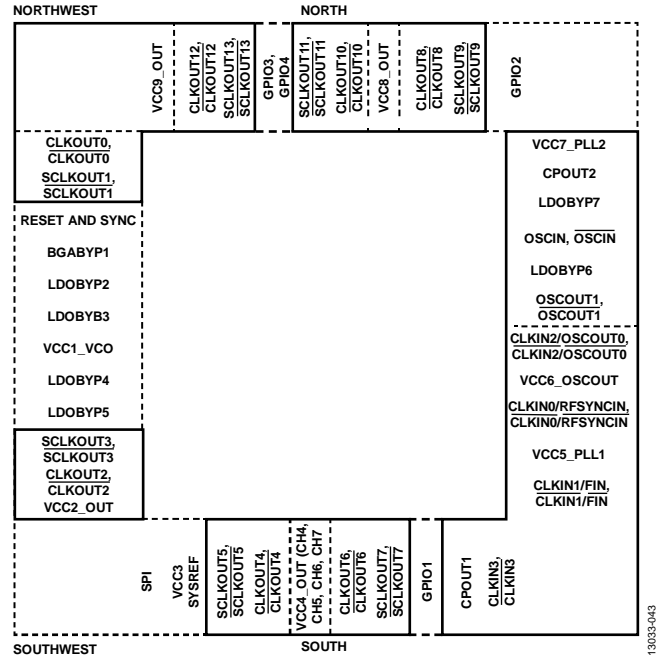

Figure 47. Clock Grouping

**SYSREF Valid Interrupt**

One of the challenges in a JESD204B system is to control and minimize the latency from the primary system controller IC, typically an ASIC or FPGA, to the data converters. To estimate the correct amount of latency in the system, the designer must know how long it takes for a master clock generator like the HMC7044 to provide the correct output phases at each output channel after receiving the synchronization request. Typically, a period of time is required on the device to implement the change requests on the outputs due to internal state machine cycles, data transfers, and any propagation delays. The SYSREF valid interrupt is a function to notify the user that the correct output settings and phase relationships are established, allowing the user to identify quickly that the desired SYSREF and device clock states are presented at the outputs of the HMC7044.

The user has the flexibility to assign the SYSREF valid interrupt to a GPO pin or to use a software flag, set via Register 0x007D, Bit 2, which the user can poll as necessary. The flag notifies the user when the system is configured and operating in the desired state, or conversely when it is not ready.

## REFERENCE BUFFER DETAILS

### Input Termination Network—Common for All Input Buffers

The four reference input buffers to PLL1, as well as the VCXO input buffer, share similar architecture and control features. The input termination network is configurable to 100  $\Omega$ , 200  $\Omega$ , and 2 k $\Omega$  differentially. It is typically ac-coupled on the board, and uses the on-chip resistive divider to set the internal common-mode voltage,  $V_{CM}$ , to 2.1 V.

By closing the 50  $\Omega$  termination switch (see Figure 48), the network also serves as the termination system for an LVPECL driver. Although the input termination network for the four PLL1 reference buffers and the VCXO input buffer is identical, the buffer behind the network is different.

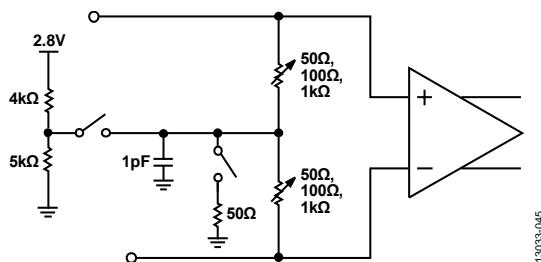

Figure 48. On-Chip Termination Network for VCXO and Reference Buffers

### PLL1 Reference Buffer Stages

The PLL1 reference buffers use a CMOS input stage, are capable of a wide common-mode input range (0.4 V to 2.4 V), and have hysteresis to support reliable LOS detection. These buffers are designed to be driven reliably with an input swing of >375 mV p-p diff (the half swing point of the LVDS standard), and support up to 800 MHz operation. For signal swings that are below 375 mV p-p diff, the hysteresis of the buffer can engage and shut down the signal to the internal reference paths. The exact input hysteresis threshold varies as a function of common-mode level and input frequency, but generally ranges from about 75 mV p-p diff to 300 mV p-p diff.

### VCXO Buffer Stage

The VCXO input buffer is implemented with a bipolar input stage to meet the stringent noise requirements of PLL2. Its common-mode input range is tighter and, if set externally, must be kept between 1.6 V and 2.4 V. This buffer does not have hysteresis and is functional down to very low signal levels. Although the buffer remains functional down to these low signal levels, for optimal performance, keep the input power greater than -4 dBm when driven single-ended, or -7 dBm per side when driven differentially.

### Recommendations for Normal Use

For both styles of buffer, unless there are extenuating circumstances in the application, use the 100  $\Omega$  differential termination to control reflections, use the on-chip dc bias network to set the common-mode level, and externally ac couple the input signals. Do not use receiver side dc termination of the LVPECL signal.

### Single-Ended Operation

The buffers support single-ended signals with a slightly reduced input sensitivity and bandwidth. If driving these buffers single-ended, ac couple the unused section of the buffer to ground at the input of the die.

### Maximum Signal Swing Considerations

The internal supplies to these buffers are regulated from 3.3 V to 2.8 V using on-chip regulation. With very high power references, the signal swing can be enough to drive the signal above the 2.8 V rail. The ESD network and parasitic diodes are generally able to shunt the excess power, and protect the internal circuits even above 13 dBm. Nevertheless, to protect from latch-up concerns, the signals on reference inputs must not exceed the 2.8 V internal supply. For a 2.1 V common-mode, 50  $\Omega$  single-ended source, this 2.8 V limit allows ~700 mV of amplitude, or 6 dBm of maximum reference power.

### TYPICAL PROGRAMMING SEQUENCE

To initialize the HMC7044 to an operational state, use the following programming procedure:

1. Connect the HMC7044 to the rated power supplies. No specific power supply sequencing is necessary.
2. Release the hardware reset by switching from Logic 1 to Logic 0 when all supplies are stable.
3. Load the configuration updates (provided by Analog Devices) to specific registers (see Table 74).
4. Program PLL2. Select the VCO range (high or low). Then program the dividers (R2, N2, and reference doubler).
5. Program PLL1. Set the lock detect timer threshold based on the PLL1 BW of the user system. Set the LCM, R1, and N1 divider setpoints. Enable the reference and VCXO input buffer terminations.
6. Program the SYSREF timer. Set the divide ratio (a submultiple of the lower output channel frequency). Set the pulse generator mode configuration, for example, selecting level sensitive option and the number of pulses desired.
7. Program the output channels. Set the output buffer modes (for example, LVPECL, CML, and LVDS). Set the divide ratio, channel start-up mode, coarse/analog delays, and performance modes.
8. Wait until the VCO peak detector loop has stabilized (~10 ms after Step 4).
9. Ensure that the references are provided to PLL1 and the VCXO is powered.
10. Issue a software restart to reset the system and initiate calibration. Toggle the restart dividers/FSMs bit to 1 and then back to 0.
11. PLL1 starts to lock in parallel with PLL2 going through its calibration and lock procedure. Wait for PLL2 to be locked (takes ~50  $\mu$ s in typical configurations).
12. Confirm that PLL2 is locked by checking the PLL2 lock detect bit.

13. Send a sync request via the SPI (set the reseed request bit) to align the divider phases and send any initial pulse generator stream.
14. Wait 6 SYSREF periods ( $6 \times \text{SYSREF Timer}[11:0]$ ) to allow the outputs to phase appropriately (takes  $\sim 3 \mu\text{s}$  in typical configurations).
15. Confirm that the outputs have all reached their phases by checking that the clock outputs phases status bit = 1.
16. At this time, initialize any other devices in the system. PLL1 may not be locked yet, but the small frequency offset that can result on the output of the HMC7044 is not normally severe enough to cause synchronization or initialization failures. Configure slave JESD204B devices in the system to operate with the SYSREF signal outputs from the HMC7044. SYSREF channels from the HMC7044 can either be on asynchronously, or dynamically, and can temporarily turn on for a pulse generator stream.
17. Wait for PLL1 to lock. This takes  $\sim 50 \text{ ms}$  for a 100 Hz BW (from Step 11).
18. When all JESD204B slaves are powered and ready, send a pulse generator request to send out a pulse generator chain on any SYSREF channels programmed for pulse generator mode.

The system is now initialized.

For power savings and the reduction of the crosscoupling of frequencies on the HMC7044, shut down the SYSREF channels.

1. Program each JESD204B slave to ignore the SYSREF input channel.
2. On the HMC7044, disable the individual channel enable bits of each SYSREF channel.

To resynchronize one or more of the JESD204B slaves, use the following procedure:

1. Set the channel enable (and SYNC enable bit) of the SYSREF channel of interest.
2. To prevent an output channel from responding to a sync request, disable the SYNC enable mask of each channel so that it continues to run normally without a phase adjustment.
3. Issue a reseed request to phase the SYSREF channel properly with respect to the DCLK.
4. Enable the JESD204B slave sensitivity to the SYSREF channel.
5. If the SYSREF channel is in pulse generator mode, wait at least 20 SYSREF periods from Step 3, and issue a pulse generator request.

## POWER SUPPLY CONSIDERATIONS

The HMC7044 contains on-board regulators to shield some of the more sensitive supplies from external noise and interference as much as possible. Nevertheless, the user must still take special care to the supply noise profile of the VCC1\_VCO supply to achieve the intended performance of the device.

In general, a flat input noise of 200 nV/Hz is an equivalent contributor to the VCO noise and causes a 3 dB increase in the noise profile from about 100 kHz to 10 MHz when the VCO is the dominant contributor. This increase equates to a roughly one-to-one conversion from dBV to dBc/Hz at a 1 MHz offset, and  $f_{\text{OUT}} = 2.457 \text{ GHz}$ , that is,  $200 \text{ nV/Hz} = -134 \text{ dBV}$ , and the performance of the VCO at 1 MHz offset at 2.4576 GHz is  $\sim -134 \text{ dBc/Hz}$ . The PSRR of the VCO follows its closed-loop noise profile; therefore, as the offset moves in and the VCO profile becomes higher, the 200 nV/Hz noise stays approximately equal to the VCO. To stay suitably below the VCO, a supply input with  $< 50 \text{ nV/Hz}$  is recommended on the VCC1\_VCO pin across the 100 kHz to 10 MHz frequency range.

The output buffers are also susceptible to supply noise, but to a lesser extent. A noise tone of  $-60 \text{ dBV}$  at a 40 MHz offset results in a  $-90 \text{ dBc}$  tone at the output of the buffers in CML mode and  $-85 \text{ dBc}$  in LVPECL mode. This result is a relatively flat frequency response, and these numbers are measured differentially. Phase noise/spurs caused by supply noise on the output buffers do not scale with output frequency, whereas those on the VCO do.

Table 22 lists the supply network of the HMC7044 by pin, showing the relevant functional blocks. Six different usage profiles are defined for the network, not including the output channel supplies, which are accounted for separately.

The values listed under Profile 0 to Profile 5 in Table 22 and Table 23 are the typical currents of that block or feature. If a number is not listed in a profile column, a typical profile does not exist for that block or feature, but the user can mix and match features outside of the profile list, and can determine what the power consumption is going to be given the current listings per feature.

Table 22. Supply Network of the HMC7044 by Pin for PLL1, PLL2, VCO, and SYSREF

Circuit Block	Comment	Typical Current (mA)	Profile <sup>1</sup>					
			0	1	2	3	4	5
VCC5_PLL1								
CLKIN1/ $\overline{\text{CLKIN1}}$	Used as a PLL1 reference	2		2	2		2	2
CLKIN1/ $\overline{\text{CLKIN1}}$ Buffer	Extra if used as buffer for external VCO	5					5	5
CLKIN0/ $\overline{\text{CLKIN0}}$	Used as a PLL1 reference	2		2				
CLKIN0/ $\overline{\text{CLKIN0}}$ Buffer	Extra current if used as RF synchronization buffer <sup>2</sup>	5						
External VCO Path ( $f_{out}$ )		18					18	
External VCO Path	Extra current for divide by 2	10						
External RF Synchronization Path <sup>3</sup>		3						
Regulator to 1.8V, Bypassed on LDOBYP2	N2, digital functions	2	2	2	2	2	2	2
PLL1 Functions	LOS, R1, N1, FSMs	10		10	10			
PLL2 Functions	R2, N2, lock detect	17		17		17	17	
SYSREF Timer		1		1				
GPO Drivers in High Speed Mode <sup>4</sup>								
Regulator to 2.8V, Bypassed on LDOBYP3		2	2	2	2	2	2	2
PLL1 PFD/CP		7		7	7			
PLL1 DAC Holdover Circuits		2		2				
CLKIN2/ $\overline{\text{CLKIN2}}$ Buffer		2		2				
CLKIN3/ $\overline{\text{CLKIN3}}$ Buffer		2		2				
Subtotal for VCC5_PLL1		90	4	49	23	21	46	11
VCC7_PLL2								
Regulator to 2.8V, Bypassed on LDOBYP7		2	2	2	2	2	2	2
PLL2 PFD, Doubler, and R2 and N2 Outputs		21	4	21		21	21	
PLL2 Charge Pump		8		8		8	8	
Regulator to 2.8V, Bypassed on LDOBYP6		2	2	2	2	2	2	2
VCXO Buffer		16		16	16	16	16	
OSCOUTx/ $\overline{\text{OSCOUTx}}$ Divider/Mux <sup>5</sup>		8						
Subtotal for VCC7_PLL2		57	8	49	20	49	49	4
VCC1_VCO								
VCO Distribution Network	Minimum possible value	71	8	71	0	71	71	71
Sync Retiming Network	Minimum possible value <sup>6</sup>	8						
VCO Regulator, Bypass to LDOBYP4 and LDOBYP5		84		84		84		
VCO Core								
Subtotal for VCC1_VCO		163	8	155	0	155	71	71
VCC3_SYSREF								
SYSREF Input Network <sup>3</sup>		11						
SYSREF Counter Base		12		12				12
SYSREF Counter, SYNC network		4						
Subtotal for VCC3_SYSREF		27	0	12	0	0	0	12
Subtotal (Without Output Paths)			20	265	43	225	166	98

<sup>1</sup> Profile 0 = sleep mode; Profile 1 = power-up defaults, PLL1 with four references and PLL2 locked with internal VCO, SYSREF timer running; Profile 2 = PLL1 only, one reference; Profile 3 = PLL2 + VCO, PLL1 disabled, Profile 4 = PLL2 with external VCO, PLL1 disabled, Profile 5 = fanout mode only, SYSREF running.

<sup>2</sup> This is the incremental amount of current for the circuit when put in this mode. For example, the CLKIN0/ $\overline{\text{CLKIN0}}$  buffer used for PLL1 reference path is 2 mA. If it is used as the external synchronization buffer instead, it is 2 + 5 mA.

<sup>3</sup> The transient current in PLL2 synchronization mode can be temporarily enabled when using external synchronization.

<sup>4</sup> The current is highly dependent on rate of input/output and load of input/output traces. For heavily loaded traces, it is recommended to use a series resistance of ~100  $\Omega$  to minimize the IR drop on the internal regulator during transitions.

<sup>5</sup> The function varies from 8 mA to 14 mA depending on divide ratio.

<sup>6</sup> A temporary current only.



Table 23. Supply Network of the HMC7044 by Pin for the Clock Output Network

Per Output Channel	Comment	Typical Current (mA)	Profile <sup>1</sup>				
			0	1	2	3	4
Digital Regulator and Other Sources		2.5	0.5	2.5	2.5	2.5	2.5
Buffer							
LVPECL	Including term currents	43		43	43		43
CML100							
High Power	Including term currents	31					
Low Power		24					
LVDS							
High Power	At 307 MHz	10				10	
Low Power							
CMOS	At 100 MHz, both sections	25					
Channel Mux		Included <sup>2</sup>					
Digital Delay							
Off		Included <sup>2</sup>					
Setpoint > 1		3			3		3
Analog Delay							
Off		Included <sup>2</sup>		0			
Minimum Setting	Glitchless mode enabled	9			9		
Maximum Setting		9					9
Divider Logic							
0	Not using divider path	Included <sup>2</sup>		0		0	
÷1		27					
÷2		27					
÷3		31					
÷4		29					
÷5		32					
÷6		29					
÷8		30					
÷16		31			31		
÷32		32					
÷2044		32					32
SYNC Logic <sup>3</sup>		4					
Slip Logic <sup>3</sup>		4					
Subtotal			2.5	48	89	13	92

<sup>1</sup> Profile 0 = sleep mode; Profile 1 = fundamental mode; Profile 2 = SYSREF channel matched to fundamental mode; Profile 3 = LVDS—high power signal source from other channel; Profile 4 = worst case configuration for power consumption of a channel.

<sup>2</sup> The base current consumption of the circuit (for example, mux) is included in the buffer typical current.

<sup>3</sup> Currents occur only temporarily during a synchronization event.

# SERIAL CONTROL PORT

## SERIAL PORT INTERFACE (SPI) CONTROL

The HMC7044 can be controlled via the SPI using 24-bit registers and three pins: serial port enable (SLEN) serial data input/output (SDATA), and serial clock (SCLK).

The 24-bit register, shown in Table 24, consists of the following:

- 1-bit read/write command
- 2-bit multibyte field (W1, W0)
- 13-bit address field (A12 to A0)
- 8-bit data field (D7 to D0)

Table 24. SPI Bit Map

MSB			LSB	
Bit 23	Bit 22	Bit 21	Bits[20:8]	Bits[7:0]
R/W	W1	W0	A12 to A0	D7 to D0

### Typical Read Cycle

A typical read cycle is shown in Figure 48 and occurs as follows:

1. The master (host) asserts both SLEN and SDATA to indicate a read, followed by a rising edge SCLK. The slave (HMC7044) reads SDATA on the first rising edge of SCLK after SLEN. Setting SDATA high initiates a read.
2. The host places the 2-bit multibyte field to be written to low (0) on the next two falling edges of SCLK. The HMC7044 registers the 2-bit multibyte field on the next two rising edges of SCLK.
3. The host places the 13-bit address field (A12 to A0) MSB first on SDATA on the next 13 falling edges of SCLK. The HMC7044 registers the 13-bit address field (MSB first) on SDATA over the next 13 rising edges of SCLK.

4. The host registers the 8-bit data on the next eight rising edges of SCLK. The HMC7044 places 8-bit data (D7 to D0) MSB first on the next eight falling edges of SCLK.
5. Deassertion of SLEN completes the register read cycle.

### Typical Write Cycle

A typical write cycle is shown in Figure 49, and occurs as follows:

1. The master (host) asserts both SLEN and SDATA to indicate a read, followed by a rising edge SCLK. The slave (HMC7044) reads SDIO on the first rising edge of SCLK after SLEN. Setting SDATA low initiates a write.
2. The host places the 2-bit multibyte field to be written to low (0) on the next two falling edges of SCLK. The HMC7044 registers the 2-bit multibyte field on the next two rising edges of SCLK.
3. The host places the 13-bit address field (A12 to A0), MSB first on SDATA on the next 13 falling edges of SCLK. The HMC7044 registers the 13-bit address field (MSB first) on SDIO over the next 13 rising edges of SCLK.
4. The host places the 8-bit data (D7 to D0) MSB first on the next eight falling edges of SCLK. The HMC7044 register the 8-bit data (D7 to D0) MSB first on the next eight rising edges of SCLK.
5. The final rising edge of SCLK performs the internal data transfer into the register file, updating the configuration of the device.
6. Deassertion of SLEN completes the register write cycle.

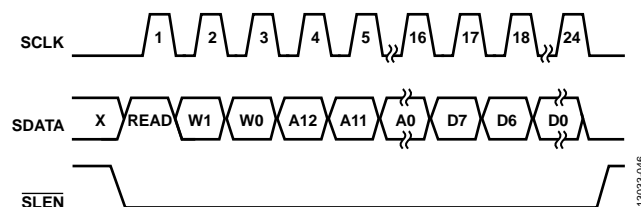

Figure 49. SPI Timing Diagram, Read Operation

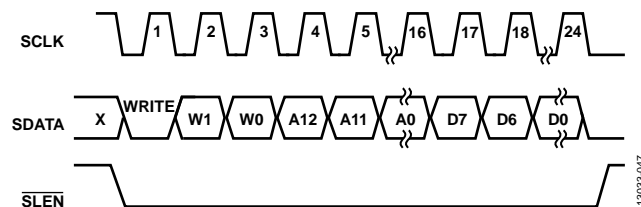

Figure 50. SPI Timing Diagram, Write Operation

## APPLICATIONS INFORMATION

### PLL1 NOISE CALCULATIONS

Use the following equations to calculate the flicker noise, noise floor, and total unfiltered phase noise specifications for PLL1 (see Table 4).

Calculate the flicker noise using the following equation:

$$PN(f_{OUT}, f_{OFFSET}) = \text{Flicker\_FOM} + 20 \times \log(f_{OUT}) - 10 \times \log(f_{OFFSET}) \quad (1)$$

where:

$PN()$  is the phase noise.

$f_{OUT}$  is the output frequency.

$f_{OFFSET}$  is the offset of noise frequency from the output carrier frequency.

$\text{Flicker\_FOM}$  is the figure of merit at the flicker frequency.

Calculate the noise floor as follows:

$$PN(f_{OUT}, f_{PD1}) = \text{Floor\_FOM} + 20 \times \log\left(\frac{f_{OUT}}{f_{PD1}}\right) - 10 \times \log(f_{PD1}) \quad (2)$$

where:

$f_{PD1}$  is the phase detector frequency of PLL1.

$\text{Floor\_FOM}$  is the figure of merit at the floor frequency.

Calculate the total phase noise (unfiltered) as follows:

$$PN(f_{OUT}, f_{PD1}, f_{OFFSET}) = 10 \times \log\left(\sqrt{10^{\left(\frac{PN\_Flicker}{10}\right)^2} + 10^{\left(\frac{PN\_Floor}{10}\right)^2}}\right) \quad (3)$$

where:

$PN\_Flicker$  is the phase noise at the flicker frequency.

$PN\_Floor$  is the phase noise at the floor frequency.

### PLL2 NOISE CALCULATIONS

Use the following equations to calculate the flicker noise, noise floor, and total unfiltered phase noise specifications for PLL2 (see Table 5).

Calculate the flicker noise using the following equation:

$$PN(f_{OUT}, f_{OFFSET}) = \text{Flicker\_FOM} + 20 \times \log(f_{OUT}) - 10 \times \log(f_{OFFSET}) \quad (4)$$

where:

$f_{OUT}$  is the output frequency.

$f_{OFFSET}$  is the offset of noise frequency from the output carrier frequency.

$\text{Flicker\_FOM}$  is the figure of merit at the flicker frequency.

Calculate the noise floor as follows:

$$PN(f_{OUT}, f_{PD2}) = \text{Floor\_FOM} + 20 \times \log\left(\frac{f_{OUT}}{f_{PD2}}\right) - 10 \times \log(f_{PD2}) \quad (5)$$

where:

$\text{Floor\_FOM}$  is the figure of merit at the floor frequency.

$f_{PD2}$  is the phase detector frequency of PLL2.

Calculate the total phase noise (unfiltered) as follows:

$$PN(f_{OUT}, f_{PD2}, f_{OFFSET}) = 10 \times \log\left(\sqrt{10^{\left(\frac{PN\_Flicker}{10}\right)^2} + 10^{\left(\frac{PN\_Floor}{10}\right)^2}}\right) \quad (6)$$

where:

$PN\_Flicker$  is the phase noise at the flicker frequency.

$PN\_Floor$  is the phase noise at the floor frequency.

### PHASE NOISE FLOOR AND JITTER

Use the following equations to calculate the phase noise floor, jitter density, and rms additive jitter due to floor specifications (see Table 9).

Calculate the phase noise floor using the following equation:

$$PN_{FLOOR} = \text{FOM}_{OCHAN} + 10 \times \log(f_{OUT}) + \text{Harmonic Degradation} + \text{Power Degradation} \quad (7)$$

where:

$PN_{FLOOR}$  is the phase noise floor at  $f_{OUT}$ .

$\text{FOM}_{OCHAN}$  is the figure of merit of the output channel.

$\text{Harmonic Degradation}$  is the harmonics of the signal captured in the measurement bandwidth of the receiving instrument/circuit. The noise power of those harmonics can fold and influence the overall noise.

$\text{Power Degradation}$  results when the noise floor ( $-174$  dBm/Hz) of the measurement system approaches the noise power in the phase noise floor of the signal. For example, a phase noise value of  $-155$  dBc/Hz at 0 dBm carrier level is  $-155$  dBm/Hz and is easily measurable. If, however, the carrier level is  $-20$  dBm, the phase noise of  $-155$  dBc/Hz is  $-175$  dBm/Hz, and is not measurable below the other noise sources in the system.

Calculate the jitter density at  $f_{OUT}$  as follows:

$$JITTER\_DENSITY\_FLOOR = 2 \times 10^{\left(\frac{PN_{floor}/10}{f_{OUT} \times 2\pi}\right)} \quad (8)$$

where  $JITTER\_DENSITY\_FLOOR$  is the jitter density of floor at  $f_{OUT}$ .

Calculate the rms additive jitter due to floor using the following equation:

$$JITTER\_RMS\_FLOOR = JITTER\_DENSITY\_FLOOR \times \sqrt{\text{Observation Bandwidth}} \quad (9)$$

where  $\text{Observation Bandwidth}$  is the desired integration bandwidth of the noise with a lower and upper bound offset from the output carrier frequency.

## CONTROL REGISTERS

### CONTROL REGISTER MAP

Register addresses that are not listed in Table 25 are not used, and writing to those registers has no effect. Do not change the values of registers that are marked as reserved. When writing to registers with bits that are marked reserved, take care to always write the default value for the reserved bits, unless listed otherwise in the other controls subsection of Table 25.

**Table 25. Control Register Map**

Addr. (Hex)	Register Name	Bit 7 (MSB)	Bit 6	Bit 5	Bit 4	Bit 3	Bit 2	Bit 1	Bit 0 (LSB)	Default Value (Hex)
Global Control										
0x0000	Global soft reset control	Reserved							Soft reset	0x00
0x0001	Global request and mode control	Reseed request	High performance distribution path	High performance PLLs/VCO	Force holdover	Mute output drivers	Pulse generator request	Restart dividers/FSMs	Sleep mode	0x00
0x0002		Reserved					PLL2 autotune trigger	Slip request	Reserved	0x00
0x0003	Global enable control	Reserved		RF reseeder enable	VCO Selection[1:0]		SYSREF timer enable	PLL2 enable	PLL1 enable	0x37
0x0004		Reserved	Seven Pairs of 14-Channel Outputs Enable[6:0]						0x7F	
0x0005	Global mode and enable control	SYNC Pin Mode Selection[1:0]		CLKIN1/CLKIN1 in external VCO input mode	CLKIN0/CLKIN0 in RF SYNC input mode	PLL1 Reference Path Enable[3:0]			0x4F	
0x0006	Global clear alarms	Reserved							Clear alarms	0x00
0x0007	Global miscellaneous control	Reserved								0x00
0x0008		Reserved (Scratchpad)								0x00
0x0009		Reserved							Disable SYNC at lock	0x01
PLL1										
0x000A	CLKIN0/CLKIN0 input buffer control	Reserved			Input Buffer Mode[3:0]			Buffer enable	0x07	
0x000B	CLKIN1/CLKIN1 input buffer control	Reserved			Input Buffer Mode[3:0]			Buffer enable	0x07	
0x000C	CLKIN2/CLKIN2 input buffer control	Reserved			Input Buffer Mode[3:0]			Buffer enable	0x07	
0x000D	CLKIN3/CLKIN3 input buffer control	Reserved			Input Buffer Mode[3:0]			Buffer enable	0x07	
0x000E	OSCIN/OSCIN input buffer control	Reserved			Input Buffer Mode[3:0]			Buffer enable	0x07	
0x0014	PLL1 reference priority control	Fourth Priority CLKINx/CLKINx Input[1:0]		Third Priority CLKINx/CLKINx Input[1:0]		Second Priority CLKINx/CLKINx Input[1:0]		First Priority CLKINx/CLKINx Input[1:0]		0xE4
0x0015	PLL1 loss of signal (LOS) control	Reserved					LOS Validation Timer[2:0]			0x03
0x0016	PLL1 holdover exit control	Reserved				Holdover Exit Action[1:0]		Holdover Exit Criteria[1:0]		0x0C

Addr. (Hex)	Register Name	Bit 7 (MSB)	Bit 6	Bit 5	Bit 4	Bit 3	Bit 2	Bit 1	Bit 0 (LSB)	Default Value (Hex)
0x0017	PLL1 holdover DAC/ADC control	Reserved	Holdover DAC Value[6:0]							0x00
0x0018		Reserved				ADC tracking disable	Force DAC to holdover in quick mode	Holdover BW Reduction[1:0]		0x04
0x0019	PLL1 LOS mode control	Reserved						LOS bypass input prescaler	LOS uses VCXO prescaler	0x00
0x001A	PLL1 charge pump control	Reserved				PLL1 CP Current[3:0]				0x08
0x001B	PLL1 PFD control	Reserved			PLL1 PFD up enable	PLL1 PFD down enable	PLL1 PFD up force	PLL1 PFD down force	PLL1 PFD polarity	0x18
0x001C	CLKIN0/CLKIN0 input prescaler control	CLKIN0/CLKIN0 Input Prescaler[7:0]								0x04
0x001D	CLKIN1/CLKIN1 input prescaler control	CLKIN1/CLKIN1 Input Prescaler[7:0]								0x01
0x001E	CLKIN2/CLKIN2 input prescaler control	CLKIN2/CLKIN2 Input Prescaler[7:0]								0x04
0x001F	CLKIN3/CLKIN3 input prescaler control	CLKIN3/CLKIN3 Input Prescaler[7:0]								0x01
0x0020	OSCIN/OSCIN Input prescaler control	OSCIN/OSCIN Input Prescaler[7:0]								0x04
0x0021	PLL1 reference divider control (R1)	16-Bit R1 Divider[7:0] (LSB)								0x04
0x0022		16-Bit R1 Divider[15:8] (MSB)								0x00
0x0026	PLL1 feedback divider control (N1)	16-Bit N1 Divider[7:0] (LSB)								0x10
0x0027		16-Bit N1 Divider[15:8] (MSB)								0x00
0x0028	PLL1 lock detect control	Reserved	PLL1 lock detect uses slip	PLL1 Lock Detect Timer[4:0]						0x0F
0x0029	PLL1 reference switching control	Reserved	Bypass debouncer	Manual Mode Reference Switching[1:0]	Holdover uses DAC	Auto-revertive reference switching	Auto-mode reference switching		0x05	
0x002A	PLL1 holdoff time control	Holdoff Timer[7:0]								0x00
PLL2										
0x0031	PLL2 miscellaneous control	Reserved								0x01
0x0032	PLL2 frequency doubler control	Reserved						Bypass frequency doubler		0x01
0x0033	PLL2 reference divider control (R2)	12-Bit R2 Divider[7:0] (LSB)								0x02
0x0034		Reserved				12-Bit R2 Divider[11:8] (MSB)				0x00

Addr. (Hex)	Register Name	Bit 7 (MSB)	Bit 6	Bit 5	Bit 4	Bit 3	Bit 2	Bit 1	Bit 0 (LSB)	Default Value (Hex)
0x0035	PLL2 feedback divider control (N2)	16-Bit N2 Divider[7:0] (LSB)								0x20
0x0036		16-Bit N2 Divider[15:8] (MSB)								0x00
0x0037	PLL2 charge pump control	Reserved				PLL2 CP Current[3:0]				0x0F
0x0038	PLL2 PFD control	Reserved			PLL2 PFD up enable	PLL2 PFD down enable	PLL2 PFD up force	PLL2 PFD down force	PLL2 PFD polarity	0x18
0x0039	OSCOUTx/OSCOUTx path control	Reserved				OSCOUTx/OSCOUTx Divider[1:0]			OSCOUTx/OSCOUTx path enable	0x00
0x003A	OSCOUTx/OSCOUTx driver control	Reserved		OSCOUT0/OSCOUT0 Driver Mode[1:0]		Reserved		OSCOUT0/OSCOUT0 Driver Impedance[1:0]	OSCOUT0/OSCOUT0 driver enable	0x00
0x003B		Reserved		OSCOUT1/OSCOUT1 Driver Mode[1:0]		Reserved		OSCOUT1/OSCOUT1 Driver Impedance[1:0]	OSCOUT1/OSCOUT1 driver enable	0x00
0x003C	PLL2 miscellaneous control	Reserved								0x00
GPIO/SDATA Control										
0x0046	GPI1 control	Reserved			GPI1 Selection[3:0]				GPI1 enable	0x00
0x0047	GPI2 control	Reserved			GPI2 Selection[3:0]				GPI2 enable	0x00
0x0048	GPI3 control	Reserved			GPI3 Selection[3:0]				GPI3 enable	0x09
0x0049	GPI4 control	Reserved			GPI4 Selection[3:0]				GPI4 enable	0x11
0x0050	GPO1 control	GPO1 Selection[5:0]					GPO1 mode	GPO1 enable	0x37	
0x0051	GPO2 control	GPO2 Selection[5:0]					GPO2 mode	GPO2 enable	0x33	
0x0052	GPO3 control	GPO3 Selection[5:0]					GPO3 mode	GPO3 enable	0x00	
0x0053	GPO4 control	GPO4 Selection[5:0]					GPO4 mode	GPO4 enable	0x00	
0x0054	SDATA control	Reserved					SDATA mode	SDATA enable	0x03	
SYSREF/SYNC Control										
0x005A	Pulse generator control	Reserved				Pulse Generator Mode Selection[2:0]				0x00
0x005B	SYNC control	Reserved				SYNC retime	SYNC through PLL2	SYNC polarity	0x06	
0x005C	SYSREF timer control	SYSREF Timer[7:0] (LSB)								0x00
0x005D		Reserved				SYSREF Timer[11:8] (MSB)				0x01
0x005E	SYSREF miscellaneous control	Reserved								0x00

Addr. (Hex)	Register Name	Bit 7 (MSB)	Bit 6	Bit 5	Bit 4	Bit 3	Bit 2	Bit 1	Bit 0 (LSB)	Default Value (Hex)	
Clock Distribution Network											
0x0064	External VCO control	Reserved						Divide by 2 on external VCO enable	Low frequency external VCO path	0x00	
0x0065	Analog delay common control	Reserved							Analog delay low power mode	0x00	
Alarm Masks Registers											
0x0070	PLL1 alarm mask control	PLL1 near lock mask	PLL1 lock acquisition mask	PLL1 lock detect mask	PLL1 holdover status mask	PLL1 CLKINx/CLKINx LOS Mask[3:0]				0x00	
0x0071	Alarm mask control	Reserved			Sync request mask	PLL1 and PLL2 lock detect mask	Clock outputs phase status mask	SYSREF sync status mask	PLL2 lock detect mask	0x10	
Product ID Registers											
0x0078	Product ID	Product ID Value[7:0] (LSB)								0x51	
0x0079		Product ID Value[15:8] (Mid)								0x16	
0x007A		Product ID Value[23:16] (MSB)								0x30	
Alarm Readback Status Registers											
0x007B	Readback register	Reserved							Alarm signal		
0x007C	PLL1 alarm readback	PLL1 near lock	PLL1 lock acquisition	PLL1 lock detect	PLL1 holdover status	CLKINx/CLKINx LOS[3:0]					
0x007D	Alarm readback	Reserved			Sync request status	PLL1 and PLL2 lock detect	Clock outputs phases status	SYSREF sync status	PLL2 lock detect		
0x007E	Latched alarm readback	Reserved	PLL2 lock acquisition latched	PLL1 lock acquisition latched	PLL1 holdover latched	CLKINx/CLKINx LOS Latched[3:0]					
0x007F	Alarm readback miscellaneous	Reserved									
PLL1 Status Registers											
0x0082	PLL1 status registers	Reserved	PLL1 Best Clock[1:0]		PLL1 Active CLKINx/CLKINx[1:0]		PLL1 FSM State[2:0]				
0x0083		Reserved	PLL1 Holdover DAC Averaged Value[6:0]								
0x0084		Holdover comparator value	PLL1 Holdover DAC Current Value[6:0]								
0x0085		Reserved					PLL1 active CLKINx/CLKINx LOS	PLL1 VCXO status	PLL1 holdover ADC status	PLL1 holdover ADC input range status	
0x0086		Reserved				PLL1 Holdover Exit Phase[1:0]		Reserved			
0x0087		Reserved									
PLL2 Status Registers											
0x008C	PLL2 status registers	PLL2 autotune value									
0x008D		PLL2 Autotune Signed Error[7:0] (LSB)									
0x008E		PLL2 autotune status	PLL2 autotune error sign	PLL2 Autotune Signed Error[13:8] (MSB)							
0x008F		PLL2 Autotune FSM State[3:0]					PLL2 SYNC FSM State[3:0]				
0x0090		Reserved									

Addr. (Hex)	Register Name	Bit 7 (MSB)	Bit 6	Bit 5	Bit 4	Bit 3	Bit 2	Bit 1	Bit 0 (LSB)	Default Value (Hex)
SYSREF Status Register										
0x0091	SYSREF status register	Reserved			Channel outputs FSM busy	SYSREF FSM State[3:0]				
Other Controls										
0x0096	Reserved	Reserved			Reserved				0x00	
0x0097	Reserved	Reserved			Reserved				0x00	
0x0098	Reserved	Reserved			Reserved				0x00	
0x0099	Reserved	Reserved			Reserved				0x00	
0x009A	Reserved	Reserved			Reserved				0x00	
0x009B	Reserved	Reserved			Reserved				0xAA	
0x009C	Reserved	Reserved			Reserved				0xAA	
0x009D	Reserved	Reserved			Reserved				0xAA	
0x009E	Reserved	Reserved			Reserved				0xAA	
0x009F	Reserved	Clock output driver low power setting (for optimum performance, set to 0x4D instead of default value)							0x55	
0x00A0	Reserved	Clock output driver high power setting (for optimum performance, set to 0xDF instead of default value)							0x56	
0x00A1	Reserved	Reserved			Reserved				0x97	
0x00A2	Reserved	Reserved			Reserved				0x03	
0x00A3	Reserved	Reserved			Reserved				0x00	
0x00A4	Reserved	Reserved			Reserved				0x00	
0x00A5	Reserved	PLL1 more delay (PFD1, lock detect) (for optimum performance, set to 0x06 instead of default value)							0x00	
0x00A6	Reserved	Reserved			Reserved				0x1C	
0x00A7	Reserved	Reserved			Reserved				0x00	
0x00A8	Reserved	PLL1 holdover DAC $g_m$ setting (for optimum performance, set to 0x06 instead of default value)							0x22	
0x00A9	Reserved	Reserved			Reserved				0x00	
0x00AB	Reserved	Reserved			Reserved				0x00	
0x00AC	Reserved	Reserved			Reserved				0x20	
0x00AD	Reserved	Reserved			Reserved				0x00	
0x00AE	Reserved	Reserved			Reserved				0x08	
0x00AF	Reserved	Reserved			Reserved				0x50	
0x00B0	Reserved	VTUNE preset setting (for optimum performance, set to 0x04 instead of default value)							0x09	
0x00B1	Reserved	Reserved			Reserved				0x0D	
0x00B2	Reserved	Reserved			Reserved				0x00	
0x00B3	Reserved	Reserved			Reserved				0x00	
0x00B5	Reserved	Reserved			Reserved				0x00	
0x00B6	Reserved	Reserved			Reserved				0x00	
0x00B7	Reserved	Reserved			Reserved				0x00	
0x00B8	Reserved	Reserved			Reserved				0x00	
Clock Distribution										
0x00C8	Channel Output 0 control	High performance mode	SYNC enable	Slip enable	Reserved	Start-Up Mode[1:0]	Multislip enable	Channel enable	0xF3	
0x00C9		12-Bit Channel Divider[7:0] (LSB)								0x04
0x00CA		Reserved				12-Bit Channel Divider[11:8] (MSB)				0x00
0x00CB		Reserved				Fine Analog Delay[4:0]				0x00
0x00CC		Reserved				Coarse Digital Delay[4:0]				0x00
0x00CD		12-Bit Multislip Digital Delay[7:0] (LSB)								0x00
0x00CE		Reserved				12-Bit Multislip Digital Delay[11:8] (MSB)				0x00
0x00CF		Reserved						Output Mux Selection[1:0]		0x00
0x00D0		Force Mute[1:0]	Dynamic driver enable	Driver Mode[1:0]		Reserved	Driver Impedance[1:0]		0x01	
0x00D1		Reserved								0x00



Addr. (Hex)	Register Name	Bit 7 (MSB)	Bit 6	Bit 5	Bit 4	Bit 3	Bit 2	Bit 1	Bit 0 (LSB)	Default Value (Hex)	
0x00D2	Channel Output 1 control	High performance mode	SYNC enable	Slip enable	Reserved	Start-Up Mode[1:0]		Multislip enable	Channel enable	0xFD	
0x00D3		12-Bit Channel Divider[7:0] (LSB)								0x00	
0x00D4		Reserved				12-Bit Channel Divider[11:8] (MSB)				0x01	
0x00D5		Reserved				Fine Analog Delay[4:0]				0x00	
0x00D6		Reserved				Coarse Digital Delay[4:0]				0x00	
0x00D7		12-Bit Multislip Digital Delay[7:0] (LSB)								0x00	
0x00D8		Reserved				12-Bit Multislip Digital Delay[11:8] (MSB)				0x00	
0x00D9		Reserved							Output Mux Selection[1:0]		0x00
0x00DA		Force Mute[1:0]		Dynamic driver enable		Driver Mode[1:0]		Reserved	Driver Impedance[1:0]		0x30
0x00DB		Reserved								0x00	
0x00DC	Channel Output 2 control	High performance mode	SYNC enable	Slip enable	Reserved	Start-Up Mode[1:0]		Multislip enable	Channel enable	0xF3	
0x00DD		12-Bit Channel Divider[7:0] (LSB)								0x08	
0x00DE		Reserved				12-Bit Channel Divider[11:8] (MSB)				0x00	
0x00DF		Reserved				Fine Analog Delay[4:0]				0x00	
0x00E0		Reserved				Coarse Digital Delay[4:0]				0x00	
0x00E1		12-Bit Multislip Digital Delay[7:0] (LSB)								0x00	
0x00E2		Reserved				12-Bit Multislip Digital Delay[11:8] (MSB)				0x00	
0x00E3		Reserved							Output Mux Selection[1:0]		0x00
0x00E4		Force Mute[1:0]		Dynamic driver enable		Driver Mode[1:0]		Reserved	Driver Impedance[1:0]		0x01
0x00E5		Reserved								0x00	
0x00E6	Channel Output 3 control	High performance mode	SYNC enable	Slip enable	Reserved	Start-Up Mode[1:0]		Multislip enable	Channel enable	0xFD	
0x00E7		12-Bit Channel Divider[7:0] (LSB)								0x00	
0x00E8		Reserved				12-Bit Channel Divider[11:8] (MSB)				0x01	
0x00E9		Reserved				Fine Analog Delay[4:0]				0x00	
0x00EA		Reserved				Coarse Digital Delay[4:0]				0x00	
0x00EB		12-Bit Multislip Digital Delay[7:0] (LSB)								0x00	
0x00EC		Reserved				12-Bit Multislip Digital Delay[11:8] (MSB)				0x00	
0x00ED		Reserved							Output Mux Selection[1:0]		0x00
0x00EE		Force Mute[1:0]		Dynamic driver enable		Driver Mode[1:0]		Reserved	Driver Impedance[1:0]		0x30
0x00EF		Reserved								0x00	
0x00F0	Channel Output 4 control	High performance mode	SYNC enable	Slip enable	Reserved	Start-Up Mode[1:0]		Multislip enable	Channel enable	0xF3	
0x00F1		12-Bit Channel Divider[7:0] (LSB)								0x02	
0x00F2		Reserved				12-Bit Channel Divider[11:8] (MSB)				0x00	
0x00F3		Reserved				Fine Analog Delay[4:0]				0x00	
0x00F4		Reserved				Coarse Digital Delay[4:0]				0x00	
0x00F5		12-Bit Multislip Digital Delay[7:0] (LSB)								0x00	
0x00F6		Reserved				12-Bit Multislip Digital Delay[11:8] (MSB)				0x00	
0x00F7		Reserved							Output Mux Selection[1:0]		0x00
0x00F8		Force Mute[1:0]		Dynamic driver enable		Driver Mode[1:0]		Reserved	Driver Impedance[1:0]		0x01
0x00F9		Reserved								0x00	

Addr. (Hex)	Register Name	Bit 7 (MSB)	Bit 6	Bit 5	Bit 4	Bit 3	Bit 2	Bit 1	Bit 0 (LSB)	Default Value (Hex)		
0x00FA	Channel Output 5 control	High performance mode	SYNC enable	Slip enable	Reserved	Start-Up Mode[1:0]		Multislip enable	Channel enable	0xFD		
0x00FB		12-Bit Channel Divider[7:0] (LSB)									0x00	
0x00FC		Reserved				12-Bit Channel Divider[11:8] (MSB)						0x01
0x00FD		Reserved				Fine Analog Delay[4:0]						0x00
0x00FE		Reserved				Coarse Digital Delay[4:0]						0x00
0x00FF		12-Bit Multislip Digital Delay[7:0] (LSB)									0x00	
0x0100		Reserved				12-Bit Multislip Digital Delay[11:8] (MSB)						0x00
0x0101		Reserved							Output Mux Selection[1:0]		0x00	
0x0102		Force Mute[1:0]		Dynamic driver enable		Driver Mode[1:0]		Reserved	Driver Impedance[1:0]		0x30	
0x0103		Reserved									0x00	
0x0104	Channel Output 6 control	High performance mode	SYNC enable	Slip enable	Reserved	Start-Up Mode[1:0]		Multislip enable	Channel enable	0xF3		
0x0105		12-Bit Channel Divider[7:0] (LSB)									0x02	
0x0106		Reserved				12-Bit Channel Divider[11:8] (MSB)						0x00
0x0107		Reserved				Fine Analog Delay[4:0]						0x00
0x0108		Reserved				Coarse Digital Delay[4:0]						0x00
0x0109		12-Bit Multislip Digital Delay[7:0] (LSB)									0x00	
0x010A		Reserved				12-bit Multislip Digital Delay[11:8] (MSB)						0x00
0x010B		Reserved							Output Mux Selection[1:0]		0x00	
0x010C		Force Mute[1:0]		Dynamic driver enable		Driver Mode[1:0]		Reserved	Driver Impedance[1:0]		0x01	
0x010D		Reserved									0x00	
0x010E	Channel Output 7 control	High performance mode	SYNC enable	Slip enable	Reserved	Start-Up Mode[1:0]		Multislip enable	Channel enable	0xFD		
0x010F		12-Bit Channel Divider[7:0] (LSB)									0x00	
0x0110		Reserved				12-Bit Channel Divider[11:8] (MSB)						0x01
0x0111		Reserved				Fine Analog Delay[4:0]						0x00
0x0112		Reserved				Coarse Digital Delay[4:0]						0x00
0x0113		12-Bit Multislip Digital Delay[7:0] (LSB)									0x00	
0x0114		Reserved				12-Bit Multislip Digital Delay[11:8] (MSB)						0x00
0x0115		Reserved							Output Mux Selection[1:0]		0x00	
0x0116		Force Mute[1:0]		Dynamic driver enable		Driver Mode[1:0]		Reserved	Driver Impedance[1:0]		0x30	
0x0117		Reserved									0x00	
0x0118	Channel Output 8 control	High performance mode	SYNC enable	Slip enable	Reserved	Start-Up Mode[1:0]		Multislip enable	Channel enable	0xF3		
0x0119		12-Bit Channel Divider[7:0] (LSB)									0x02	
0x011A		Reserved				12-Bit Channel Divider[11:8] (MSB)						0x00
0x011B		Reserved				Fine Analog Delay[4:0]						0x00
0x011C		Reserved				Coarse Digital Delay[4:0]						0x00
0x011D		12-Bit Multislip Digital Delay[7:0] (LSB)									0x00	
0x011E		Reserved				12-Bit Multislip Digital Delay[11:8] (MSB)						0x00
0x011F		Reserved							Output Mux Selection[1:0]		0x00	
0x0120		Force Mute[1:0]		Dynamic driver enable		Driver Mode[1:0]		Reserved	Driver Impedance[1:0]		0x01	
0x0121		Reserved									0x00	

Addr. (Hex)	Register Name	Bit 7 (MSB)	Bit 6	Bit 5	Bit 4	Bit 3	Bit 2	Bit 1	Bit 0 (LSB)	Default Value (Hex)	
0x0122	Channel Output 9 control	High performance mode	SYNC enable	Slip enable	Reserved	Start-Up Mode[1:0]		Multislip enable	Channel enable	0xFD	
0x0123		12-Bit Channel Divider[7:0] (LSB)								0x00	
0x0124		Reserved				12-Bit Channel Divider[11:8] (MSB)				0x01	
0x0125		Reserved				Fine Analog Delay[4:0]				0x00	
0x0126		Reserved				Coarse Digital Delay[4:0]				0x00	
0x0127		12-Bit Multislip Digital Delay[7:0] (LSB)								0x00	
0x0128		Reserved				12-Bit Multislip Digital Delay[11:8] (MSB)				0x00	
0x0129		Reserved							Output Mux Selection[1:0]		0x00
0x012A		Force Mute[1:0]		Dynamic driver enable		Driver Mode[1:0]		Reserved	Driver Impedance[1:0]		0x30
0x012B		Reserved								0x00	
0x012C		Channel Output 10 control	High performance mode	SYNC enable	Slip enable	Reserved	Start-Up Mode[1:0]		Multislip enable	Channel enable	0xF3
0x012D	12-Bit Channel Divider[7:0] (LSB)								0x02		
0x012E	Reserved				12-bit channel divider[11:8] (MSB)				0x00		
0x012F	Reserved				Fine Analog Delay[4:0]				0x00		
0x0130	Reserved				Coarse Digital Delay[4:0]				0x00		
0x0131	12-Bit Multislip Digital Delay[7:0] (LSB)								0x00		
0x0132	Reserved				12-Bit Multislip Digital Delay[11:8] (MSB)				0x00		
0x0133	Reserved							Output mux selection[1:0]		0x00	
0x0134	Force Mute[1:0]		Dynamic driver enable		Driver Mode[1:0]		Reserved	Driver Impedance[1:0]		0x01	
0x0135	Reserved								0x00		
0x0136	Channel Output 11 control		High performance mode	SYNC enable	Slip enable	Reserved	Start-Up Mode[1:0]		Multislip enable	Channel enable	0xFD
0x0137		12-Bit Channel Divider[7:0] (LSB)								0x00	
0x0138		Reserved				12-Bit Channel Divider[11:8] (MSB)				0x01	
0x0139		Reserved				Fine Analog Delay[4:0]				0x00	
0x013A		Reserved				Coarse Digital Delay[4:0]				0x00	
0x013B		12-Bit Multislip Digital Delay[7:0] (LSB)								0x00	
0x013C		Reserved				12-Bit Multislip Digital Delay[11:8] (MSB)				0x00	
0x013D		Reserved							Output Mux Selection[1:0]		0x00
0x013E		Force Mute[1:0]		Dynamic driver enable		Driver Mode[1:0]		Reserved	Driver Impedance[1:0]		0x30
0x013F		Reserved								0x00	
0x0140		Channel Output 12 control	High performance mode	SYNC enable	Slip enable	Reserved	Start-Up Mode[1:0]		Multislip enable	Channel enable	0xF3
0x0141	12-Bit Channel Divider[7:0] (LSB)								0x10		
0x0142	Reserved				12-Bit Channel Divider[11:8] (MSB)				0x00		
0x0143	Reserved				Fine Analog Delay[4:0]				0x00		
0x0144	Reserved				Coarse Digital Delay[4:0]				0x00		
0x0145	12-Bit Multislip Digital Delay[7:0] (LSB)								0x00		
0x0146	Reserved				12-Bit Multislip Digital Delay[11:8] (MSB)				0x00		
0x0147	Reserved							Output Mux Selection[1:0]		0x00	
0x0148	Force Mute[1:0]		Dynamic driver enable		Driver Mode[1:0]		Reserved	Driver Impedance[1:0]		0x01	
0x0149	Reserved								0x00		

Addr. (Hex)	Register Name	Bit 7 (MSB)	Bit 6	Bit 5	Bit 4	Bit 3	Bit 2	Bit 1	Bit 0 (LSB)	Default Value (Hex)		
0x014A	Channel Output 13 control	High performance mode	SYNC enable	Slip enable	Reserved	Start-Up Mode[1:0]		Multislip enable	Channel enable	0xFD		
0x014B		12-Bit Channel Divider[7:0] (LSB)									0x00	
0x014C		Reserved				12-Bit Channel Divider[11:8] (MSB)						0x01
0x014D		Reserved				Fine Analog Delay[4:0]						0x00
0x014E		Reserved				Coarse Digital Delay[4:0]						0x00
0x014F		12-Bit Multislip Digital Delay[7:0] (LSB)									0x00	
0x0150		Reserved				12-Bit Multislip Digital Delay[11:8] (MSB)						0x00
0x0151		Reserved							Output Mux Selection[1:0]		0x00	
0x0152		Force Mute[1:0]		Dynamic driver enable		Driver Mode[1:0]		Reserved	Driver Impedance[1:0]		0x30	
0x0153		Reserved									0x00	

## CONTROL REGISTER MAP BIT DESCRIPTIONS

### Global Control (Register 0x0000 to Register 0x0009)

Table 26. Global Soft Reset Control

Address	Bits	Bit Name	Settings	Description	Access
0x0000	[7:1]	Reserved		Reserved.	RW
	0	Soft reset		Resets all registers, dividers, and FSMs to default values.	

Table 27. Global Request and Mode Control

Address	Bits	Bit Name	Settings	Description	Access
0x0001	7	Reseed request		Requests the centralized resync timer and FSM to reseed any of the output dividers that are programmed to pay attention to sync events. This signal is rising edge sensitive, and is only acknowledged if the resync FSM has completed all events (has finished any previous pulse generator and/or sync events, and is in the done state; SYSREF FSM State[3:0] = 0010).	RW
	6	High performance distribution path	0 1	High performance distribution path select. The VCO clock distribution path has two modes. Power priority. Noise priority. Provides the option for better noise floors on the divided output signals.	
	5	High performance PLLs/VCO	0 1	High performance PLL/VCO select. The VCO has two modes of operation. Power priority. Noise priority. Reduces the phase noise around the carrier.	
	4	Force holdover		Force PLL1 into holdover mode. A holdover request from the GPI or SPI is debounced inside the device when transferred to the PLL1 FSM clock domain (which is nominally at the VCXO or LCM rate). With the debouncer enabled, the delay from force holdover assertion to the HOLDOVER state is six clock cycles. If the debouncer is bypassed, the delay is two clock cycles. To asynchronously tristate the charge pump, the user can disable the up and down signals from the PFD via Bits[4:3] (PLL1 PFD up enable, PLL1 PFD down enable) in the PLL1 PFD control register (Register 0x001B).	
	3	Mute output drivers		Mutes the output drivers (dividers still run in the background).	
	2	Pulse generator request		Asks for a pulse stream (see the Typical Programming Sequence section).	
	1	Restart dividers/FSMs		Resets all dividers and FSMs. Does not affect configuration registers.	
	0	Sleep mode		Forces shutdown. PLL1 and PLL2, output network, and I/O buffers are disabled.	

Address	Bits	Bit Name	Settings	Description	Access
0x0002	[7:3]	Reserved		Reserved.	RW
	2	PLL2 autotune trigger		Triggers an autotune if there is an error/issue when the device comes out of reset.	
	1	Slip request		Requests a slip or multislip event from all divider channels that are sensitive to slip or multislip commands. The dividers are rising edge sensitive and take some time to process the request, after which the phase synchronization alarm is asserted.	
	0	Reserved		Reserved.	

Table 28. Global Enable Control

Address	Bits	Bit Name	Settings	Description	Access
0x0003	[7:6]	Reserved		Reserved	RW
	5	RF reseeder enable		Enable RF reseed for SYSREF	
	[4:3]	VCO Selection[1:0]	00 01 10	Internal disabled/external High Low	
	2	SYSREF timer enable		Enable internal SYSREF time reference	
	1	PLL2 enable		Master analog enable to PLL2	
	0	PLL1 enable		Master analog enable to PLL1	
0x0004	7	Reserved		Reserved	RW
	[6:0]	Seven Pairs of 14 Channel Outputs Enable[6:0]	Bit 0 Bit 1 Bit 2 Bit 3 Bit 4 Bit 5 Bit 6	Enable Channel 0 and Channel 1 Enable Channel 2 and Channel 3 Enable Channel 4 and Channel 5 Enable Channel 6 and Channel 7 Enable Channel 8 and Channel 9 Enable Channel 10 and Channel 11 Enable Channel 12 and Channel 13	

Table 29. Global Mode and Enable Control

Address	Bits	Bit Name	Settings	Description	Access
0x0005	[7:6]	SYNC Pin Mode Selection[1:0]	00	SYNC pin configuration with respect to PLL2. Disabled.	RW
			01	SYNC. A rising edge is carried through PLL2. Useful for multichip synchronization.	
			10	Pulse generator. Request a pulse generator stream from any channels configured for dynamic startup. This behaves in the same way as a GPI requested pulse generator.	
			11	Causes SYNC if alarm exists, otherwise causes pulse generator.	
	5	CLKIN1/CLKIN1 in external VCO input mode		CLKIN1/CLKIN1 input is used for external VCO.	
4	CLKIN0/CLKIN0 in RF SYNC input mode		CLKIN0/CLKIN0 input is used for external RF sync.		
[3:0]	PLL1 Reference Path Enable[3:0]	Bit 0 Bit 1 Bit 2 Bit 3	Selects and enables the reference path for PLL1. Enable CLKIN0/CLKIN0 input path. Enable CLKIN1/CLKIN1 input path. Enable CLKIN2/CLKIN2 input path. Enable CLKIN3/CLKIN3 input path.		

Table 30. Global Clear Alarms

Address	Bits	Bit Name	Settings	Description	Access
0x0006	[7:1]	Reserved		Reserved	RW
	0	Clear alarms		Clear latched alarms	

Table 31. Global Miscellaneous Control

Address	Bits	Bit Name	Settings	Description	Access
0x0007	[7:0]	Reserved		Reserved.	RW
0x0008	[7:0]	Reserved (Scratchpad)		Reserved. The user can write/read to this register to confirm I/Os to the HMC7044. This register does not affect device operation.	RW
0x0009	[7:1]	Reserved		Reserved.	RW
	0	Disable SYNC at lock	0 1	PLL2 sends a sync event up N2 when lock is achieved. This feature is disabled and SYNC is not internally generated on PLL2 lock.	

**PLL1 (Register 0x000A to Register 0x002A)**

Table 32. CLKINx/CLKINx and OSCIN/OSCIN Input Buffer Control

Address	Bits	Bit Name	Settings	Description	Access
0x000A, 0x000B, 0x000C, 0x000D, 0x000E	[7:5]	Reserved		Reserved	RW
	[4:1]	Input Buffer Mode[3:0]	Bit 0 Bit 1 Bit 2 Bit 3	Input buffer control Enable internal 100 Ω termination Enable ac coupling input mode Enable LVPECL input mode Enable high-Z input mode	
	0	Buffer enable		Enable input buffer	

Table 33. PLL1 Reference Priority Control

Address	Bits	Bit Name	Settings	Description	Access
0x0014	[7:6]	Fourth Priority CLKINx/CLKINx Input[1:0]		If third choice clock is not available, use the fourth choice clock	RW
	[5:4]	Third Priority CLKINx/CLKINx Input[1:0]		If second choice clock is not available, use the third choice clock	
	[3:2]	Second Priority CLKINx/CLKINx Input[1:0]		If the first choice clock is not available, use the second choice clock	
	[1:0]	First Priority CLKINx/CLKINx Input[1:0]		This is the first choice clock	

Table 34. PLL1 Loss of Signal (LOS) Control

Address	Bits	Bit Name	Settings	Description	Access
0x0015	[7:3]	Reserved		Reserved.	RW
	[2:0]	LOS Validation Timer[2:0]	000 001 010 011 100 101 110 111	LCM cycles of LOS hysteresis. This is the number of LCM cycles to wait before exiting LOS state when the reference input becomes valid again. <sup>1</sup> None. 2 cycles. 4 cycles. 8 cycles. 16 cycles. 32 cycles. 64 cycles. 128 cycles.	

<sup>1</sup> The LOS revalidation takes between two and three times this number of cycles. The LOS revalidation ambiguity is dependent on whether another channel is in LOS.

Table 35. PLL1 Holdover Exit Control

Address	Bits	Bit Name	Settings	Description	Access
0x0016	[7:4]	Reserved		Reserved	RW
	[3:2]	Holdover Exit Action[1:0]	00 01 10 11	Action the PLL1 FSM takes as it exits holdover mode. Reset dividers. Do nothing. Do nothing. DAC assist.	
	[1:0]	Holdover Exit Criteria[1:0]	X0 <sup>1</sup> 01 11	Criteria the PLL1 FSM uses to exit holdover mode. Exit holdover when LOS is gone. Exit holdover when phase error = 0. Exit holder immediately.	

<sup>1</sup> X means don't care.

Table 36. PLL1 Holdover DAC/ADC Control

Address	Bits	Bit Name	Settings	Description	Access
0x0017	7	Reserved		Reserved	RW
	[6:0]	Holdover DAC Value[6:0]		In holdover mode, if ADC tracking disable is set 1, the holdover DAC control value is set to this value (regarded as an unsigned integer value); otherwise, the holdover average DAC value is summed by this value (regarded as twos complement coded signed integer value)	
0x0018	[7:4]	Reserved		Reserved	RW
	3	ADC tracking disable		Disable ADC tracking; use DAC hold word	
	2	Force DAC to holdover in quick mode		Force DAC control value from DAC current value to computed DAC holdover value immediately, not gradually	
	[1:0]	Holdover BW Reduction[1:0]		Reduce tracking BW	

Table 37. PLL1 LOS Mode Control

Address	Bits	Bit Name	Settings	Description	Access
0x0019	[7:2]	Reserved		Reserved	RW
	1	LOS bypass input prescaler		Bypass LCM R divider cascade; the R1 input is the selected CLKINx/CLKINx input	
	0	LOS uses VCXO prescaler		For very low PFD rates; cascades VCXO LCM divider after N1	

Table 38. PLL1 Charge Pump Control

Address	Bits	Bit Name	Settings	Description	Access
0x001A	[7:4]	Reserved		Reserved	RW
	[3:0]	PLL1 CP Current[3:0]		PLL1 charge pump current	

Table 39. PLL1 PFD Control

Address	Bits	Bit Name	Settings	Description	Access
0x001B	[7:5]	Reserved		Reserved	RW
	4	PLL1 PFD up enable		Enable PLL1 PFD up	
	3	PLL1 PFD down enable		Enable PLL1 PFD down	
	2	PLL1 PFD up force		Force PLL1 charge pump up; do not assert simultaneously with PLL1 PFD down force	
	1	PLL1 PFD down force		Force PLL1 charge pump down; do not assert simultaneously with PLL1 PFD up force	
	0	PLL1 PFD polarity	0 1	Select PFD polarity Positive Negative	

Table 40. CLKIN<sub>x</sub>/CLKIN<sub>x</sub> and OSCIN/OSCIN Input Prescaler Control

Address	Bits	Bit Name	Settings	Description	Access
0x001C	[7:0]	CLKIN0/CLKIN0 Input Prescaler[7:0]		CLKIN0/CLKIN0 Prescaler divider setpoint	RW
0x001D	[7:0]	CLKIN1/CLKIN1 Input Prescaler[7:0]		CLKIN1/CLKIN1 Prescaler divider setpoint	RW
0x001E	[7:0]	CLKIN2/CLKIN2 Input Prescaler[7:0]		CLKIN2/CLKIN2 Prescaler divider setpoint	RW
0x001F	[7:0]	CLKIN3/CLKIN3 Input Prescaler[7:0]		CLKIN3/CLKIN3 Prescaler divider setpoint	RW
0x0020	[7:0]	OSCIN/OSCIN Input Prescaler[7:0]		OSCIN/OSCIN Prescaler divider setpoint	RW

Table 41. PLL1 Reference Divider Control (R1)

Address	Bits	Bit Name	Settings	Description	Access
0x0021	[7:0]	16-Bit R1 Divider[7:0] (LSB)		16-bit R1 divider setpoint LSB	RW
0x0022	[7:0]	16-Bit R1 Divider[15:8] (MSB)		16-bit R1 divider setpoint MSB	RW

Table 42. PLL1 Feedback Divider Control (N1)

Address	Bits	Bit Name	Settings	Description	Access
0x0026	[7:0]	16-Bit N1 Divider[7:0] (LSB)		16-bit N1 divider setpoint LSB	RW
0x0027	[7:0]	16-Bit N1 Divider[15:8] (MSB)		16-bit N1 divider setpoint MSB	RW

Table 43. PLL1 Lock Detect Control

Address	Bits	Bit Name	Settings	Description	Access
0x0028	[7:6]	Reserved		Reserved	RW
	5	PLL1 lock detect uses slip		Use the slip indicator instead of ~2 ns timer for lock detect	
	[4:0]	PLL1 Lock Detect Timer[4:0]		PLL1 lock detect center depth (LCMs); increments of $2^{\text{PLL1 Lock Detect Timer}[4:0]}$ cycles	
			00000	1 cycle	
			00001	2 cycles	
			00010	4 cycles	
		...	...		
		11110	1,073,741,824 cycles		
		11111	2,147,483,648 cycles		



Table 44. PLL1 Reference Switching Control

Address	Bits	Bit Name	Settings	Description	Access
0x0029	[7:6]	Reserved		Reserved	RW
	5	Bypass debouncer		Bypass the debouncer in manual mode and GPI clock/holdover selection	
	[4:3]	Manual Mode Reference Switching[1:0]		If automode REF switching = 0, manual selection of CLKIN <sub>x</sub> /CLKIN <sub>x</sub> input	
	2	Holdover uses DAC	0	In holdover, selects whether PLL1 uses the DAC or tristates the charge pump	
			1	Tristate the charge pump Use holdover DAC	
	1	Autorevertive reference switching		Revert to PLL1 best clock option if it becomes available again	
0	Automode reference switching		Clock switching is automatic based on LOS/PLL1 reference priority control register (Register 0x0014)		

Table 45. PLL1 Holdoff Time Control

Address	Bits	Bit Name	Settings	Description	Access
0x002A	[7:0]	Holdoff Timer[7:0]		PLL1 waits in holdover for 2 <sup>HoldoffTimer[7:0]</sup> LCM cycles to give the abandoned reference a chance to recover before switching to the next priority clock. If Holdoff Timer[7:0] equals to 0, holdoff functionality is disabled and switches directly to the next priority clock.	RW

**PLL2 (Register 0x0031 to Register 0x003C)**

Table 46. PLL2 Miscellaneous Control

Address	Bits	Bit Name	Settings	Description	Access
0x0031	[7:0]	Reserved		Reserved	RW
0x003C	[7:0]	Reserved		Reserved	RW

Table 47. PLL2 Frequency Doubler Control

Address	Bits	Bit Name	Settings	Description	Access
0x0032	[7:1]	Reserved		Reserved	RW
	0	Bypass frequency doubler	0	Bypass PLL2 frequency doubler	
			1	Enable frequency doubler before R2 divider Bypass frequency doubler	

Table 48. PLL2 Reference Divider Control (R2)

Address	Bits	Bit Name	Settings	Description	Access
0x0033	[7:0]	12-Bit R2 Divider[7:0] (LSB)		12-bit R2 divider setpoint LSB. Divide by 1 to divide by 4095. 00000000, 00000001 = divide by 1.	RW
0x0034	[7:4]	Reserved		Reserved.	RW
	[3:0]	12-Bit R2 Divider[11:8] (MSB)		12-Bits R2 divider setpoint MSB.	

Table 49. PLL2 Feedback Divider Control (N2)

Address	Bits	Bit Name	Settings	Description	Access
0x0035	[7:0]	16-Bit N2 Divider[7:0] (LSB)		16-bit N2 divider setpoint LSB.	RW
0x0036	[7:0]	16-Bit N2 Divider[15:8] (MSB)		16-bit N2 divider setpoint MSB.	RW

Table 50. PLL2 Charge Pump Control

Address	Bits	Bit Name	Settings	Description	Access
0x0037	[7:4]	Reserved		Reserved.	RW
	[3:0]	PLL2 CP Current[3:0]		These 4 bits set the magnitude of PLL2 charge pump current. Granularity is ~160 $\mu$ A with full magnitude of ~2560 $\mu$ A.	

Table 51. PLL2 PFD Control

Address	Bits	Bit Name	Settings	Description	Access
0x0038	[7:5]	Reserved		Reserved	RW
	4	PLL2 PFD up enable		Enable PLL2 PFD up	
	3	PLL2 PFD down enable		Enable PLL2 PFD down	
	2	PLL2 PFD up force		Force PLL2 charge pump up; do not assert simultaneously with PLL2 PFD down force	
	1	PLL2 PFD down force		Force PLL2 charge pump down; do not assert simultaneously with PLL2 PFD up force	
	0	PLL2 PFD polarity	0 1	Select PFD polarity Positive Negative	

Table 52. OSCOUTx/OSCOUTx Path Control

Address	Bits	Bit Name	Settings	Description	Access
0x0039	[7:3]	Reserved		Reserved	RW
	[2:1]	OSCOUTx/OSCOUTx Divider[1:0]	00 01 10 11	Oscillator output divider ratio Divided by 1 Divided by 2 Divided by 4 Divided by 8	
	0	OSCOUTx/OSCOUTx path enable		Enable the oscillator output path (divider and the internal path except driver)	

Table 53. OSCOUTx/OSCOUTx Driver Control

Address	Bits	Bit Name	Settings <sup>1</sup>	Description	Access
0x003A, 0x003B	[7:6]	Reserved		Reserved	RW
	[5:4]	OSCOUTx/OSCOUTx Driver Mode[1:0]	00 01 10 11	Oscillator output driver mode selection CML mode LVPECL mode LVDS mode CMOS mode	
	[3]	Reserved		Reserved	
	[2:1]	OSCOUTx/OSCOUTx Driver Impedance[1:0]	00 01 10 11	Oscillator output driver impedance selection for CML mode Internal resistor disable Internal 100 $\Omega$ resistor enable per output pin Reserved Internal 50 $\Omega$ resistor enable per output pin	
	0	OSCOUTx/OSCOUTx driver enable		Enable oscillator driver	

<sup>1</sup> X means don't care.

**GPIO/SDATA Control (Register 0x0046 to Register 0x0054)****Table 54. GPIx Control**

Address	Bits	Bit Name	Settings	Description	Access
0x0046, 0x0047, 0x0048, 0x0049	[7:5]	Reserved		Reserved.	RW
	[4:1]	GPIx Selection[3:0]	0000	Reserved.	
			0001	Force PLL1 to holdover.	
			0010	Select PLL1 reference manually, Bit 1.	
			0011	Select PLL1 reference manually, Bit 0.	
			0100	Put the chip into sleep mode.	
			0101	Issue a mute.	
			0110	Select the internal VCO type manually.	
			0111	Select high performance mode for PLL2 and the internal VCO.	
			1000	Issue a pulse generator request.	
			1001	Issue a reseed request.	
			1010	Issue a restart request.	
			1011	Force the chip into fanout mode.	
			1100	Reserved.	
1101	Issue a slip request				
1110	Reserved.				
1111	Reserved.				
0	GPIx enable		GPIx function enable. Before changing the function of the pin, disable it first, and then reenable it after the function change. <sup>1</sup>		

<sup>1</sup> Note that it is possible to have a GPIOx pin configured as both an output and an input.

**Table 55. GPOx Control**

Address	Bits	Bit Name	Settings	Description	Access
0x0050, 0x0051, 0x0052, 0x0053	[7:2]	GPOx Selection[5:0]	000000	Select the GPOx functionality	RW
			000001	Alarm signal	
			000010	SDATA from SPI communication	
			000011	CLKIN3/ $\overline{\text{CLKIN3}}$ LOS for CLKIN3/ $\overline{\text{CLKIN3}}$ input	
			000100	CLKIN2/ $\overline{\text{CLKIN2}}$ LOS for CLKIN2/ $\overline{\text{CLKIN2}}$ input	
			000101	CLKIN1/ $\overline{\text{CLKIN1}}$ LOS for CLKIN1/ $\overline{\text{CLKIN1}}$ input	
			000110	CLKIN0/ $\overline{\text{CLKIN0}}$ LOS for CLKIN0/ $\overline{\text{CLKIN0}}$ input	
			000111	PLL1 holdover enabled signal from PLL1	
			001000	Lock detect signal from PLL1	
			001001	Acquiring lock signal from PLL1	
			001010	PLL1 near lock acquisition status signal from PLL1	
			001011	PLL2 lock detect signal from PLL2	
			001100	SYSREF sync status has not synchronized since reset	
			001101	Clock outputs phase status	
			001110	PLL1 and PLL2 lock detect is locked	
			001111	Sync request status signal	
			010000	PLL1 active CLKIN0/ $\overline{\text{CLKIN0}}$	
			010001	PLL1 active CLKIN1/ $\overline{\text{CLKIN1}}$	
			010010	PLL1 holdover ADC input range status	
			010011	PLL1 holdover ADC input status	
			010100	PLL1 VCXO status	
			010101	PLL1 active CLKINx/ $\overline{\text{CLKINx}}$ status	
010110	PLL1 FSM state, Bit 0				
010111	PLL1 FSM state, Bit 1				
011011	PLL1 FSM state, Bit 2				

Address	Bits	Bit Name	Settings	Description	Access
			011000	PLL1 holdover exit phase, Bit 0	
			011001	PLL1 holdover exit phase, Bit 1	
			011010	Channel outputs FSM busy	
			011011	SYSREF FSM state, Bit 0	
			011100	SYSREF FSM state, Bit 1	
			011101	SYSREF FSM state, Bit 2	
			011110	SYSREF FSM state, Bit 3	
			011111	Force Logic 1 to GPO	
			100000	Force Logic 0 to GPO	
			100001	Reserved	
			100010	Reserved	
			100011	Reserved	
			100100	Reserved	
			100101	Reserved	
			100110	Reserved	
			100111	PLL1 holdover DAC averaged value, Bit 0	
			101000	PLL1 holdover DAC averaged value, Bit 1	
			101001	PLL1 holdover DAC averaged value, Bit 2	
			101010	PLL1 holdover DAC averaged value, Bit 3	
			101011	PLL1 holdover DAC current value, Bit 0	
			101100	PLL1 holdover DAC current value, Bit 1	
			101101	PLL1 holdover DAC current value, Bit 2	
			101110	PLL1 holdover DAC current value, Bit 3	
			101111	Reserved	
			110000	Reserved	
			110001	Reserved	
			110010	Reserved	
			110011	Reserved	
			110100	Reserved	
			110101	Reserved	
			110110	Reserved	
			110111	Reserved	
			111000	Reserved	
			111001	Reserved	
			111010	Reserved	
			111011	Reserved	
			111100	Reserved	
			111101	Holdover comparator status	
			111110	Pulse generator request status signal	
			111111	Reserved	
	1	GPOx mode	0 1	Selects the mode of GPOx driver Open-drain mode CMOS mode	
	0	GPOx enable		GPOx driver enable	

Table 56. SDATA Control

Address	Bits	Bit Name	Settings	Description	Access
0x0054	[7:2]	Reserved		Reserved	RW
	1	SDATA mode	0 1	Selects the mode of SDATA driver Open-drain mode CMOS mode	
	0	SDATA enable		SDATA driver enable	

**SYSREF/SYNC Control (Register 0x005A to Register 0x005E)****Table 57. Pulse Generator Control**

Address	Bits	Bit Name	Settings	Description	Access
0x005A	[7:3]	Reserved		Reserved.	RW
	[2:0]	Pulse Generator Mode Selection[2:0]		SYSREF output enable with pulse generator.	
			000	Level sensitive. When the GPLx is configured to issue a pulse generator request (GPLx Selection[3:0] = 1000), or a pulse generator request is issued through the SPI or as a SYNC pin-based pulse generator, run the pulse generator. Otherwise, stop the pulse generator.	
			001	1 pulse.	
			010	2 pulses.	
			011	4 pulses.	
			100	8 pulses.	
			101	16 pulses.	
			110	16 pulses.	
111	Continuous mode (50% duty cycle).				

**Table 58. SYNC Control**

Address	Bits	Bit Name	Settings	Description	Access
0x005B	[7:3]	Reserved		Reserved	RW
	2	SYNC retime	0	Bypass the retime (if using SYNC path with on-chip VCO)	
			1	Retime the external SYNC from Reference 0	
	1	SYNC through PLL2		Allow a reseed event to be through PLL2	
0	SYNC polarity	0	Positive		
		1	Negative		

**Table 59. SYSREF Timer Control**

Address	Bits	Bit Name	Settings	Description	Access
0x005C	[7:0]	SYSREF Timer[7:0] (LSB)		12-bit SYSREF timer setpoint LSB. This sets the internal beat frequency of the master timer, which controls synchronization and pulse generator events. Set the 12-bit timer to a submultiple of the lowest output SYSREF frequency, and program it to be no faster than 4 MHz.	RW
0x005D	[7:4]	Reserved		Reserved.	RW
	[3:0]	SYSREF Timer[11:8] (MSB)		12-bit SYSREF timer setpoint MSB.	

**Table 60. SYSREF Miscellaneous Control**

Address	Bits	Bit Name	Settings	Description	Access
0x005E	[7:0]	Reserved		Reserved	RW

**Clock Distribution Network (Register 0x0064 to Register 0x0065)****Table 61. External VCO Control**

Address	Bits	Bit Name	Settings	Description	Access
0x0064	[7:2]	Reserved		Reserved	RW
	1	Divide by 2 on external VCO enable		Use divide by 2 on external VCO path	
	0	Low frequency external VCO path		Changes bias to Class A for low frequency VCO	

Table 62. Analog Delay Common Control

Address	Bits	Bit Name	Settings	Description	Access
0x0065	[7:1]	Reserved		Reserved.	RW
	0	Analog delay low power mode		Analog delay is in low power mode, which can save power for low settings of analog delay, but is not glitchless between setpoints.	

**Alarm Masks Registers (Register 0x0070 to Register 0x0071)**

Table 63. PLL1 Alarm Mask Control

Address	Bits	Bit Name	Settings	Description	Access
0x0070	7	PLL1 near lock mask		If set, allow the PLL1 near lock signal to generate alarm signal	RW
	6	PLL1 lock acquisition mask		If set, allow the PLL1 lock acquisition signal to generate alarm signal	
	5	PLL1 lock detect mask		If set, allow the PLL1 lock detect signal to generate alarm signal	
	4	PLL1 holdover status mask		If set, allow the PLL1 holdover status signal to generate alarm signal	
	[3:0]	PLL1 CLKINx/CLKINx Status Mask[3:0]	Bit 0 Bit 1 Bit 2 Bit 3	If set, allow CLKIN0/CLKIN0 LOS to generate alarm signal If set, allow CLKIN1/CLKIN1 LOS to generate alarm signal If set, allow CLKIN2/CLKIN2 LOS to generate alarm signal If set, allow CLKIN3/CLKIN3 LOS to generate alarm signal	

Table 64. Alarm Mask Control

Address	Bits	Bit Name	Settings	Description	Access
0x0071	[7:5]	Reserved		Reserved	RW
	4	Sync request mask		If set, allow the sync request signals to generate alarm signal	
	3	PLL1 and PLL2 lock detect mask		If set, allow the PLL1 and PLL2 lock detect signals to generate alarm signal	
	2	Clock outputs phases status mask		If set, allow the clock outputs phases status signal to generate alarm signal	
	1	SYSREF sync status mask		If set, allow the SYSREF sync status signal to generate alarm signal	
	0	PLL2 lock detect mask		If set, allow the PLL2 lock detect signal to generate alarm signal	

**Product ID Registers (Register 0x0078 to Register 0x007A)**

Table 65. Product ID

Address	Bits	Bit Name	Settings	Description	Access
0x0078	[7:0]	Product ID Value[7:0] (LSB)		24-bit product ID value low	R
0x0079	[7:0]	Product ID Value[15:8] (Mid)		24-bit product ID value high	R
0x007A	[7:0]	Product ID Value[23:16] (MSB)		24-bit product ID value very high	R

**Alarm Readback Status Registers (Register 0x007B to Register 0x007F)**

Table 66. Readback Register

Address	Bits	Bit Name	Settings	Description	Access
0x007B	[7:1]	Reserved		Reserved.	R
	0	Alarm signal		Readback alarm status from SPI.	

Table 67. PLL1 Alarm Readback

Address	Bits	Bit Name	Settings	Description	Access	
0x007C	7	PLL1 near lock		PLL1 near locked. Declare near locked when the counter reaches 1/16 of the programmable limit.	R	
	6	PLL1 lock acquisition		PLL1 acquiring lock.		
	5	PLL1 lock detect		PLL1 locked.		
	4	PLL1 holdover status		PLL1 in holdover.		
	[3:0]	CLKINx/CLKINx LOS[3:0]	Bit 0			CLKIN0/CLKIN0 LOS.
			Bit 1			CLKIN1/CLKIN1 LOS.
			Bit 2			CLKIN2/CLKIN2 LOS.
			Bit 3			CLKIN3/CLKIN3 LOS.

Table 68. Alarm Readback

Address	Bits	Bit Name	Settings	Description	Access	
0x007D	[7:5]	Reserved		Reserved.	R	
	4	Sync request status		PLL2 locked (or disabled), but unsynchronized.		
	3	PLL1 and PLL2 lock detect				PLL1 and PLL2 lock detect status.
			0			Either PLL1 or PLL2 is not locked or both PLL1 and PLL2 are not locked.
	1	PLL1 and PLL2 are locked.	1			PLL1 and PLL2 are locked.
						SYSREF alarm.
	2	Clock outputs phases status	0			SYSREF of the HMC7044 is not valid; that is, its phase output is not stable.
			1			SYSREF of the HMC7044 is valid and locked; that is, its phase output is stable.
						SYSREF SYNC status alarm.
	1	SYSREF sync status	0			The HMC7044 has been synchronized with an external sync pulse or a sync request from the SPI.
			1			The HMC7044 never synchronized with an external sync pulse or a sync request from the SPI.
	0	PLL2 lock detect	1			PLL2 near locked. Declare near locked when counter reaches 1/16 of the programmable limit.

Table 69. Latched Alarm Readback

Address	Bits	Bit Name	Settings	Description	Access	
0x007E	7	Reserved		Reserved.	R	
	6	PLL2 lock acquisition latched		Readback record of PLL2 lock acquisition since the last clear event.		
	5	PLL1 lock acquisition latched		Readback record of PLL1 lock acquisition since the last clear event.		
	4	PLL1 holdover latched		Readback record of PLL1 holdover since the last clear event.		
	[3:0]	CLKINx/CLKINx Latched[3:0]	Bit 0			Readback record of CLKIN0/CLKIN0 LOS since the last clear event.
			Bit 1			Readback record of CLKIN1/CLKIN1 LOS since the last clear event.
			Bit 2			Readback record of CLKIN2/CLKIN2 LOS since the last clear event.
			Bit 3			Readback record of CLKIN3/CLKIN3 LOS since the last clear event.

Table 70. Alarm Readback Miscellaneous

Address	Bits	Bit Name	Settings	Description	Access
0x007F	[7:0]	Reserved		Reserved.	R

**PLL1 Status Registers (Register 0x0082 to Register 0x0087)****Table 71. PLL1 Status Registers**

Address	Bits	Bit Name	Settings	Description	Access
0x0082	7	Reserved		Reserved	R
	[6:5]	PLL1 Best Clock[1:0]		Indicates which clock the LOS/priority encoder prefers if automode reference switching is used	
	[4:3]	PLL1 Active CLKINx/ CLKINx[1:0]		Indicates which CLKINx/CLKINx input is currently in use	
	[2:0]	PLL1 FSM State[2:0]		Sets the state PLL1 is in	
			000	Reset	
			001	Acquisition	
			010	Locked	
			011	Invalid	
100			Holdover		
		101	DAC assisted holdover exit		
0x0083	7	Reserved		Reserved	R
	[6:0]	Holdover DAC Averaged Value[6:0]		Average DAC code	
0x0084	7	Holdover comparator value		Holdover comparator output value (DAC output vs. PLL1 V <sub>TUNE</sub> )	R
	[6:0]	Holdover DAC Current Value[6:0]		Current DAC code	
0x0085	[7:4]	Reserved		Reserved	R
	3	PLL1 active CLKINx/CLKINx LOS		LOS of the currently active reference	
	2	PLL1 VCXO status		Indicates whether any of the enabled references appears to run faster than the VCXO	
	1	PLL1 holdover ADC status	0	ADC is acquiring	
			1	PLL1 V <sub>TUNE</sub> is moving quickly	
	0	PLL1 holdover ADC input range status	0	PLL1 V <sub>TUNE</sub> is in range	
1			PLL1 V <sub>TUNE</sub> is out of range		
0x0086	[7:5]	Reserved		Reserved	R
	[4:3]	PLL1 Holdover Exit Phase[1:0]		The phase of the PLL1 holdover exit	
	[2:0]	Reserved		Reserved	
0x0087	[7:0]	Reserved		Reserved	R

**PLL2 Status Registers (Register 0x008C to Register 0x0090)****Table 72. PLL2 Status Registers**

Address	Bits	Bit Name	Settings	Description	Access
0x008C	[7:0]	PLL2 autotune value		After autotune, this word is populated with the selected capacitor bank of the VCO	R
0x008D	[7:0]	PLL2 Autotune Signed Error[7:0] (LSB)		14-bit PLL2 V <sub>TUNE</sub> error count, LSB	R
0x008E	7	PLL2 autotune status	1	Autotune busy	R
			0	Done/not working	
	6	PLL2 autotune error sign		Sign of PLL2 autotune error	
			0	Positive	
			1	Negative	
[5:0]	PLL2 Autotune Signed Error[13:8] (MSB)		14-bit PLL2 V <sub>TUNE</sub> error count, MSB		



Address	Bits	Bit Name	Settings	Description	Access
0x008F	[7:4]	PLL2 Autotune FSM State[3:0]		Autotune FSM state	R
			0000	Idle	
			0001	Startup	
			0010	Startup	
			0011	Reset	
			0100	Reset	
			0101	Reset	
			0110	Measure	
			0111	Wait	
			1000	Wait	
			1001	Update loop to state 18 times	
			1010	Round	
	1011	Finish			
	[3:0]	PLL2 SYNC FSM State[3:0]		PLL2 sync carry FSM state	
			0000	Idle	
			0100	Power up Section A of the FSM	
			0110	Power up Section B of the FSM	
			0111	Sending to N2	
			1100	Power down Section B of the FSM	
0x0090	[7:0]	Reserved		Reserved	R

### SYSREF Status Register (Register 0x0091)

Table 73. SYSREF Status Register

Address	Bits	Bit Name	Settings	Description	Access
0x0091	[7:5]	Reserved		Reserved.	R
	4	Channel outputs FSM busy		One of clock outputs FSM requested clock, and it is running.	
	[3:0]	SYSREF FSM State[3:0]		Indicates the current step of the SYSREF reseed process. Note that the three different progressions are caused by different trigger events (reseed, pulse generator, reserved).	
			0000	Reset.	
			0010	Done.	
			0100	Get ready.	
			0101	Get ready.	
			0110	Get ready.	
			1010	Running (pulse generator).	
			1011	Start.	
			1100	Power up.	
			1101	Power up.	
			1110	Power up.	
			1111	Clear reset.	

**Other Controls (Register 0x0096 to Register 0x00B8)**

For optimum performance of the chip, Register 0x0096 to Register 0x00B8 must be programmed to a different value than their default value.

**Table 74. Reserved Registers**

Address	Bits	Bit Name	Settings	Description	Access
0x0096	[7:0]	Reserved		Reserved	RW
0x0097	[7:0]	Reserved		Reserved	RW
0x0098	[7:0]	Reserved		Reserved	RW
0x0099	[7:0]	Reserved		Reserved	RW
0x009A	[7:0]	Reserved		Reserved	RW
0x009B	[7:0]	Reserved		Reserved	RW
0x009B	[7:0]	Reserved		Reserved	RW
0x009C	[7:0]	Reserved		Reserved	RW
0x009D	[7:0]	Reserved		Reserved	RW
0x009E	[7:0]	Reserved		Reserved	RW
0x009F	[7:0]	Reserved		Clock output driver low power setting (set to 0x4D instead of default value)	RW
0x00A0	[7:0]	Reserved		Clock output driver high power setting (set to 0xDF instead of default value)	RW
0x00A1	[7:0]	Reserved		Reserved	RW
0x00A2	[7:0]	Reserved		Reserved	RW
0x00A3	[7:0]	Reserved		Reserved	RW
0x00A4	[7:0]	Reserved		Reserved	RW
0x00A5	[7:0]	Reserved		PLL1 more delay (PFD1, lock detect) (set to 0x06 instead of default value)	RW
0x00A6	[7:0]	Reserved		Reserved	RW
0x00A7	[7:0]	Reserved		Reserved	RW
0x00A8	[7:0]	Reserved		PLL1 holdover DAC $g_m$ setting (set to 0x06 instead of default value)	RW
0x00A9	[7:0]	Reserved		Reserved	RW
0x00AB	[7:0]	Reserved		Reserved	RW
0x00AC	[7:0]	Reserved		Reserved	RW
0x00AD	[7:0]	Reserved		Reserved	RW
0x00AE	[7:0]	Reserved		Reserved	RW
0x00AF	[7:0]	Reserved		Reserved	RW
0x00B0	[7:0]	Reserved		$V_{TUNE}$ preset setting (set to 0x04 instead of default value)	RW
0x00B1	[7:0]	Reserved		Reserved	RW
0x00B2	[7:0]	Reserved		Reserved	RW
0x00B3	[7:0]	Reserved		Reserved	RW
0x00B4	[7:0]	Reserved		Reserved	RW
0x00B5	[7:0]	Reserved		Reserved	RW
0x00B6	[7:0]	Reserved		Reserved	RW
0x00B7	[7:0]	Reserved		Reserved	RW
0x00B8	[7:0]	Reserved		Reserved	RW

**Clock Distribution (Register 0x00C8 to Register 0x0153)**

The bit descriptions in Table 75 apply to all 14 channels.

**Table 75. Channel 0 to Channel 13 Control**

Address	Bits	Bit Name	Settings <sup>1</sup>	Description	Access
0x00C8, 0x00D2, 0x00DC, 0x00E6, 0x00F0, 0x00FA, 0x0104, 0x010E, 0x0118, 0x0122, 0x012C, 0x0136, 0x0140, 0x014A	7	High performance mode		High performance mode. Adjusts the divider and buffer bias to improve swing/phase noise at the expense of power.	RW
	6	SYNC enable		Susceptible to SYNC event. The channel can process a SYNC event to reset its phase.	
	5	Slip enable		Susceptible to slip event. The channel can process a slip request from SPI or GPI. Note that if slip enable is true but multislip is off, a channel slips by 1 VCO cycle on an explicit slip request broadcast from the SPI/GPI.	
	4	Reserved		Reserved.	
	[3:2]	Start-Up Mode[1:0]	00 01 10 11	Configures the channel to normal mode with asynchronous startup, or to a pulse generator mode with dynamic start-up. Note that this must be set to asynchronous mode if the channel is unused. Asynchronous. Reserved. Reserved. Dynamic.	
	1	Multislip enable	0 1	Allow multislip operation (default = 0 for SYSREF, 1 for DCLK). Do not engage automatic multislip on channel startup. Multislip events after SYNC or pulse generator request, if slip enable, Bit = 1.	
0	Channel enable		Channel enable. If this bit is 0, channel is disabled.		
0x00C9, 0x00D3, 0x00DD, 0x00E7, 0x00F1, 0x00FB, 0x0105, 0x010F, 0x0119, 0x0123, 0x012D, 0x0137, 0x0141, 0x014B	[7:0]	12-Bit Channel Divider[7:0] (LSB)		12-bit channel divider setpoint LSB. The divider supports even divide ratios from 2 to 4094. The supported odd divide ratios are 1, 3, and 5. All even and odd divide ratios have 50.0% duty cycle.	RW
	[7:4]	Reserved		Reserved.	RW
0x00CA, 0x00D4, 0x00DE, 0x00E8, 0x00F2, 0x00FC, 0x0106, 0x0110, 0x011A, 0x0124, 0x012E, 0x0138, 0x0142, 0x014C	[3:0]	12-Bit Channel Divider[11:8] (MSB)		12-bit channel divider setpoint MSB.	
	[7:5]	Reserved		Reserved.	RW
0x00CB, 0x00D5, 0x00DF, 0x00E9, 0x00F3, 0x00FD, 0x0107, 0x0111, 0x011B, 0x0125, 0x012F, 0x0139, 0x0143, 0x014D	[4:0]	Fine Analog Delay[4:0]		24 fine delay steps. Step size = 25 ps. Values greater than 23 have no effect on analog delay.	
	[7:5]	Reserved		Reserved.	RW
0x00CC, 0x00D6, 0x00E0, 0x00EA, 0x00F4, 0x00FE, 0x0108, 0x0112, 0x011C, 0x0126, 0x0130, 0x013A, 0x0144, 0x014E	[4:0]	Coarse Digital Delay[4:0]		17 coarse delay steps. Step size = ½ VCO cycle. This flip flop (FF)-based digital delay does not increase noise level at the expense of power. Values greater than 17 have no effect on coarse delay.	
	0x00CD, 0x00D7, 0x00E1, 0x00EB, 0x00F5, 0x00FF, 0x0109, 0x0113, 0x011D, 0x0127, 0x0131, 0x013B, 0x0145, 0x014F	[7:0]	12-Bit Multislip Digital Delay[7:0] (LSB)		12-bit multislip digital delay amount LSB. Step size = (delay amount: MSB + LSB) × VCO cycles. If multislip enable bit = 1, any slip events (caused by GPI, SPI, SYNC, or pulse generator events) repeat the number of times set by 12-Bit Multislip Digital Delay[11:0] to adjust the phase by step size.

Address	Bits	Bit Name	Settings <sup>1</sup>	Description	Access
0x00CE, 0x00D8, 0x00E2, 0x00EC, 0x00F6, 0x0100, 0x010A, 0x0114, 0x011E, 0x0128, 0x0132, 0x013C, 0x0146, 0x0150	[7:4]	Reserved		Reserved.	RW
	[3:0]	12-Bit Multislip Digital Delay[11:8] (MSB)		12-bit multislip digital delay amount MSB.	
0x00CF, 0x00D9, 0x00E3, 0x00ED, 0x00F7, 0x0101, 0x010B, 0x0115, 0x011F, 0x0129, 0x0133, 0x013D, 0x0147, 0x0151	[7:2]	Reserved		Reserved.	RW
	[1:0]	Output Mux Selection[1:0]	00 01 10 11	Channel output mux selection. Channel divider output. Analog delay output. Other channel of the clock group pair. Input VCO clock (fundamental). Fundamental can also be generated with 12-Bit Channel Divider[11:0] = 1.	
0x00D0, 0x00DA, 0x00E4, 0x00EE, 0x00F8, 0x0102, 0x010C, 0x0116, 0x0120, 0x012A, 0x0134, 0x013E, 0x0148, 0x0152	[7:6]	Force Mute[1:0]	00 01 10 11	Idle at Logic 0 selection (pulse generator mode only). Force to Logic 0 or $V_{CM}$ . Normal mode (selection for DCLK). Reserved. Force to Logic 0. Reserved.	RW
	5	Dynamic driver enable	0 1	Dynamic driver enable (pulse generator mode only). Driver is enabled/disabled with channel enable bit Driver is dynamically disabled with pulse generator events.	
	[4:3]	Driver Mode[1:0]	00 01 10 11	Output driver mode selection. CML mode. LVPECL mode. LVDS mode. CMOS mode.	
	[2]	Reserved		Reserved.	
	[1:0]	Driver Impedance[1:0]	00 01 10 11	Output driver impedance selection for CML mode. Internal resistor disable. Internal 100 $\Omega$ resistor enable per output pin. Reserved. Internal 50 $\Omega$ resistor enable per output pin.	
	[7:0]	Reserved		Reserved.	
0x00D1, 0x00DB, 0x00E5, 0x00EF, 0x00F9, 0x0103, 0x010D, 0x0117, 0x0121, 0x012B, 0x0135, 0x013F, 0x0149, 0x0153	[7:0]	Reserved		Reserved.	RW

<sup>1</sup> X means don't care.

# EVALUATION PCB SCHEMATIC

## EVALUATION PCB

For the circuit board used in the application, use RF circuit design techniques. Ensure that signal lines have 50 Ω impedance. Connect the package ground leads and exposed pad directly to the ground plane (see Figure 52). Use a sufficient number of via holes to connect the top and bottom ground planes. The evaluation circuit board is available from Analog Devices upon request.

The typical Pb-free reflow solder profile is shown in Figure 51.

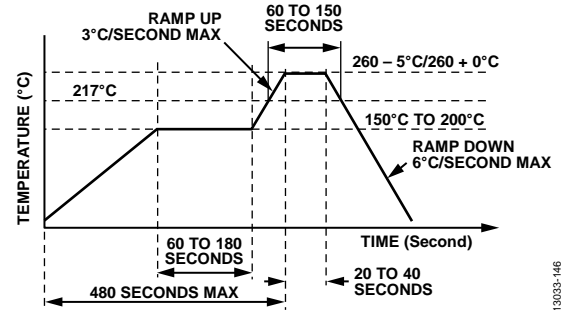

Figure 51. Pb-Free Reflow Solder Profile

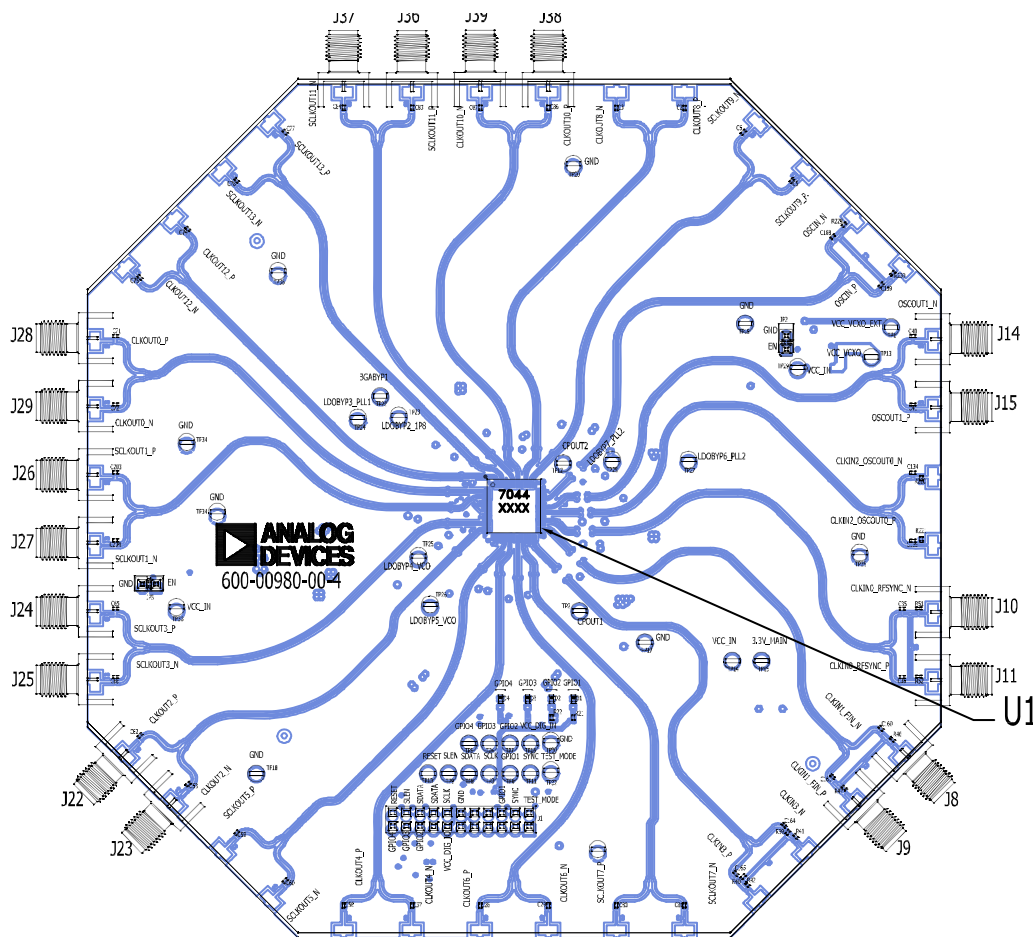

Figure 52. Evaluation PCB Layout, Top Side

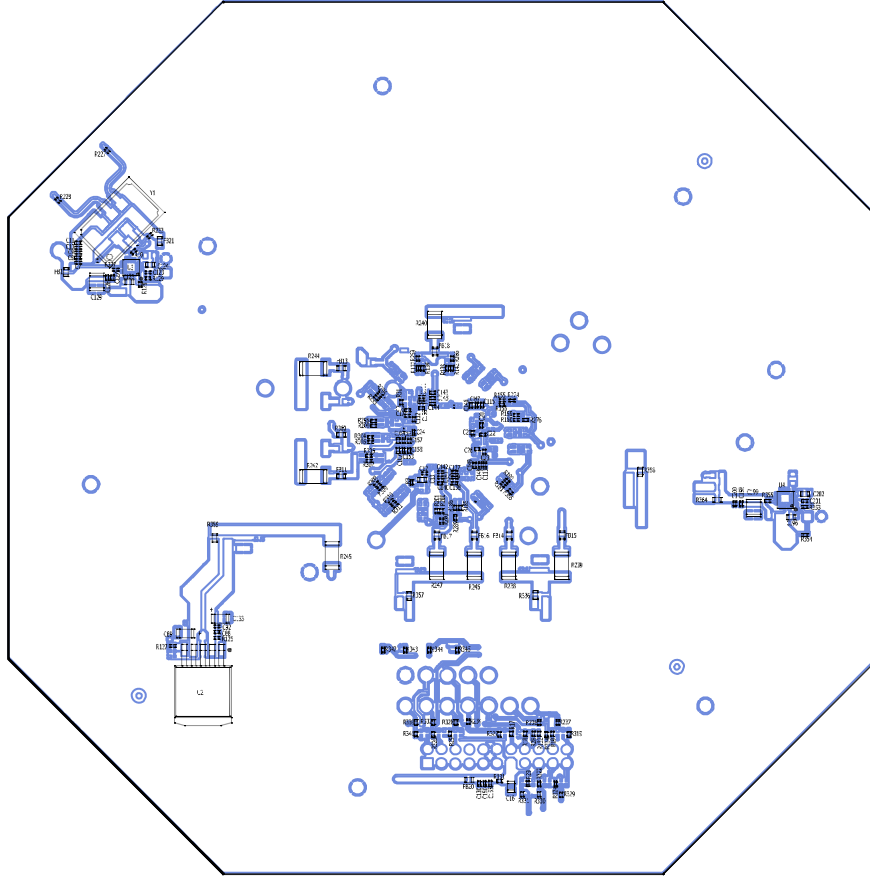
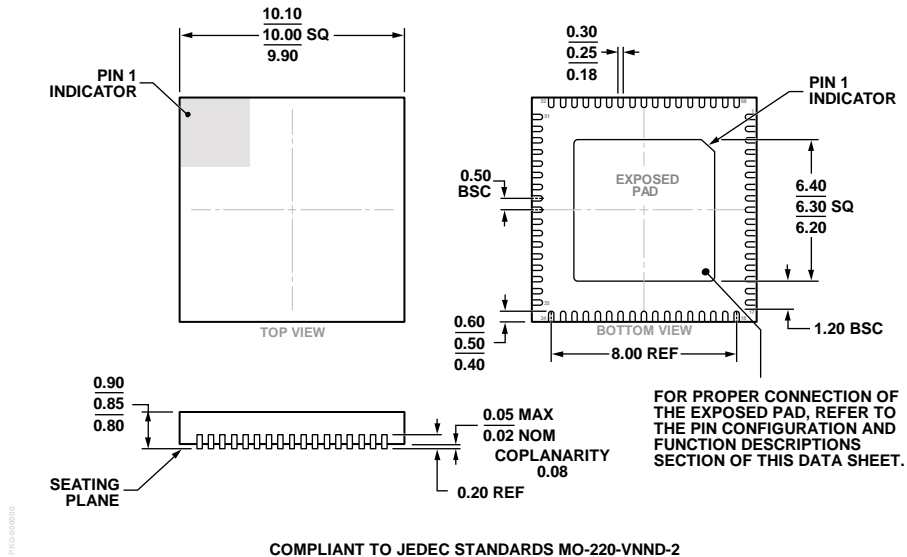

Figure 53. Evaluation PCB Layout, Bottom Side

13033-049

# OUTLINE DIMENSIONS



COMPLIANT TO JEDEC STANDARDS MO-220-VNND-2  
 Figure 54. 68-Lead Lead Frame Chip Scale Package [LFCSP\_VQ]  
 10 mm x 10 mm Body, Very Thin Quad  
 (HCP-68-1)  
 Dimensions shown in millimeters

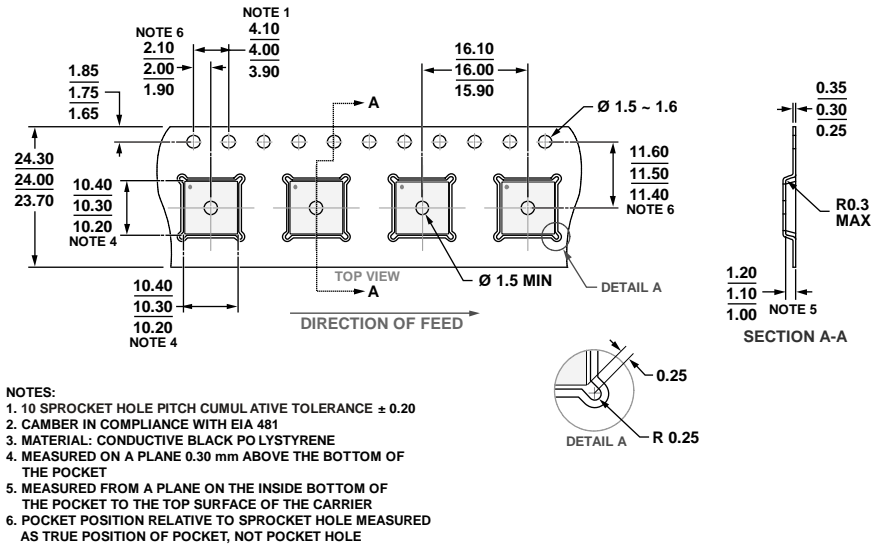

Figure 55. LFCSP Tape and Reel Outline Dimensions  
 Dimensions shown in millimeters

## ORDERING GUIDE

Model <sup>1</sup>	Temperature Range	Lead Finish	MSL Rating	Package Description	Package Option	Branding <sup>2</sup>
HMC7044LP10BE	-40°C to +85°C	100% matte tin	MSL-3	68-Lead LFCSP_VQ	HCP-68-1	<u>7044</u> XXXX
HMC7044LP10BETR	-40°C to +85°C	100% matte tin	MSL-3	68-Lead LFCSP_VQ	HCP-68-1	<u>7044</u> XXXX
EK1HMC7044LP10B	-40°C to +85°C			Evaluation Kit		

<sup>1</sup> E = RoHS Compliant Part.

<sup>2</sup> Four-digit lot number represented by XXXX.

**NOTES**