

## 1200 V power Schottky silicon carbide diode

Datasheet - production data

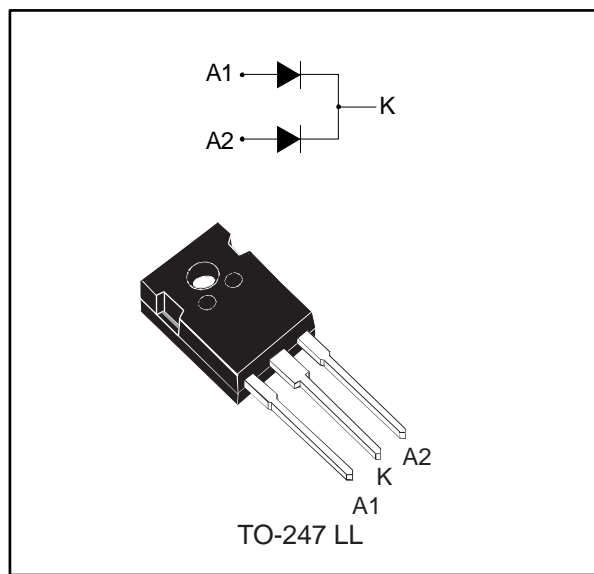

### Description

The SiC diode, available in TO-247 LL, is an ultrahigh performance power Schottky rectifier. It is manufactured using a silicon carbide substrate. The wide band-gap material allows the design of a low  $V_F$  Schottky diode structure with a 1200 V rating. Due to the Schottky construction, no recovery is shown at turn-off and ringing patterns are negligible. The minimal capacitive turn-off behavior is independent of temperature.

Especially suited for use in PFC and secondary side applications, this ST SiC diode will boost the performance in hard switching conditions. This rectifier will enhance the performance of the targeted application. Its high forward surge capability ensures a good robustness during transient phases.

### Features

- No or negligible reverse recovery
- Switching behavior independent of temperature
- Robust high voltage periphery
- Operating  $T_j$  from -40 °C to 175 °C
- ECOPACK<sup>®</sup>2 compliant

Table 1: Device summary

Symbol	Value
$I_{F(AV)}$	2 x 15 A
$V_{RRM}$	1200 V
$T_j$ (max.)	175 °C
$V_F$ (typ.)	1.35 V

# 1 Characteristics

**Table 2: Absolute ratings (limiting values per diode at 25 °C, unless otherwise specified)**

Symbol	Parameter		Value	Unit	
V <sub>RRM</sub>	Repetitive peak reverse voltage (T <sub>j</sub> = -40 °C to +175 °C)		1200	V	
I <sub>F(RMS)</sub>	Forward rms current		38	A	
I <sub>F(AV)</sub>	Average forward current	T <sub>C</sub> = 150 °C DC current	Per diode/per device	15/30	A
		T <sub>C</sub> = 135 °C DC current		21/42	
		T <sub>C</sub> = 25 °C DC current		38/76	
I <sub>FRM</sub>	Repetitive peak forward current	T <sub>C</sub> = 150 °C, T <sub>j</sub> = 175 °C, δ = 0.1	61	A	
I <sub>FSM</sub>	Surge non repetitive forward current	t <sub>p</sub> = 10 ms sinusoidal	T <sub>C</sub> = 25 °C	105	A
			T <sub>C</sub> = 150 °C	90	
		t <sub>p</sub> = 10 μs square	T <sub>C</sub> = 25 °C	630	
T <sub>stg</sub>	Storage temperature range		-65 to +175	°C	
T <sub>j</sub>	Operating junction temperature range		-40 to +175	°C	

**Table 3: Thermal resistance parameters**

Symbol	Parameter	Typ. value	Max. value	Unit	
R <sub>th(j-c)</sub>	Junction to case	Per diode	0.50	0.70	°C/W
		Per device	0.25	0.35	

**Table 4: Static electrical characteristics (per diode)**

Symbol	Parameter	Test conditions		Min.	Typ.	Max.	Unit
I <sub>R</sub> <sup>(1)</sup>	Reverse leakage current	T <sub>j</sub> = 25 °C	V <sub>R</sub> = V <sub>RRM</sub>	-	7.5	90	μA
		T <sub>j</sub> = 150 °C		-	45	600	
V <sub>F</sub> <sup>(2)</sup>	Forward voltage drop	T <sub>j</sub> = 25 °C	I <sub>F</sub> = 15 A	-	1.35	1.50	V
		T <sub>j</sub> = 150 °C		-	1.75	2.25	

**Notes:**

(1)Pulse test: t<sub>p</sub> = 10 ms, δ < 2%

(2)Pulse test: t<sub>p</sub> = 500 μs, δ < 2%

To evaluate the conduction losses, use the following equation:

$$P = 1.09 \times I_{F(AV)} + 0.0775 \times I_{F(RMS)}^2$$

Table 5: Dynamic electrical characteristics (per diode)

Symbol	Parameter	Test conditions	Min.	Typ.	Max.	Unit
$Q_{Cj}^{(1)}$	Total capacitive charge	$V_R = 800 \text{ V}$	-	94	-	nC
$C_j$	Total capacitance	$V_R = 0 \text{ V}, T_c = 25 \text{ }^\circ\text{C}, F = 1 \text{ MHz}$	-	1200	-	pF
		$V_R = 800 \text{ V}, T_c = 25 \text{ }^\circ\text{C}, F = 1 \text{ MHz}$	-	78	-	

**Notes:**

<sup>(1)</sup>Most accurate value for the capacitive charge:  $Q_{Cj}(V_R) = \int_0^{V_R} C_j(V) dV$

### 1.1 Characteristics (curves)

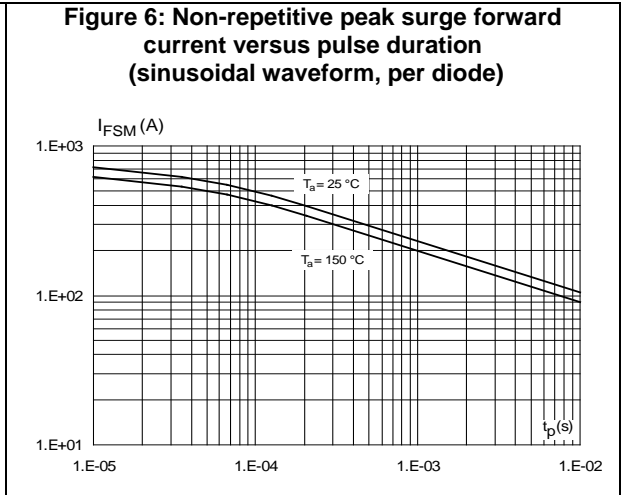
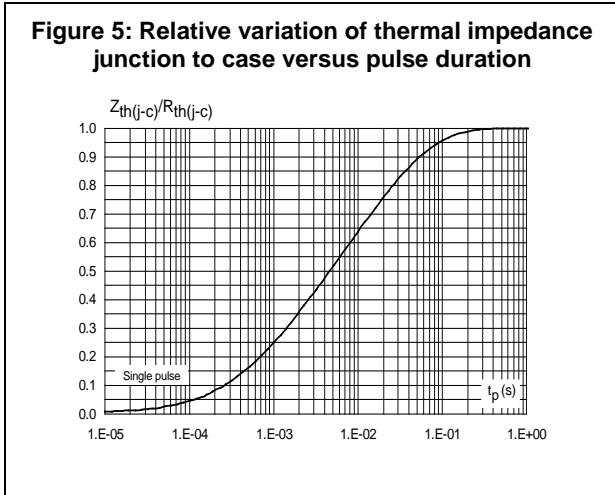
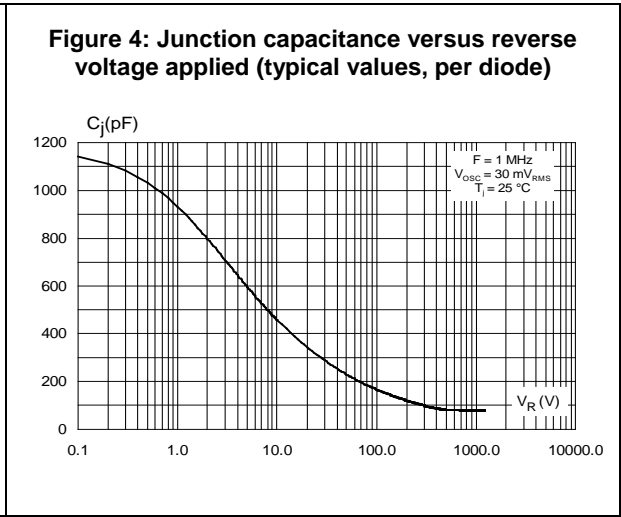
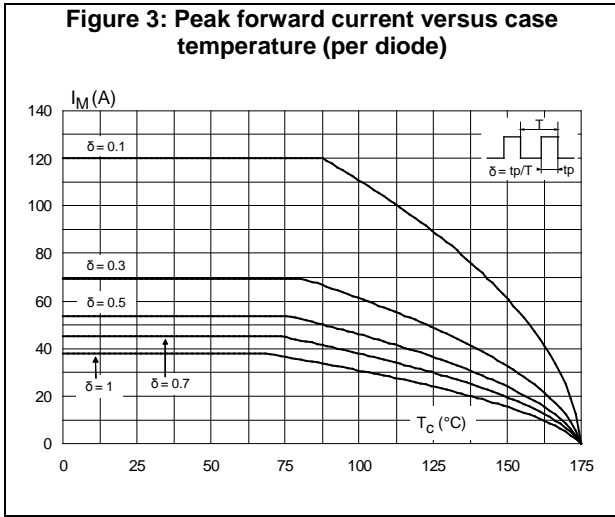
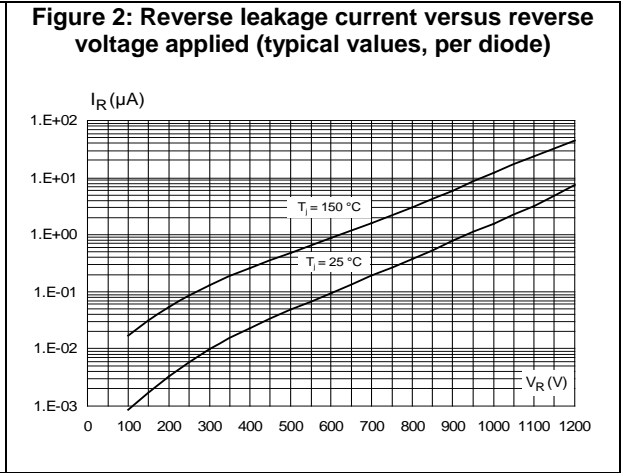
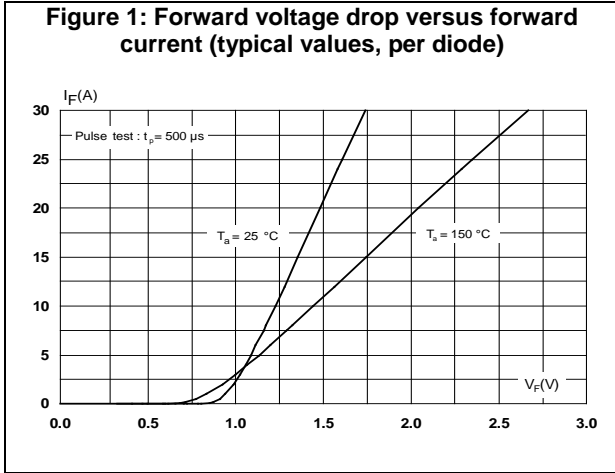
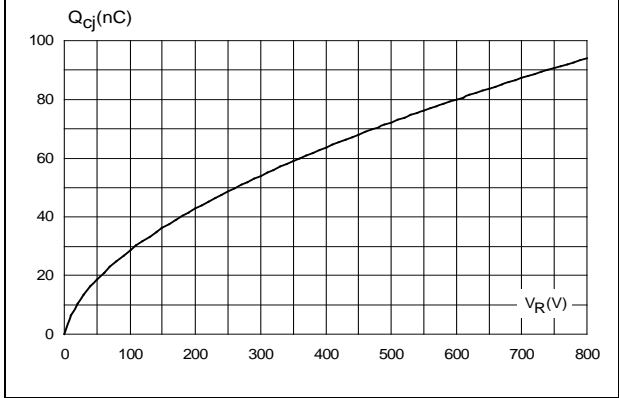

Figure 7: Total capacitive charges versus reverse voltage applied (typical values, per diode)



## 2 Package information

In order to meet environmental requirements, ST offers these devices in different grades of ECOPACK® packages, depending on their level of environmental compliance. ECOPACK® specifications, grade definitions and product status are available at: [www.st.com](http://www.st.com). ECOPACK® is an ST trademark.

- Epoxy meets UL94, V0
- Cooling method: by conduction (C)
- Recommended torque value: 0.9 to 1.2 N·m

### 2.1 TO-247 long leads package information

Figure 8: TO-247 long leads package outline

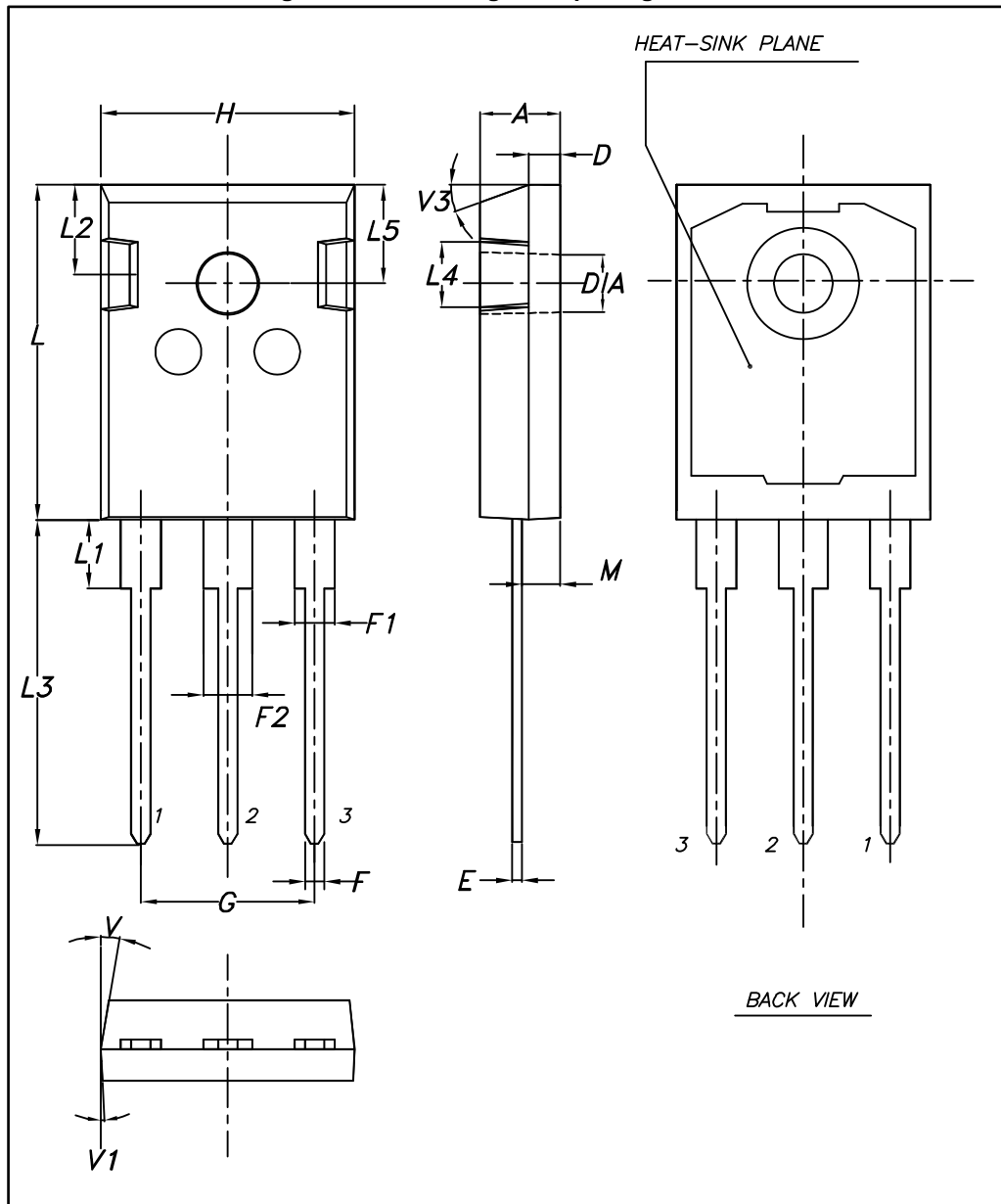

Table 6: TO-247 long leads package mechanical data

Dim.	mm.			Inches		
	Min.	Typ.	Max.	Min.	Typ.	Max.
A	4.90		5.15	0.192		0.202
D	1.85		2.10	0.072		0.082
E	0.55		0.67	0.021		0.026
F	1.07		1.32	0.042		0.051
F1	1.90		2.38	0.074		0.093
F2	2.87		3.38	0.110		0.133
G	10.90 BSC			0.429 BSC		
H	15.77		16.02	0.620		0.630
L	20.82		21.07	0.810		0.820
L1	4.16		4.47	0.163		0.175
L2	5.49		5.74	0.216		0.225
L3	20.05		20.30	0.789		0.799
L4	3.68		3.93	0.144		0.154
L5	6.04		6.29	0.237		0.247
M	2.25		2.55	0.088		0.100
V		10°			10°	
V1		3°			3°	
V3		20°			20°	
DIA	3.55		3.66	0.139		0.143

### 3 Ordering information

Table 7: Ordering information

Order code	Marking	Package	Weight	Base qty.	Delivery mode
STPSC30H12CWL	STPSC30H12CWL	TO-247 LL	6.09 g	30	Tube

### 4 Revision history

Table 8: Document revision history

Date	Revision	Changes
15-Feb-2017	1	Initial release.



**IMPORTANT NOTICE – PLEASE READ CAREFULLY**

STMicroelectronics NV and its subsidiaries ("ST") reserve the right to make changes, corrections, enhancements, modifications, and improvements to ST products and/or to this document at any time without notice. Purchasers should obtain the latest relevant information on ST products before placing orders. ST products are sold pursuant to ST's terms and conditions of sale in place at the time of order acknowledgement.

Purchasers are solely responsible for the choice, selection, and use of ST products and ST assumes no liability for application assistance or the design of Purchasers' products.

No license, express or implied, to any intellectual property right is granted by ST herein.

Resale of ST products with provisions different from the information set forth herein shall void any warranty granted by ST for such product.

ST and the ST logo are trademarks of ST. All other product or service names are the property of their respective owners.

Information in this document supersedes and replaces information previously supplied in any prior versions of this document.

© 2017 STMicroelectronics – All rights reserved