

Digital Transistors (Built-in Resistors)

EMD12 Dual Digital Transistors (NPN+PNP)

FEATURES

- Both the DTC144E chip and DTA144E chip in a package.
- Mounting possible with SOT-563 automatic mounting machines.
- Transistor elements are independent, eliminating interference.
- Mounting cost and area be cut in half.

Marking: D12

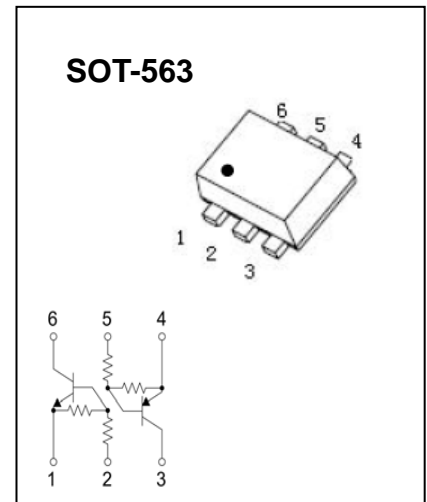

T_{R1} Absolute maximum ratings (Ta=25°C)

Parameter	Symbol	Limits	Unit
Supply voltage	V _{CC}	50	V
Input voltage	V _{IN}	-10~40	V
Output current	I _o	100	mA
	I _{C(MAX)}	100	
Power dissipation	Pd	150	mW
Junction temperature	T _j	150	°C
Storage temperature	T _{stg}	-55~150	°C

T_{R1} Electrical characteristics (Ta=25°C)

Parameter	Symbol	Min.	Typ	Max.	Unit	Conditions
Input voltage	V _{I(off)}	0.5			V	V _{CC} =5V, I _o =100μA
	V _{I(on)}			3		V _O =0.3V, I _o =2mA
Output voltage	V _{O(on)}		0.1	0.3	V	I _o /I _i =10mA/0.5mA
Input current	I _i			0.18	mA	V _i =5V
Output current	I _{O(off)}			0.5	μA	V _{CC} =50V, V _i =0
DC current gain	G _i	68				V _O =5V, I _o =5mA
Input resistance	R ₁	32.9	47	61.1	KΩ	-
Resistance ratio	R ₂ /R ₁	0.8	1	1.2		-
Transition frequency	f _T		250		MHz	V _{CE} =10V, I _E =5mA, f=100MHz

T_{R2} Absolute maximum ratings (Ta=25°C)

Parameter	Symbol	Limits	Unit
Supply voltage	V _{CC}	-50	V
Input voltage	V _{IN}	-40~10	V
Output current	I _O	-100	mA
	I _{C(MAX)}	-100	
Power dissipation	P _d	150	mW
Junction temperature	T _j	150	°C
Storage temperature	T _{stg}	-55~150	°C

T_{R2} Electrical characteristics (Ta=25°C)

Parameter	Symbol	Min.	Typ	Max.	Unit	Conditions
Input voltage	V _{I(off)}	-0.5			V	V _{CC} =-5V, I _O =-100μA
	V _{I(on)}			-3		V _O =-0.3V, I _O =-2mA
Output voltage	V _{O(on)}		-0.1	-0.3	V	I _O /I _I =-10mA/-0.5mA
Input current	I _I			-0.18	mA	V _I =-5V
Output current	I _{O(off)}			-0.5	μA	V _{CC} =-50V, V _I =0
DC current gain	G ₁	68				V _O =-5V, I _O =-5mA
Input resistance	R ₁	32.9	47	61.1	KΩ	-
Resistance ratio	R ₂ /R ₁	0.8	1	1.2		-
Transition frequency	f _T		250		MHz	V _{CE} =-10V, I _E =-5mA, f=100MHz

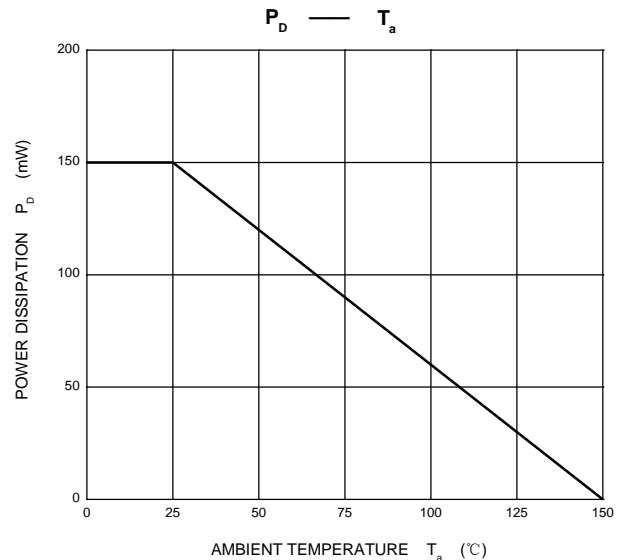
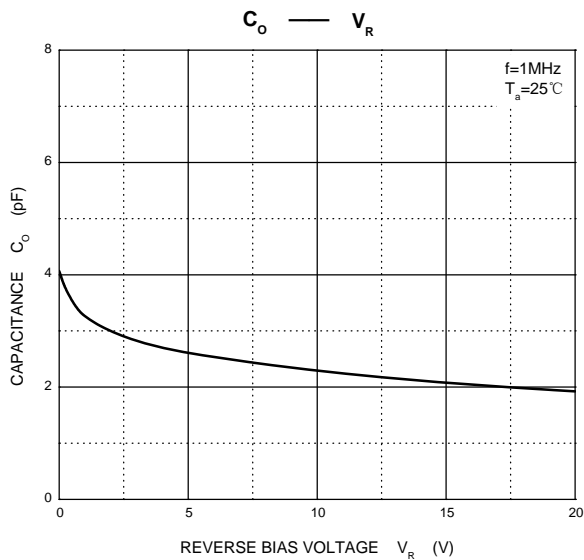
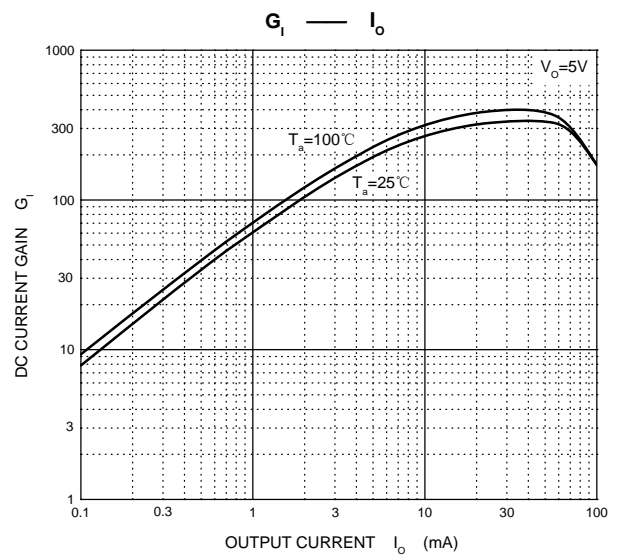
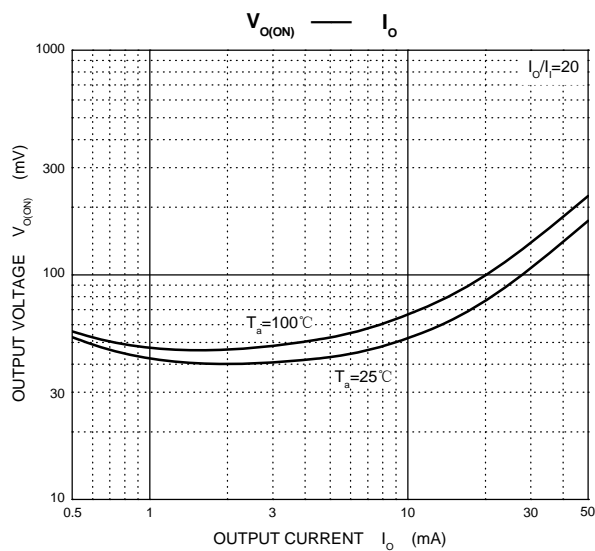
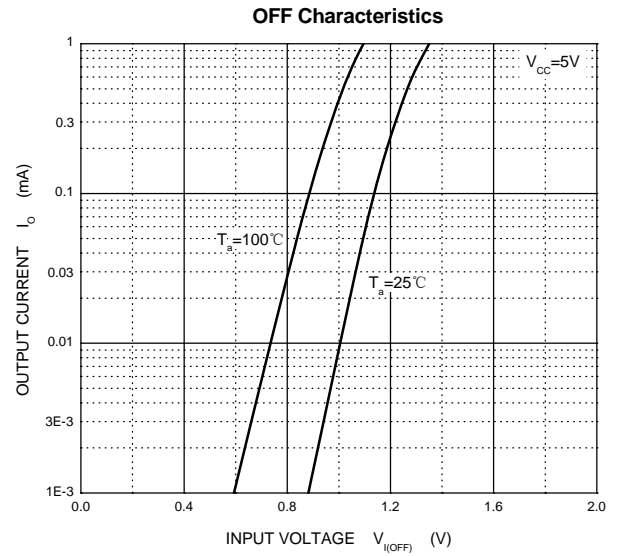
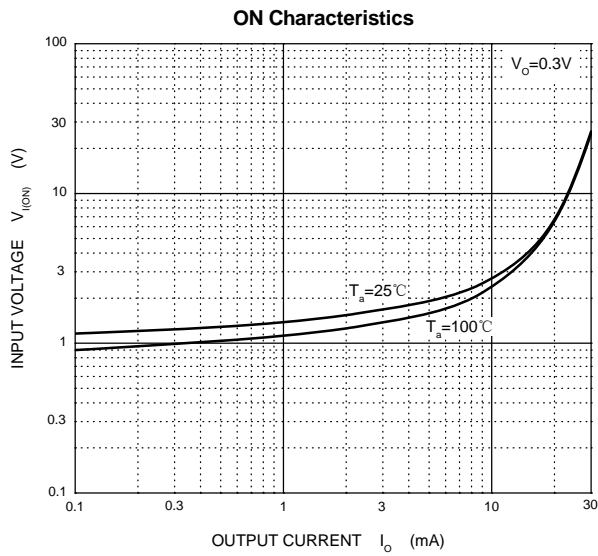

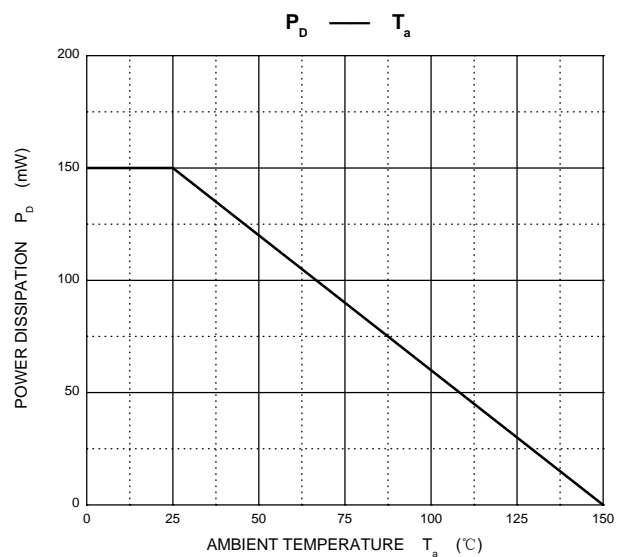
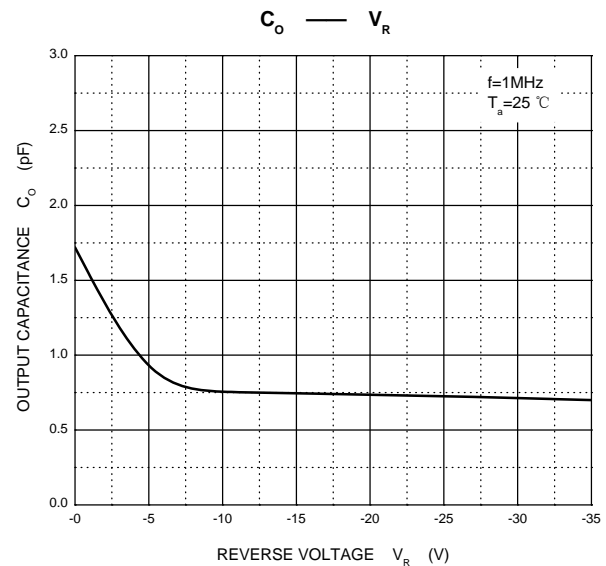
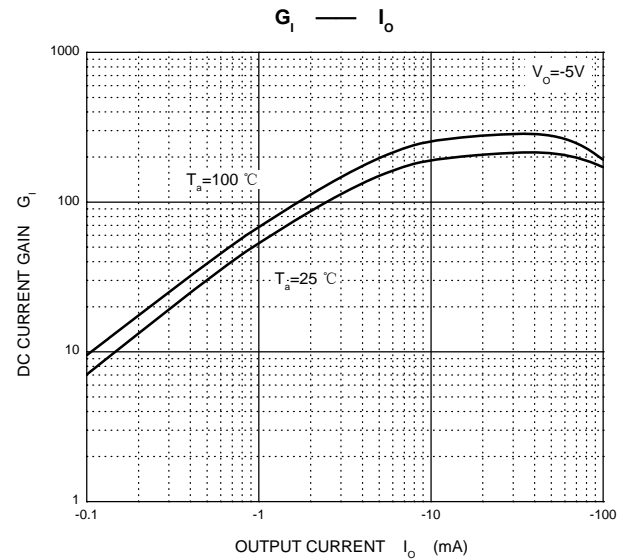
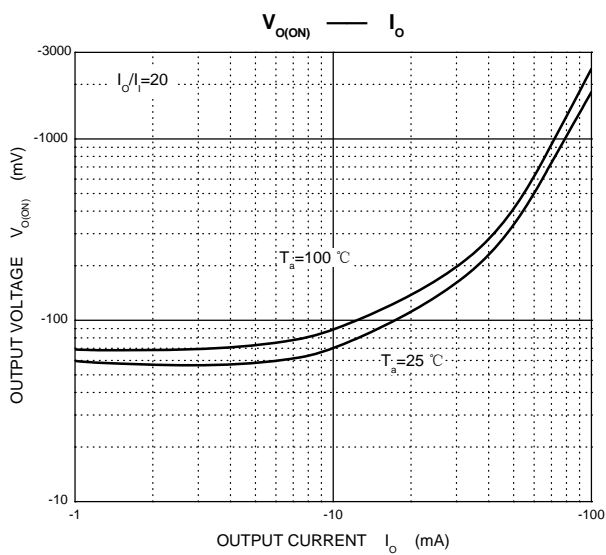
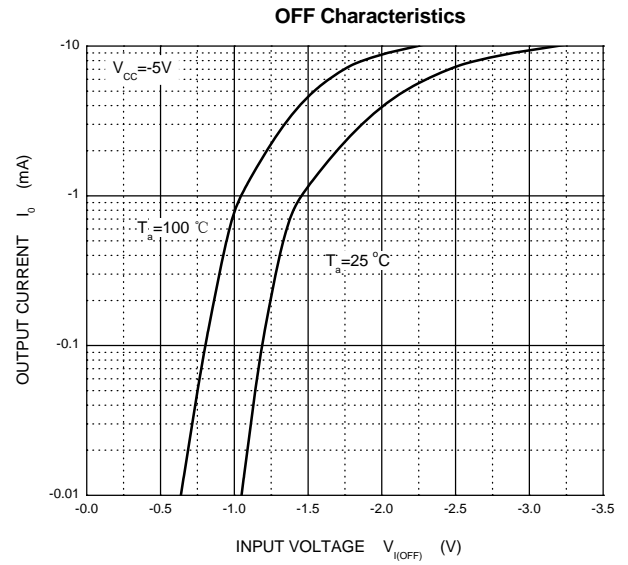
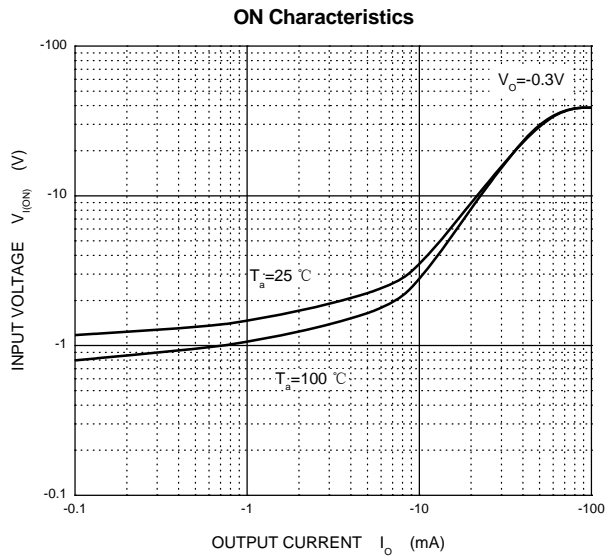

SOT-563 Package Outline Dimensions

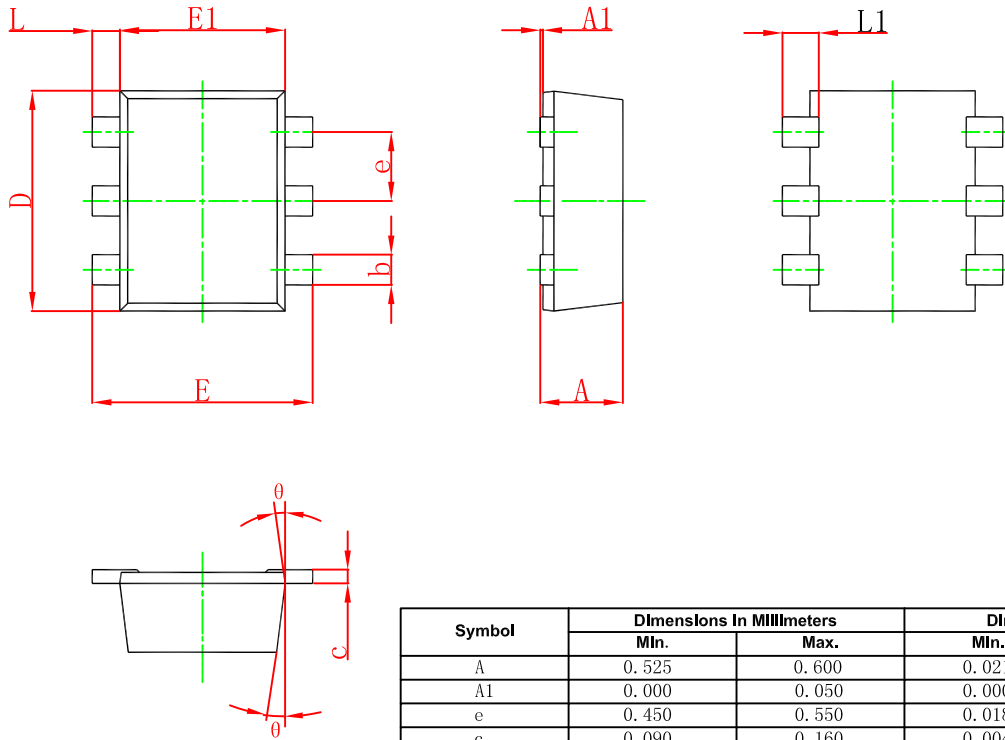

Symbol	Dimensions In Millimeters		Dimensions In Inches	
	Min.	Max.	Min.	Max.
A	0.525	0.600	0.021	0.024
A1	0.000	0.050	0.000	0.002
e	0.450	0.550	0.018	0.022
c	0.090	0.160	0.004	0.006
D	1.500	1.700	0.059	0.067
b	0.170	0.270	0.007	0.011
E1	1.100	1.300	0.043	0.051
E	1.500	1.700	0.059	0.067
L	0.100	0.300	0.004	0.012
L1	0.200	0.400	0.008	0.016
θ	7 °REF.		7 °REF.	

SOT-563 Suggested Pad Layout

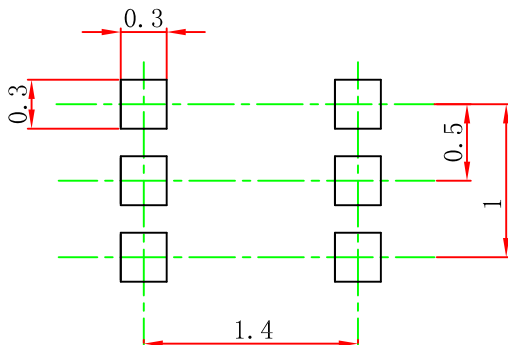

Note:

1. Controlling dimension: in millimeters.
2. General tolerance: $\pm 0.05\text{mm}$.
3. The pad layout is for reference purposes only.

NOTICE

JCET reserve the right to make modifications, enhancements, improvements, corrections or other changes without further notice to any product herein. JCET does not assume any liability arising out of the application or use of any product described herein.

SOT-563 Tape and Reel

SOT-563 Embossed Carrier Tape

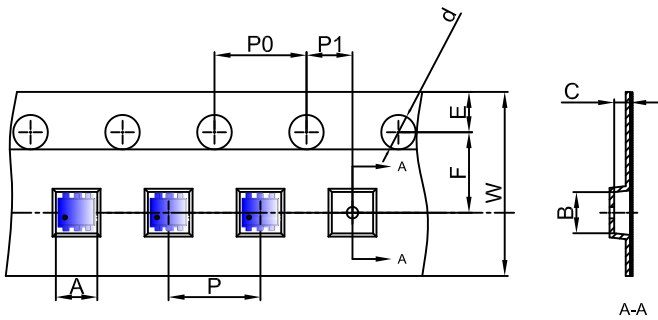

Packaging Description:
 SOT-563 parts are shipped in tape. The carrier tape is made from a dissipative (carbon filled) polycarbonate resin. The cover tape is a multilayer film (Heat Activated Adhesive in nature) primarily composed of polyester film, adhesive layer, sealant, and anti-static sprayed agent. These reeled parts in standard option are shipped with 3,000 units per 7" or 17.8cm diameter reel. The reels are clear in color and is made of polystyrene plastic (anti-static coated).

Dimensions are in millimeter										
Pkg type	A	B	C	d	E	F	P0	P	P1	W
SOT-563	1.78	1.78	0.69	Ø1.50	1.75	3.50	4.00	4.00	2.00	8.00

SOT-563 Tape Leader and Trailer

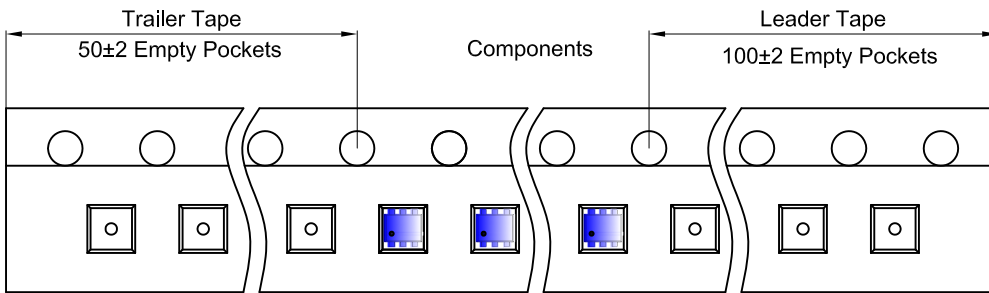

SOT-563 Reel

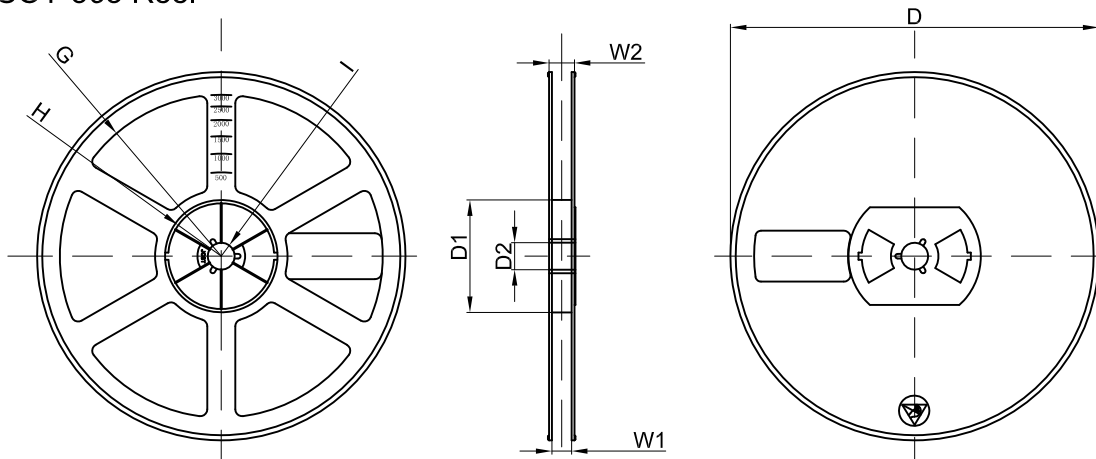

Dimensions are in millimeter								
Reel Option	D	D1	D2	G	H	I	W1	W2
7"Dia	Ø178.00	54.40	13.00	R78.00	R25.60	R6.50	9.50	12.30

REEL	Reel Size	Box	Box Size(mm)	Carton	Carton Size(mm)	G.W.(kg)
3000 pcs	7 inch	45,000 pcs	203×203×195	180,000 pcs	438×438×220	