

Dual IGBT HVIGBT Module 150 Amperes/4500 Volts

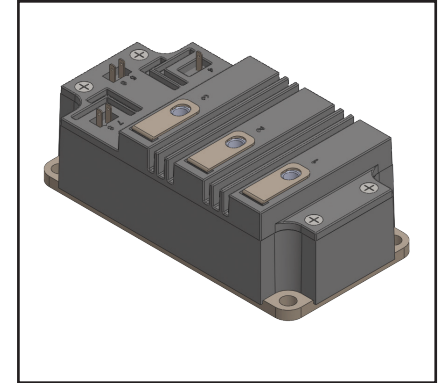
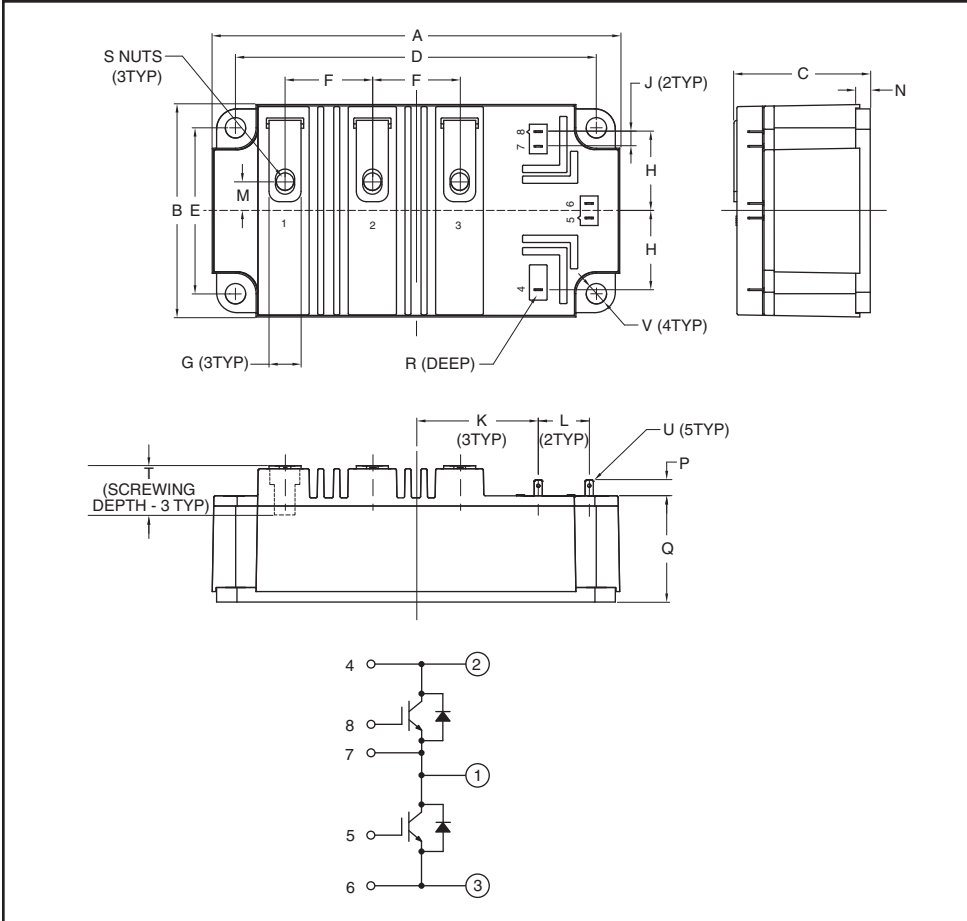

Description:

Powerex HVIGBTs feature highly insulating housings that offer enhanced protection by means of greater creepage and strike clearance distance for many demanding applications like medium voltage drives and auxiliary traction applications.

Features:

- 40 to 150°C Extended Temperature Range
- 100% Dynamic Tested
- 100% Partial Discharge Tested
- Advanced Mitsubishi R-Series Chip Technology
- Aluminum Nitride (AlN) Ceramic Substrate for Low Thermal Impedance
- Complementary Line-up in Expanding Current Ranges to Mitsubishi HVIGBT Power Modules
- Copper Baseplate
- Creepage and Clearance Meet IEC 60077-1
- Rugged SWSOA and RRSOA

Applications:

- High Voltage Power Supplies
- Medium Voltage Drives
- Motor Drives
- Traction

Outline Drawing and Circuit Diagram

Dimensions	Inches	Millimeters
A	5.51	140.0
B	2.87	73.0
C	1.50	38.0
D	4.88±0.01	124.0±0.25
E	2.24±0.01	57.0±0.25
F	1.18	30.0
G	0.43	11.0
H	1.07	27.15
J	0.20	5.0
K	1.65	42.0

Dimensions	Inches	Millimeters
L	0.69±0.01	17.5±0.25
M	0.38	9.75
N	0.20	5.0
P	0.22	5.5
Q	1.04	26.5
R	0.16	4.0
S	M5 Metric	M5
T	0.63 Min.	16.0 Min.
U	0.11 x 0.02	2.8 x 0.5
V	0.28 Dia.	7.0 Dia.

QID4515004
Dual IGBT HVIGBT Module
 150 Amperes/4500 Volts

Absolute Maximum Ratings, $T_j = 25\text{ }^\circ\text{C}$ unless otherwise specified

Ratings	Symbol	QID4515004	Units
Junction Temperature	T_j	-40 to 150	$^\circ\text{C}$
Storage Temperature	T_{stg}	-40 to 125	$^\circ\text{C}$
Collector-Emitter Voltage ($V_{GE} = 0\text{V}$, $T_j = -40$ to $+125^\circ\text{C}$)	V_{CES}	4500	Volts
Collector-Emitter Voltage ($V_{GE} = 0\text{V}$, $T_j = -50^\circ\text{C}$)	V_{CES}	4400	Volts
Gate-Emitter Voltage ($V_{CE} = 0\text{V}$)	V_{GES}	± 20	Volts
Collector Current, DC ($T_C = 82^\circ\text{C}$)	I_C	150	Amperes
Peak Collector Current (Pulse)	I_{CM}	300*	Amperes
Diode Forward Current**	I_F	150	Amperes
Diode Forward Surge Current** (Pulse)	I_{FM}	300*	Amperes
I^2t for Diode ($t = 10\text{ms}$)	I^2t	10	kA^2sec
Maximum Collector Dissipation ($T_C = 25^\circ\text{C}$, IGBT Part, $T_{j(\text{max})} \leq 150^\circ\text{C}$)	P_C	1580	Watts
Mounting Torque, M5 Terminal Screws	—	35	in-lb
Mounting Torque, M6 Mounting Screws	—	44	in-lb
Module Weight (Typical)	—	800	Grams
Isolation Voltage (Charged Part to Baseplate, AC 60Hz 1 min.)	V_{iso}	6.0	kVolts
Partial Discharge ($V_1 = 3500\text{ V}_{RMS}$, $V_2 = 2600\text{ V}_{RMS}$, $f = 60\text{Hz}$ (Acc. to IEC 1287))	Q_{pd}	10	pC
Maximum Short-Circuit Pulse Width, ($V_{CC} \leq 3200\text{V}$, $V_{GE} = 15\text{V}$, $T_j = 125^\circ\text{C}$)	t_{psc}	10	μs

Electrical Characteristics, $T_j = 25\text{ }^\circ\text{C}$ unless otherwise specified

Characteristics	Symbol	Test Conditions	Min.	Typ.	Max.	Units
Collector-Cutoff Current	I_{CES}	$V_{CE} = V_{CES}$, $V_{GE} = 0\text{V}$	—	—	1.8	mA
Gate Leakage Current	I_{GES}	$V_{GE} = V_{GES}$, $V_{CE} = 0\text{V}$	—	—	0.5	μA
Gate-Emitter Threshold Voltage	$V_{GE(\text{th})}$	$I_C = 13.3\text{mA}$, $V_{CE} = 10\text{V}$	5.8	6.3	6.8	Volts
Collector-Emitter Saturation Voltage	$V_{CE(\text{sat})}$	$I_C = 150\text{A}$, $V_{GE} = 15\text{V}$, $T_j = 25^\circ\text{C}$	—	3.8	—	Volts
		$I_C = 150\text{A}$, $V_{GE} = 15\text{V}$, $T_j = 125^\circ\text{C}$	—	4.6	5.5	Volts
Total Gate Charge	Q_G	$V_{CC} = 2800\text{V}$, $I_C = 150\text{A}$, $V_{GE} = 15\text{V}$	—	1.5	—	μC
Emitter-Collector Voltage**	V_{EC}	$I_E = 150\text{A}$, $V_{GE} = 0\text{V}$, $T_j = 25^\circ\text{C}$	—	2.8	—	Volts
		$I_E = 150\text{A}$, $V_{GE} = 0\text{V}$, $T_j = 125^\circ\text{C}$	—	3.2	3.8	Volts

* Pulse width and repetition rate should be such that device junction temperature (T_j) does not exceed $T_{j(\text{max})}$ rating.

**Represents characteristics of rhw anti-parallel, emitter-to-collector free-wheel diode (FWDI).

QID4515004
Dual IGBT HVIGBT Module
 150 Amperes/4500 Volts

Electrical Characteristics, $T_j = 25\text{ }^\circ\text{C}$ unless otherwise specified

Characteristics	Symbol	Test Conditions	Min.	Typ.	Max.	Units
Input Capacitance	C_{ies}		—	19	—	nF
Output Capacitance	C_{oes}	$V_{GE} = 0V, V_{CE} = 10V, f = 100kHz$	—	1.22	—	nF
Reverse Transfer Capacitance	C_{res}		—	0.55	—	nF
Turn-on Delay Time	$t_{d(on)}$	$V_{CC} = 2800V, I_C = 133A,$	—	1.00	—	μs
Rise Time	t_r	$V_{GE} = \pm 15V, R_{G(on)} = 24.3\Omega,$	—	0.30	—	μs
Turn-off Delay Time	$t_{d(off)}$	$R_{G(off)} = 90\Omega, L_S = 150nH$	—	3.6	—	μs
Fall Time	t_f	Inductive Load	—	0.36	—	μs
Turn-on Switching Energy	E_{on}	$T_j = 125^\circ C, I_C = 133A, V_{GE} = \pm 15V,$	—	0.55	—	J/P
Turn-off Switching Energy	E_{off}	$R_{G(on)} = 24.3\Omega, R_{G(off)} = 90\Omega,$ $V_{CC} = 2800V, L_S = 150nH, \text{ Inductive Load}$	—	0.34	—	J/P
Diode Reverse Recovery Time**	t_{rr}	$V_{CC} = 2800V, I_E = 133A,$	—	0.7	—	μs
Diode Reverse Recovery Charge**	Q_{rr}	$V_{GE} = \pm 15V, R_{G(on)} = 24.3\Omega,$	—	111*	—	μC
Diode Reverse Recovery Energy	E_{rec}	$L_S = 150nH, \text{ Inductive Load}$	—	172	—	mJ/P
Stray Inductance (C1-E2)	L_{SCE}		—	60	—	nH
Lead Resistance Terminal-Chip	R_{CE}		—	0.8	—	m Ω

Thermal and Mechanical Characteristics, $T_j = 25\text{ }^\circ\text{C}$ unless otherwise specified

Characteristics	Symbol	Test Conditions	Min.	Typ.	Max.	Units
Thermal Resistance, Junction to Case***	$R_{th(j-c)} Q$	Per IGBT	—	—	0.079	$^\circ K/W$
Thermal Resistance, Junction to Case***	$R_{th(j-c)} D$	Per FWDi	—	—	0.149	$^\circ K/W$
Contact Thermal Resistance, Case to Fin	$R_{th(c-f)}$	Per Module, Thermal Grease Applied, $\lambda_{grease} = 1W/mK$	—	0.018	—	$^\circ K/W$
Comparative Tracking Index	CTI		600	—	—	
Clearance Distance in Air (Terminal to Base)	$d_{a(t-b)}$		35.0	—	—	mm
Clearance Distance in Air (Terminal to Terminal)	$d_{a(t-t)}$		19	—	—	mm
Creepage Distance Along Surface (Terminal to Terminal)	$d_{s(t-t)}$		54	—	—	mm

*Pulse width and repetition rate should be such that device junction temperature rise is negligible.

**Represents characteristics of the anti-parallel, emitter-to-collector free-wheel diode (FWDi).

*** T_C measurement point is just under the chips.

QID4515004
Dual IGBT HVIGBT Module
 150 Amperes/4500 Volts

OUTPUT CHARACTERISTICS (TYPICAL)

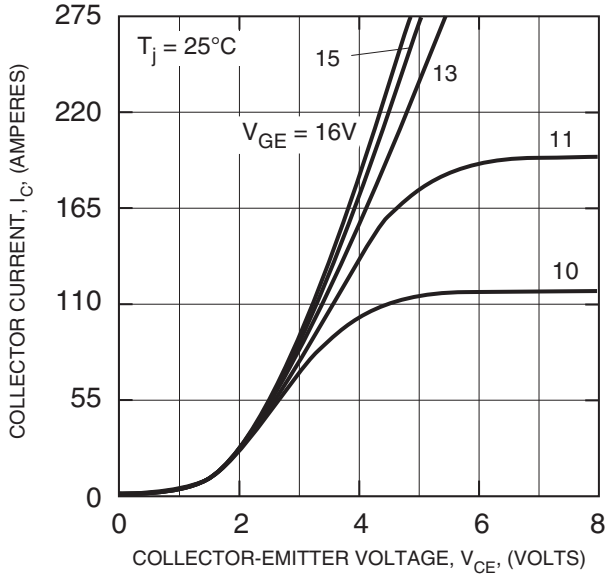

COLLECTOR-EMITTER SATURATION VOLTAGE CHARACTERISTICS (TYPICAL)

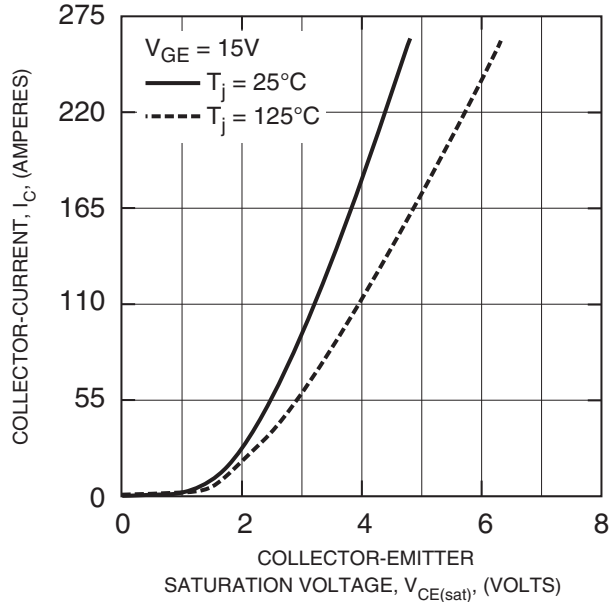

TRANSFER CHARACTERISTICS (TYPICAL)

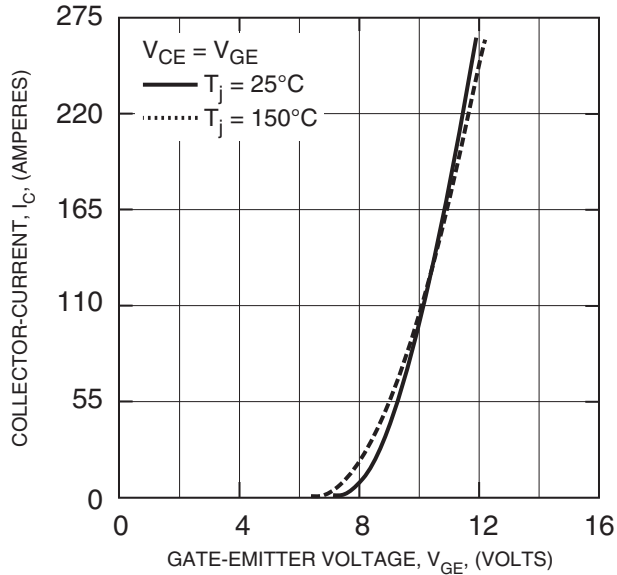

FREE-WHEEL DIODE FORWARD CHARACTERISTICS (TYPICAL)

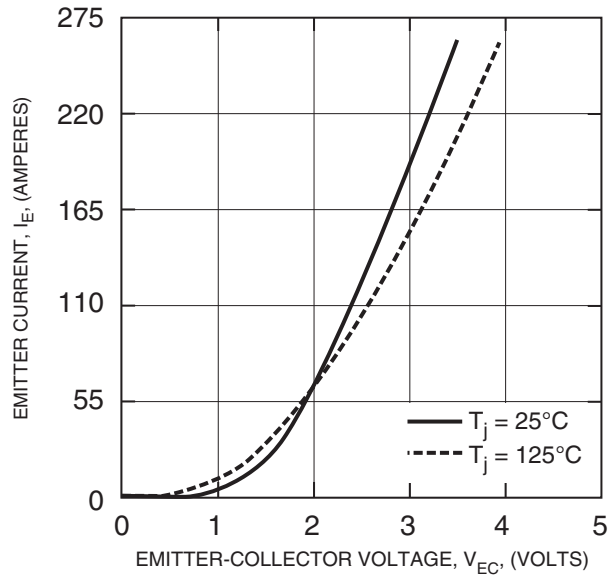

QID4515004
Dual IGBT HVIGBT Module
 150 Amperes/4500 Volts

CAPACITANCE VS. V_{CE}
 (TYPICAL)

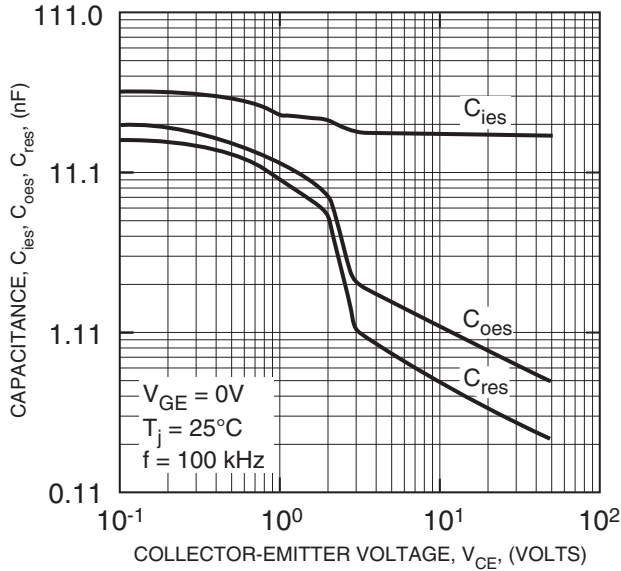

GATE CHARGE VS. V_{GE}

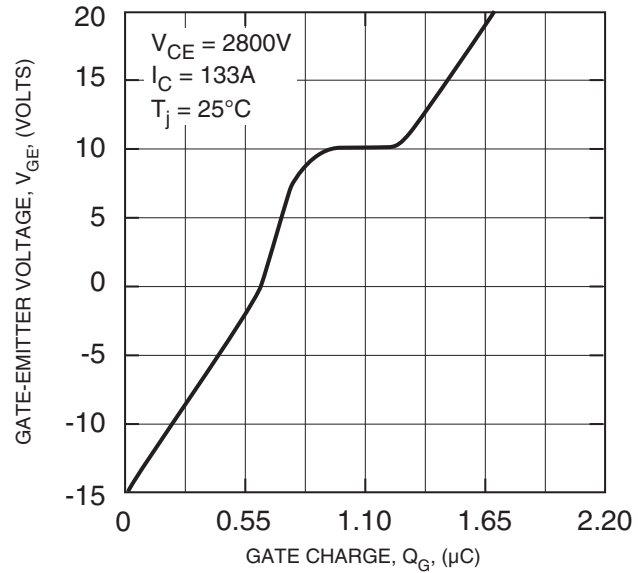

HALF-BRIDGE SWITCHING ENERGY CHARACTERISTICS (TYPICAL)

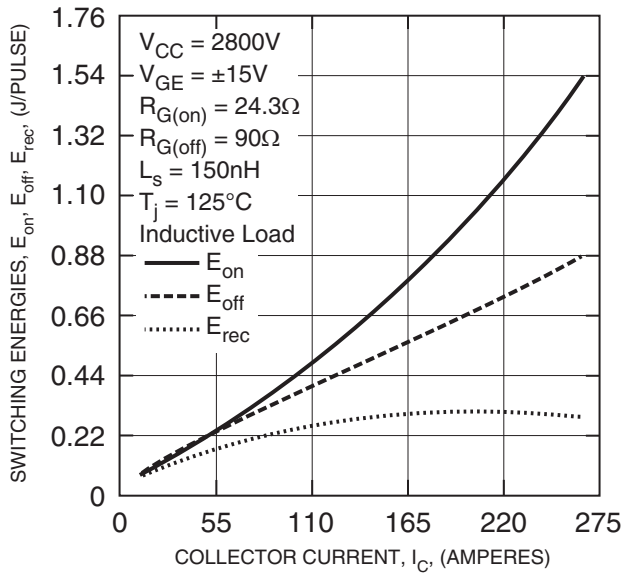

HALF-BRIDGE SWITCHING ENERGY CHARACTERISTICS (TYPICAL)

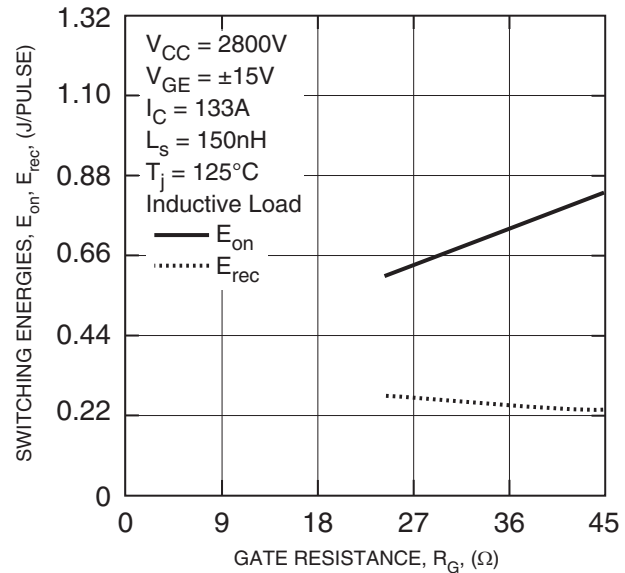

QID4515004
Dual IGBT HVIGBT Module
 150 Amperes/4500 Volts

HALF-BRIDGE SWITCHING ENERGY CHARACTERISTICS (TYPICAL)

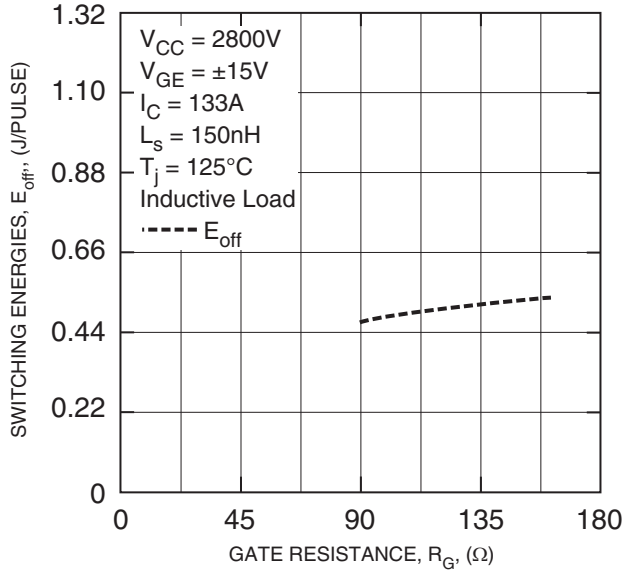

HALF-BRIDGE SWITCHING TIME CHARACTERISTICS (TYPICAL)

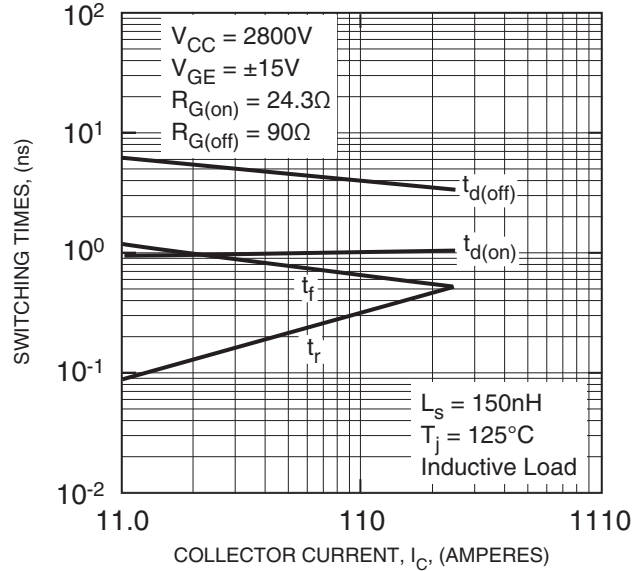

FREE-WHEEL DIODE REVERSE RECOVERY CHARACTERISTICS (TYPICAL)

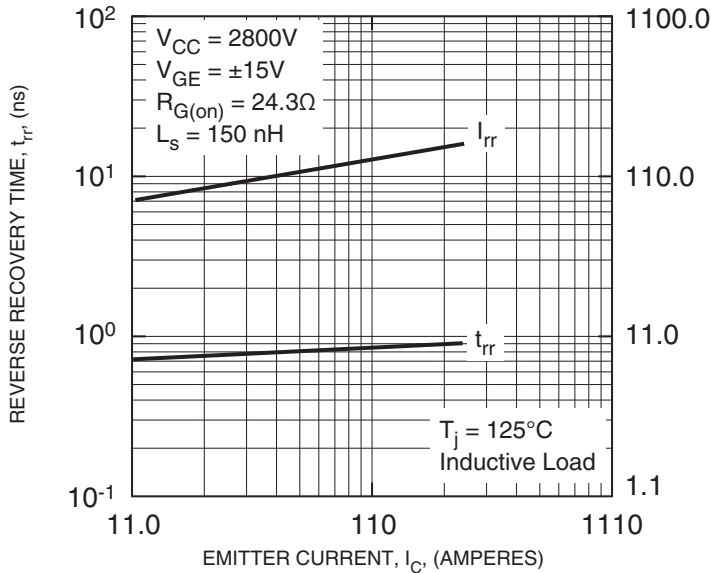

REVERSE BIAS SAFE OPERATING AREA (RBSOA)

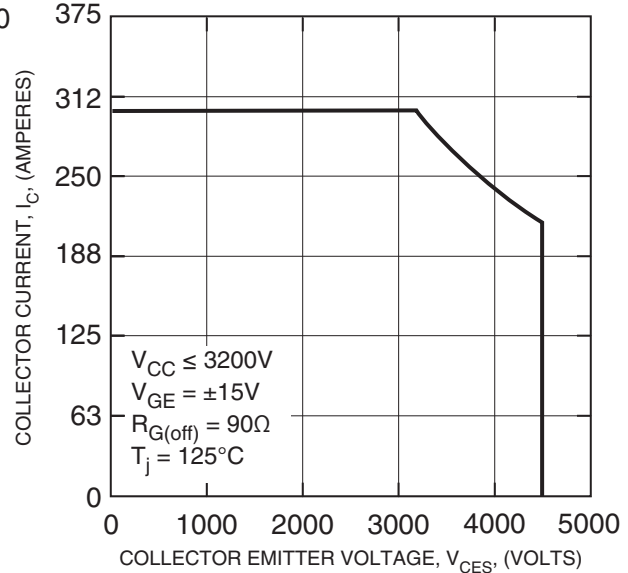

QID4515004
Dual IGBT HVIGBT Module
 150 Amperes/4500 Volts

SHORT CIRCUIT SAFE OPERATING AREA (SCSOA)

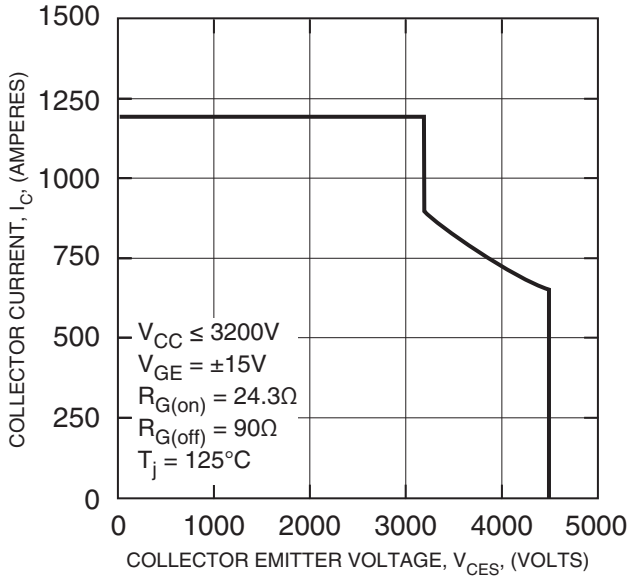

FREE-WHEEL DIODE REVERSE RECOVERY SAFE OPERATING AREA (RRSOA)

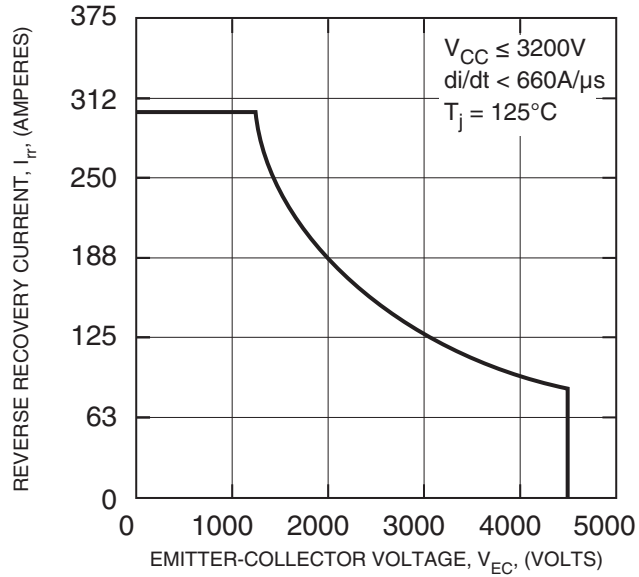

TRANSIENT THERMAL IMPEDANCE CHARACTERISTICS (IGBT & FWDi)

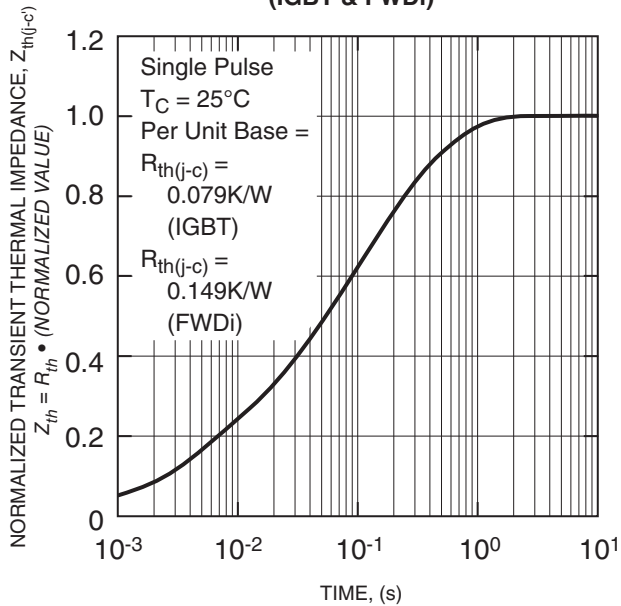

Information presented is based upon manufacturers testing and projected capabilities. This information is subject to change without notice. The manufacturer makes no claim as to the suitability of use, reliability, capability, or future availability of this product.