

Rubber stem helps to achieve travel of 0.3 to 0.55mm & over travel

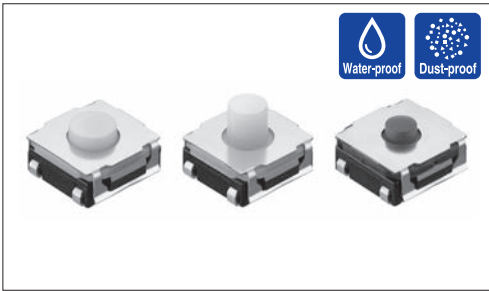

■ Typical Specifications



Items	Specifications
Rating (max.)	50mA 12V DC
Rating (min.)	10 μ A 1V DC
Initial contact resistance	100m Ω max.
Protective structure ※	IP67 equivalent (Except SKRAAW)

■ Product Line

Product No.	Operating force	Operating direction	Travel (mm)	Operating life (5mA 5V DC)	Stem color	Minimum order unit (pcs.)	
						Japan	Export
SKRAAWE010	0.6N	Top push	0.3	4,000,000 cycles	Blue	3,000	3,000
SKRAAKE010	2.45N				White		
SKRAALE010	3.92N		100,000 cycles	0.35	Blue	1,400	1,400
SKRAAME010	1.96N			0.5			
SKRAAQE010	3.43N			0.55			

■ Packing Specifications

Taping

Series	Number of packages (pcs.)			Reel width W (mm)	Tape width (mm)	Export package measurements (mm)
	1 reel	1 case /Japan	1 case /export packing			
SKRAAK SKRAAL SKRAAW	3,000	30,000	30,000	13.5	12	401×401×214
SKRAAM SKRAAQ	1,400	11,200	11,200	17.5	16	

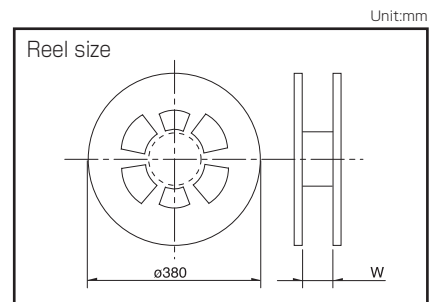

Note

For reels of 330mm diameter, please inquire.

■ Dimensions

Style	PC board land dimensions (Viewed from switch mounting face)												
<table border="1"> <thead> <tr> <th></th> <th>h</th> <th>A</th> </tr> </thead> <tbody> <tr> <td>SKRAAW</td> <td>3.4</td> <td>2.0</td> </tr> <tr> <td>SKRAAK · SKRAAL</td> <td>3.4</td> <td>2.9</td> </tr> <tr> <td>SKRAAM · SKRAAQ</td> <td>5.1</td> <td>2.5</td> </tr> </tbody> </table>		h	A	SKRAAW	3.4	2.0	SKRAAK · SKRAAL	3.4	2.9	SKRAAM · SKRAAQ	5.1	2.5	
	h	A											
SKRAAW	3.4	2.0											
SKRAAK · SKRAAL	3.4	2.9											
SKRAAM · SKRAAQ	5.1	2.5											

■ Circuit Diagram

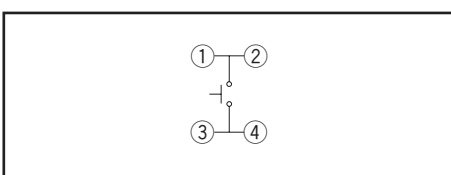

※ Assumes the switch is left alone without being operated. Under the specified conditions, dust and water ingress with a significant impact on the switch's on-off function is prevented.
IP67 dust and water resistance is guaranteed for the switch alone and performance may not be guaranteed depending on the mounting conditions and usage.

Refer to P.259 for soldering conditions.

TACT Switch™

List of Varieties

TACT Switch™

















Sharp Feeling

Soft Feeling

Snap-In Type

Surface Mount Type

Radial Type

Type		Sharp Feeling Type							
		Surface Mount							
Series		SKTH	SKRP	SKQM	SKQY	SKSU	SKST	SKRA	SKHM
Photo									
Features		Compact size	High operation force Compact size	Compact size		Middle travel			—
Water-proof		—	—	—	—	●	—	○	—
Dust-proof		●	—	—	—	●	—	○	—
IP standard		—	—	—	—	67 equivalency	—	67 equivalency	—
Operating direction	Top push	●	●	●	●	●	●	●	●
	Side push	—	—	—	—	—	—	—	—
Dimensions (mm)	W	3.5	4.2	6	6.1	5.3	8.5	□6.2	6.2
	D	3.2	3.2	3.5	3.7	5.4	8.5		6.5
	H	1.8/2.5	2.5	4.3/5	2.5	3.85	3.95	3.5/5.2	3.1
Operation force coverage	to 1N	↕	↕	↕	↕	↕	↕	↕	↕
	1N to 2N								
	2N to 3N								
	3N to 4N								
4N to 5N	↕	↕	↕	↕	↕	↕	↕	↕	
Travel (mm)		0.12	0.2	0.25		0.7	0.9	See the relevant pages for respective product descriptions	0.25
Ground terminal		—	—	—	○	—	—	—	●
Operating temperature range		-40°C to +90°C							-40°C to +85°C
Automotive use		●	●	●	●	●	●	○	—
Life Cycle									
Electrical performance	Rating (max.) (Resistive load)	25mA 16V DC	50mA 16V DC	50mA 12V DC		50mA 16V DC		50mA 12V DC	
	Rating (min.) (Resistive load)	10μA 1V DC							
	Insulation resistance	100MΩ min. 100V DC 1min.							
	Voltage proof	100V AC 1min.	250V AC 1min.						
Durability	Vibration	0 to 55 to 10Hz/min., the amplitude is 1.5mm for all the frequencies, in the 3 direction of X, Y and Z for 2 hours respectively							
	Lifetime	Shall be in accordance with individual specifications.							
Environmental performance	Cold	-40°C 96h	-40°C 1,000h	-40°C 96h		-40°C 1,000h		-40°C 96h	
	Dry heat	90°C 96h	90°C 1,000h	90°C 96h		90°C 1,000h		90°C 96h	
	Damp heat	60°C, 90 to 95%RH 96h	60°C, 90 to 95%RH 1,000h	60°C, 90 to 95%RH 96h		60°C, 90 to 95%RH 1,000h		60°C, 90 to 95%RH 96h	
Page		227	229	230	231	233	234	235	236

W : Width. The most outer dimension excluding terminal portion.
D : Depth. The most outer dimension excluding terminal portion.
H : Height. The minimum dimension if there are variances.

TACT Switch™ Soldering Conditions 259
TACT Switch™ Cautions 260

Notes

- The automotive operating temperature range to be individually discussed upon request.
- Indicates applicability to all products in the series, while ○ indicates applicability to some products in the series.

Condition for Reflow

Available for Surface Mount Type.

1. Temperature measurement: Thermocouple ϕ 0.1 to 0.2 CA (K) or CC (T) at solder joints (copper foil surface).
A heat resistive tape should be used to fix thermocouple.
2. Temperature profile

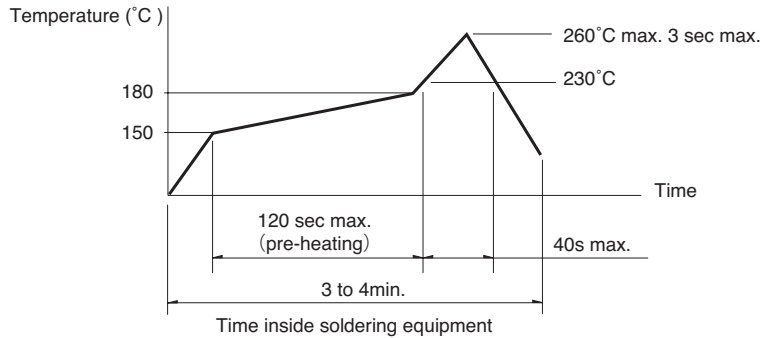

Notes

1. The above temperature shall be measured of the top of switch. There are cases where the PC board's temperature greatly differs from that of the switch, depending on the material, size, thickness of PC boards and others.
The above-stated conditions shall also apply to switch surface temperatures.
2. Soldering conditions differ depending on reflow soldering machines.
Prior verification of soldering condition is highly recommended.

Conditions for Auto-dip

Available for Snap-in Type and Radial Type.

Items	Condition
Flux built-up	Mounting surface should not be exposed to flux
Preheating temperature	Ambient temperature of the soldered surface of PC board. 100°C max.
Preheating time	60s max.
Soldering temperature	260°C max.
Duration of immersion	5s max.
Number of soldering	2times max.

SKHH, SKPD Series

Items	Condition
Flux built-up	Mounting surface should not be exposed to flux
Preheating temperature	Ambient temperature of the soldered surface of PC board. 110°C max.
Preheating time	60s max.
Soldering temperature	260°C max.
Duration of immersion	5s max.
Number of soldering	2times max.

SKQJ, SKQK, SKEG Series

Items	Condition
Flux built-up	Mounting surface should not be exposed to flux
Preheating temperature	Ambient temperature of the soldered surface of PC board. 100°C max.
Preheating time	45s max.
Soldering temperature	255°C max.
Duration of immersion	5s max.
Number of soldering	2times max.

Manual Soldering

Items	Condition
Soldering temperature	350°C max.
Duration of soldering	3s max.
Capacity of soldering iron	60W max.

SKHH, SKHW, SKRG, SKPD Series

Items	Condition
Soldering temperature	360°C max.
Duration of soldering	3s max.
Capacity of soldering iron	60W max.

SKTD, SKTG, SKQJ, SKQK, SKEG Series

Items	Condition
Soldering temperature	350°C max.
Duration of soldering	3s max.
Capacity of soldering iron	20W max.

Notes

1. Prevent flux penetration from the top side of the TACT Switch™.
2. Switch terminals and a PC board should not be coated with flux prior to soldering.
3. The second soldering should be done after the switch is stable with normal temperature.
4. Use the flux with a specific gravity of min 0.81.
(EC-19S-8 by TAMURA Corporation, or equivalents.)