

PowerSO-10™
TURBOSWITCH™ "B" ULTRA-FAST HIGH VOLTAGE DIODE
MAIN PRODUCT CHARACTERISTICS

$I_{F(AV)}$	12A
V_{RRM}	600V
t_{rr} (typ)	50ns
V_F (max)	1.3V

FEATURES AND BENEFITS

- SPECIFIC TO THE FOLLOWING OPERATIONS: Snubbing or clamping, demagnetization and rectification.
- ULTRA-FAST, VERY SOFT AND NOISE-FREE RECOVERY.
- VERY LOW OVERALL POWER LOSSES AND PARTICULARLY LOW FORWARD VOLTAGE.
- DESIGNED FOR HIGH PULSED CURRENT OPERATIONS.
- HIGH FREQUENCY OPERATIONS
- HIGH DISSIPATION MINIATURE PACKAGE
- SURFACE MOUNT TECHNOLOGY COMPATIBLE

DESCRIPTION

The TURBOSWITCH is a very high performance series of ultra-fast high voltage power diodes from 600V to 1200V.

TURBOSWITCH, B family, drastically cuts losses in all high voltage operations which require extremely fast, soft and noise-free power diodes. They are particularly suitable in the primary circuit

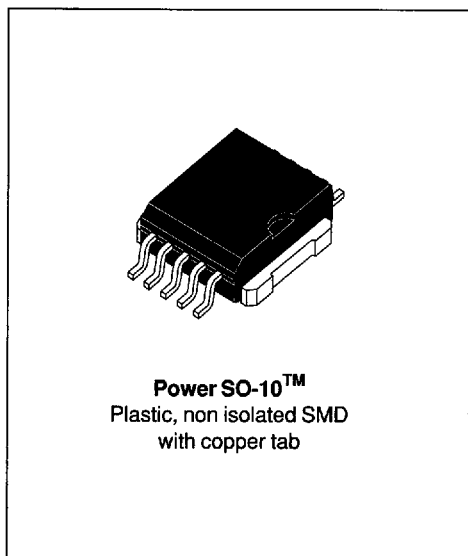

of an SMPS as snubber, clamping or demagnetizing diodes, and also in most power converters as high performance rectifier diodes. Packaged in PSO-10, this 600V devices are particularly intended for use on 240V domestic mains.

ABSOLUTE MAXIMUM RATINGS

Symbol	Parameter	Value	Unit
V_{RRM}	Repetitive peak reverse voltage	600	V
V_{RSM}	Non repetitive peak reverse voltage	600	V
$I_{F(RMS)}$	RMS forward current (All pins connected)	27	A
I_{FRM}	Repetitive peak forward current ($t_p = 5 \mu s$, $f = 1 kHz$)	320	A
T_j	Max operating junction temperature	- 65 to + 150	°C
T_{stg}	Storage temperature	- 65 to + 150	°C

TM : PowerSO-10 and TURBOSWITCH are trademarks of SGS-THOMSON Microelectronics.

THERMAL AND POWER DATA

Symbol	Parameter	Conditions	Value	Unit
$R_{th(j-c)}$	Junction to case thermal resistance		1.9	$^{\circ}\text{C/W}$
P_1	Conduction power dissipation (see fig. 5)	$I_{F(AV)} = 12\text{A}$ $\delta = 0.5$ $T_c = 114^{\circ}\text{C}$	19	W
P_{max}	Total power dissipation $P_{max} = P_1 + P_3$ ($P_3 = 10\% P_1$)	$T_c = 104^{\circ}\text{C}$	24	W

STATIC ELECTRICAL CHARACTERISTICS (see Fig.5)

Symbol	Parameter	Test Conditions	Min	Typ	Max	Unit
V_F *	Forward voltage drop	$I_F = 12\text{A}$ $T_j = 25^{\circ}\text{C}$			1.4	V
			$T_j = 125^{\circ}\text{C}$			
I_R **	Reverse leakage current	$V_R = 0.8$ $\times V_{RRM}$	$T_j = 25^{\circ}\text{C}$		100	μA
			$T_j = 125^{\circ}\text{C}$		2.0	mA

Test pulses widths : * $t_p = 380 \mu\text{s}$, duty cycle $< 2\%$

** $t_p = 5 \text{ms}$, duty cycle $< 2\%$

DYNAMIC ELECTRICAL CHARACTERISTICS

TURN-OFF SWITCHING (see Fig.6)

Symbol	Parameter	Test Conditions	Min	Typ	Max	Unit
t_{rr}	Reverse recovery time	$T_j = 25^{\circ}\text{C}$ $I_F = 0.5 \text{A}$ $I_R = 1\text{A}$ $I_{rr} = 0.25\text{A}$ $I_F = 1 \text{A}$ $dI_F/dt = -50\text{A}/\mu\text{s}$ $V_R = 30\text{V}$		50	100	ns
I_{RM}	Maximum reverse recovery current	$T_j = 125^{\circ}\text{C}$ $V_R = 400\text{V}$ $I_F = 12\text{A}$ $dI_F/dt = -96 \text{A}/\mu\text{s}$ $dI_F/dt = -500 \text{A}/\mu\text{s}$		30	18	A
S factor	Softness factor	$T_j = 125^{\circ}\text{C}$ $V_R = 400\text{V}$ $I_F = 12\text{A}$ $dI_F/dt = -500 \text{A}/\mu\text{s}$		0.9		/

TURN-ON SWITCHING (see Fig.7)

Symbol	Parameter	Test Conditions	Min	Typ	Max	Unit
t_{fr}	Forward recovery time	$T_j = 25^{\circ}\text{C}$ $I_F = 12\text{A}$, $dI_F/dt = 96 \text{A}/\mu\text{s}$ measured at, $1.1 \times V_{Fmax}$			500	ns
V_{Fp}	Peak forward voltage	$T_j = 25^{\circ}\text{C}$ $I_F = 12\text{A}$, $dI_F/dt = 96 \text{A}/\mu\text{s}$			8	V

PIN OUT configuration in PowerSO-10 :

Anode = pin 1 to 5

Cathode = connected to base tab

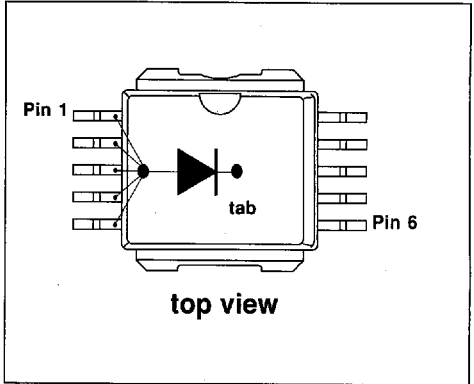

APPLICATION DATA

The TURBOSWITCH "B" is especially designed to provide the lowest overall power losses in any application such as snubbing, clamping, demagne-

tization and rectification. In such applications (fig.1 to fig.4), the way of calculating the power losses is given below :

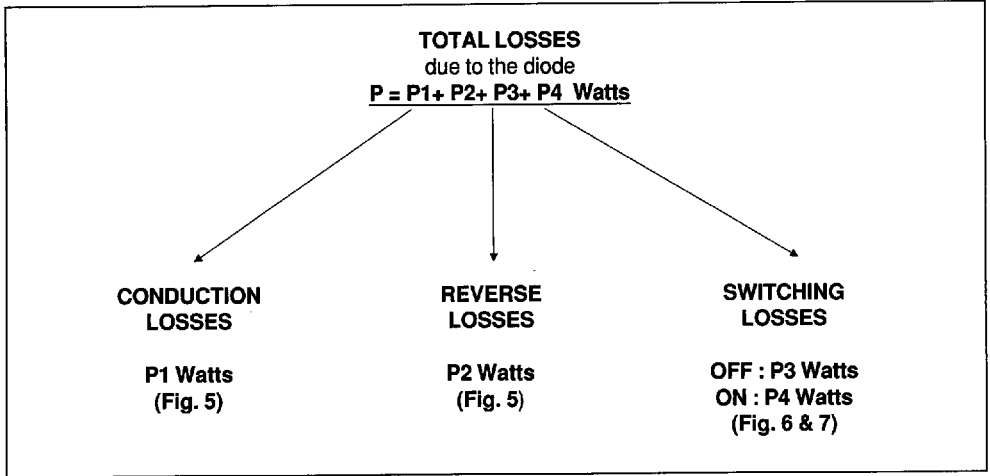

Fig. 1 : SNUBBER DIODE.

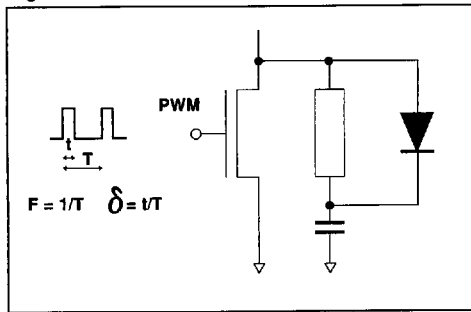

Fig. 2 : CLAMPING DIODE.

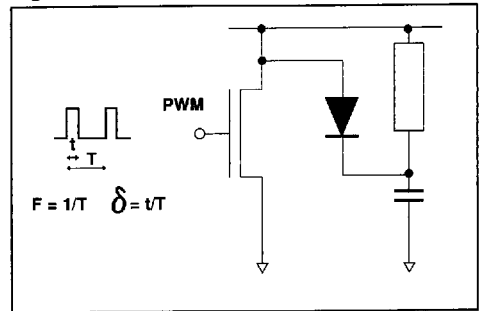

Fig. 3 : DEMAGNETIZING DIODE.

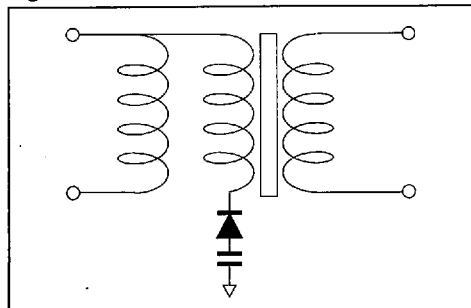
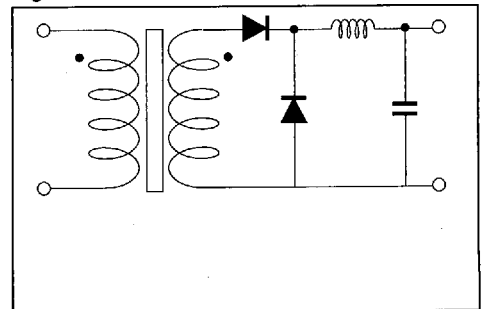
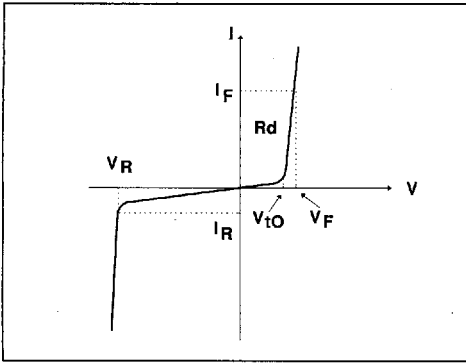

Fig. 4 : RECTIFIER DIODE.



APPLICATION DATA (Cont'd)

Fig. 5: STATIC CHARACTERISTICS



Conduction losses :

$$P1 = V_{t0} \cdot I_{F(AV)} + R_d \cdot I_{F(RMS)}^2$$

with

$$V_{t0} = 1.00 \text{ V}$$

$$R_d = 0.025 \text{ Ohm}$$

(Max values at 125°C)

Reverse losses :

$$P2 = V_R \cdot I_R \cdot (1 - \delta)$$

Fig. 6: TURN-OFF CHARACTERISTICS

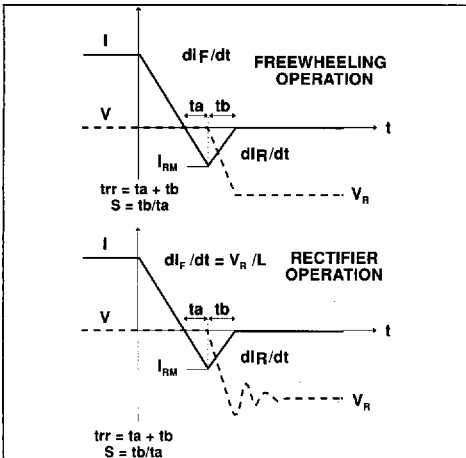

Turn-off losses :

$$P3 = \frac{V_R \times I_{RM}^2 \times S \times F}{6 \times di/dt}$$

Turn-off losses :

(with non negligible serial inductance)

$$P3' = \frac{V_R \times I_{RM}^2 \times S \times F}{6 \times di/dt} + \frac{L \times I_{RM}^2 \times F}{2}$$

P3 and P3' are suitable for power MOSFET and IGBT

Fig. 7: TURN-ON CHARACTERISTICS

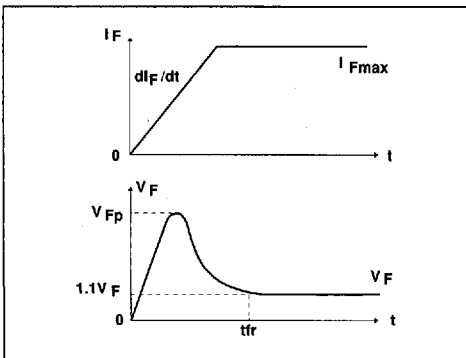

Turn-on losses :

$$P4 = 0.4 (V_{FP} - V_F) \cdot I_{Fmax} \cdot t_{tr} \cdot F$$

Fig 8 : Conduction losses versus average current

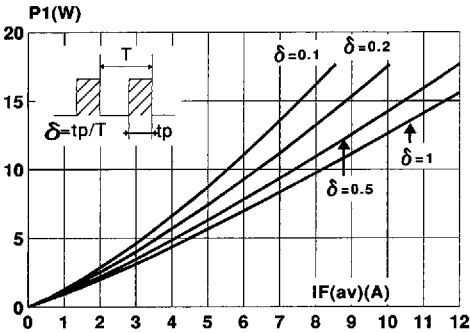

Fig 9 : Switching OFF losses versus dIF/dt

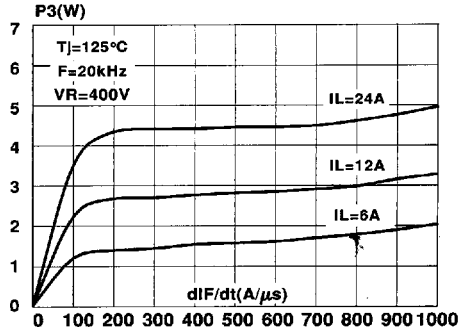

Fig 10 : Switching ON losses versus dIF/dt

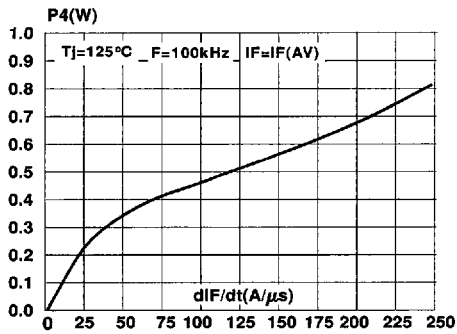

Fig 11 : Forward voltage drop versus forward current

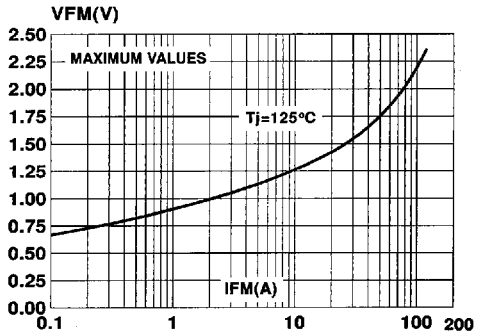

Fig 12 : Relative variation of thermal transient impedance junction to case versus pulse duration

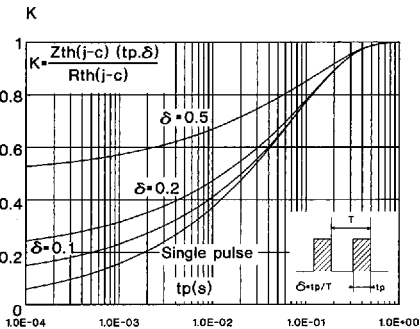

Fig 13 : Peak reverse recovery current versus dI_F/dt

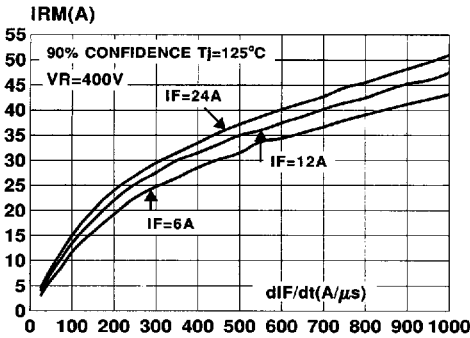

Fig 14 : Reverse recovery time versus dI_F/dt

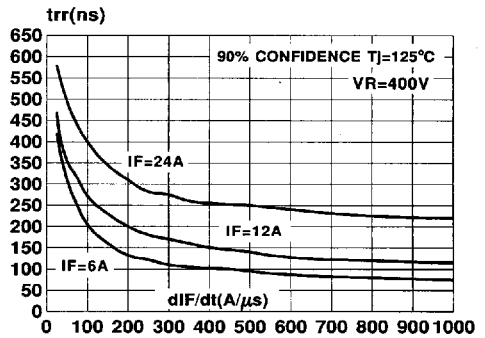

Fig 15 : Softness factor (t_b/t_a) versus dI_F/dt

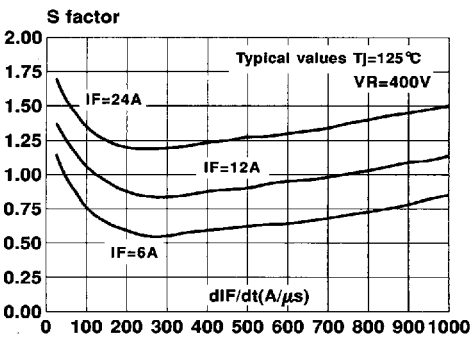

Fig 16 : Relative variation of dynamic parameters versus junction temperature (Reference $T_j=125^\circ C$)

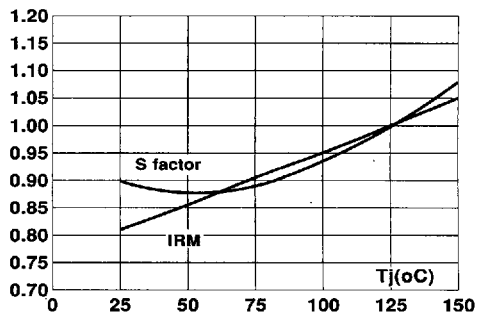

Fig 17 : Transient peak forward voltage versus dI_F/dt

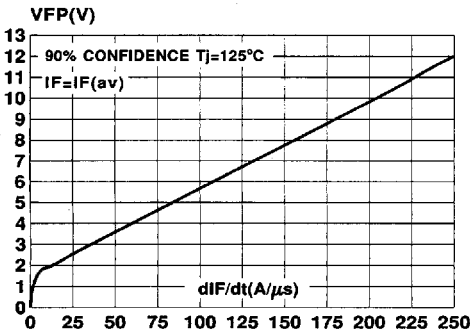

Fig 18 : Forward recovery time versus dI_F/dt

