

## FMXS-2206S

Aug, 2011

Fast Recovery Diode

### General Description

This product is FRD that has excellent high speed performance.

It achieved a balance between high speed at high temperature operates and low-VF.

### Applications

- An DC-DC converters.
- A high current secondary rectifier.
- A high frequencies rectifier circuit, etc.

### Features

- An ultrafast recovery diode.
- A balance low-VF and high speed performance at high temperature.
- A great isolation performance due to full mold package.

### Package

FM20 (TO-220 Full Mold)

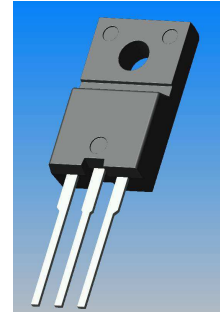

### Key Specifications

Item	Unit	Rating	Conditions
$V_{RM}$	V	600	
$V_F$	V	1.5	$I_F=10A$
$I_{F(AV)}$	A	20	
$t_{rr}$	ns	30	

### Typical Characteristics

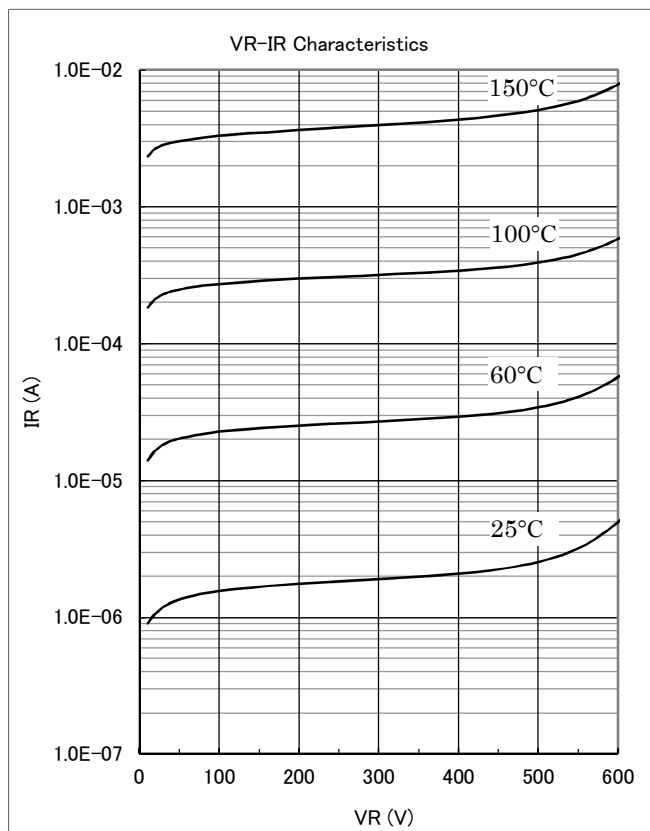
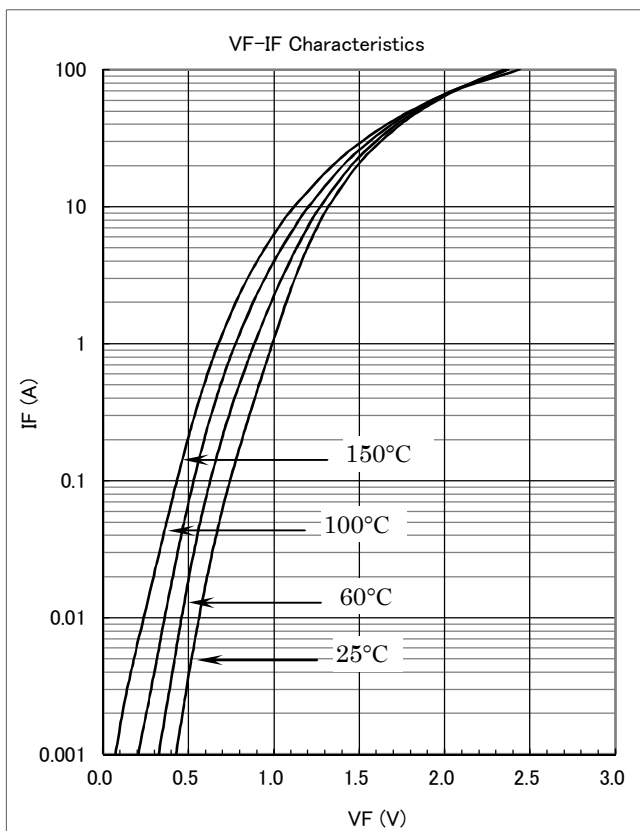

VF-IF&VR-IR show ratings per one chip.

The information included herein is believed to be accurate and reliable. However, SANKEN ELECTRIC CO., LTD assumes no responsibility for its use ; nor for any infringements of patents or other rights of third parties that may result from its use.

# FMXS-2206S

Aug, 2011

Fast Recovery Diode

### ★ Absolute maximum ratings

No.	Item	Symbol	Unit	Rating	Conditions
1	Transient Peak Reverse Voltage	$V_{RSM}$	V	600	
2	Peak Reverse Voltage	$V_{RM}$	V	600	
3	Average Forward Current	$I_{F(AV)}$	A	20	
4	Peak Surge Forward Current	$I_{FSM}$	A	100	10msec. Half sinewave, one shot
5	$I^2t$ Limiting Value	$I^2t$	$A^2s$	50	$1msec \leq t \leq 10msec$
6	Junction Temperature	$T_j$	$^{\circ}C$	-40~ +150	
7	Storage Temperature	$T_{stg}$	$^{\circ}C$	-40~ +150	

No.1,2,4&amp;5 show ratings per one chip.

### ★ Electrical characteristics (Ta=25°C, unless otherwise specified)

No.	Item	Symbol	Unit	Value	Conditions
1	Forward Voltage Drop	$V_F$	V	1.5 max.	$I_F=10A$
2	Reverse Leakage Current	$I_R$	$\mu A$	50 max.	$V_R=V_{RM}$
3	Reverse Leakage Current Under High Temperature	$H-I_R$	mA	30 max.	$V_R=V_{RM}, T_j=150^{\circ}C$
4	Reverse Recovery Time	trr1	ns	30 max.	$I_F=I_{RP}=500mA,$ $T_j=25^{\circ}C, 90\%$ Recovery point
		trr2	ns	25 max.	$I_F=500mA, I_{RP}=1A,$ 75% Recovery point, $T_j=25^{\circ}C$
5	Thermal Resistance	$R_{th(j-l)}$	$^{\circ}C/W$	4 max.	Between Junction and case

No.1,2,3&amp;4 show characteristics per one chip.

The information included herein is believed to be accurate and reliable. However, SANKEN ELECTRIC CO., LTD assumes no responsibility for its use ; nor for any infringements of patents or other rights of third parties that may result from its use.

FMXS-2206S

Aug, 2011

Fast Recovery Diode

★ Characteristics

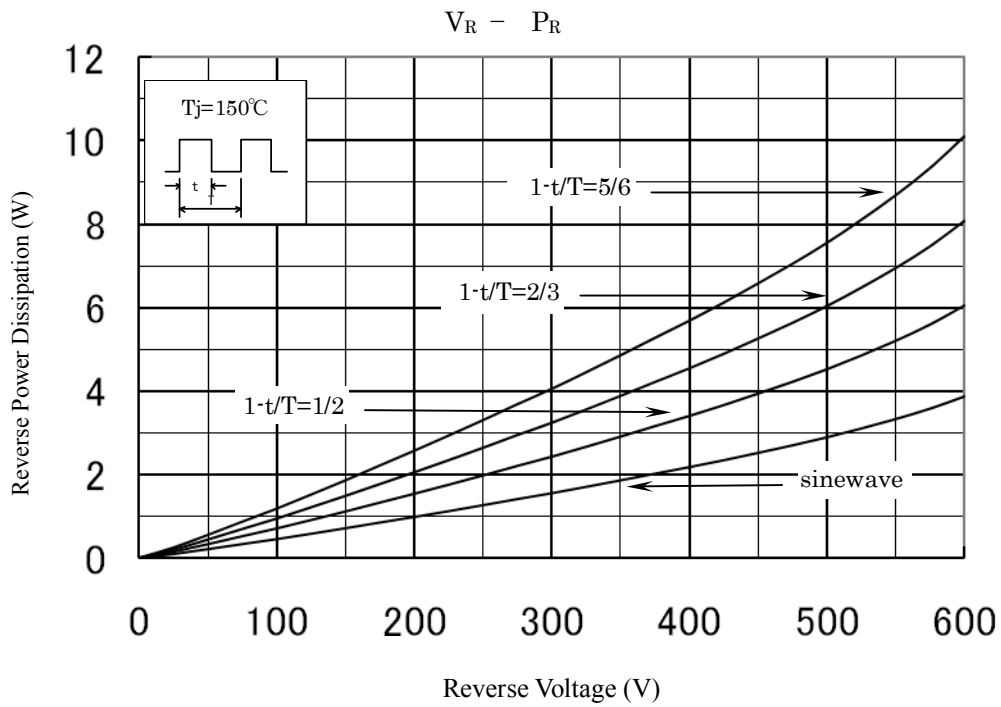
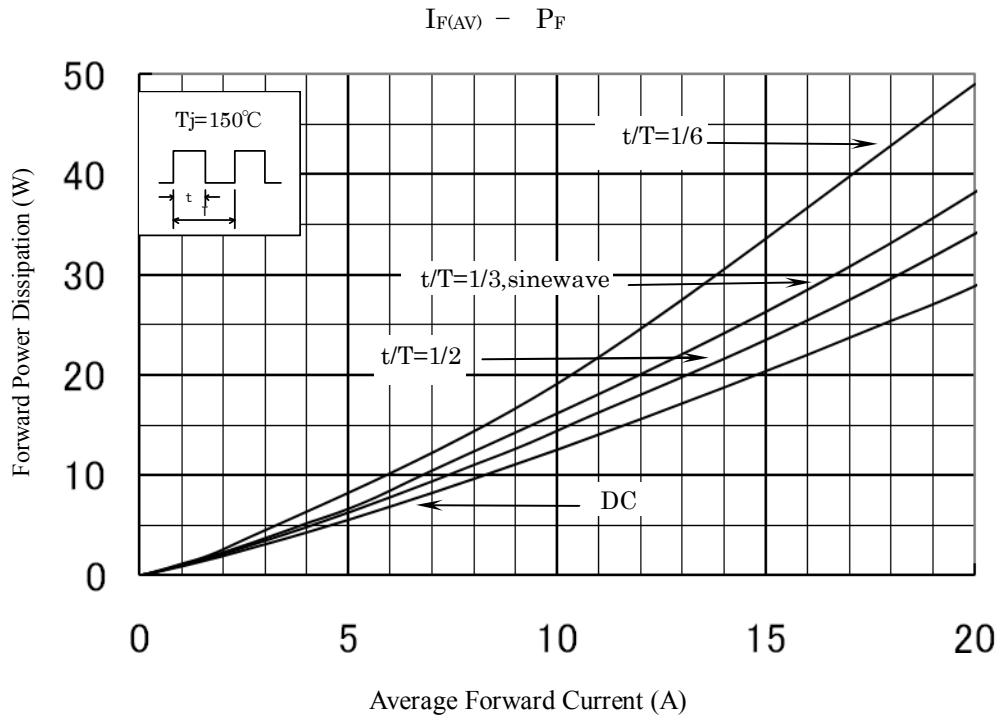

The information included herein is believed to be accurate and reliable. However, SANKEN ELECTRIC CO., LTD assumes no responsibility for its use ; nor for any infringements of patents or other rights of third parties that may result from its use.

FMXS-2206S

Aug, 2011

Fast Recovery Diode

★ Derating

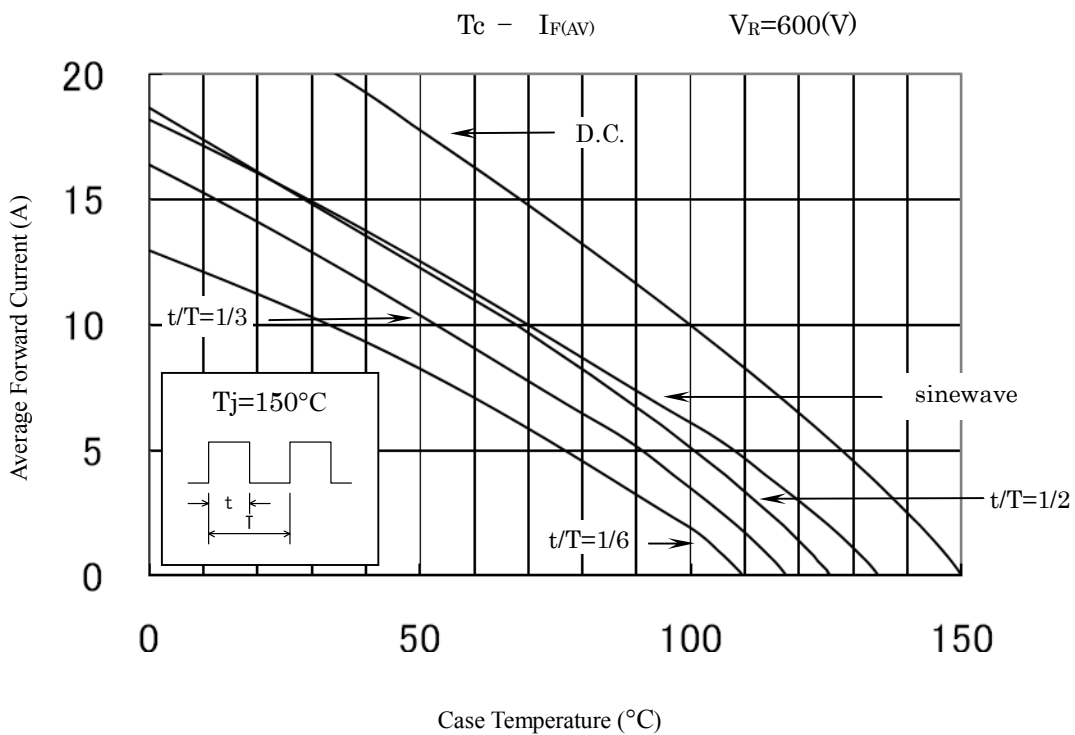
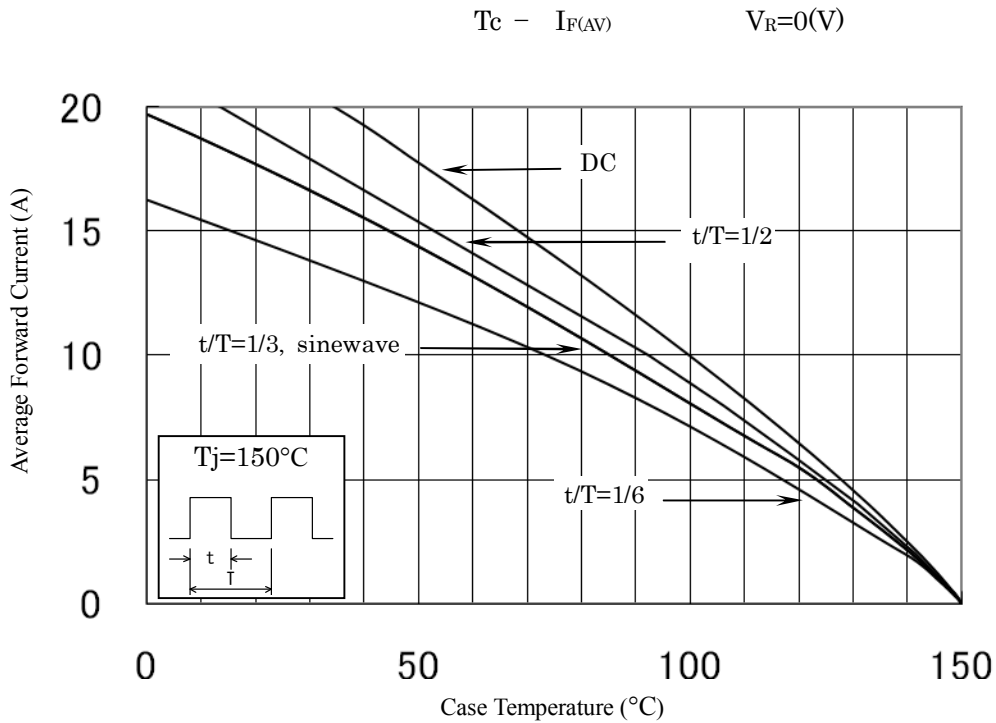

The information included herein is believed to be accurate and reliable. However, SANKEN ELECTRIC CO., LTD assumes no responsibility for its use ; nor for any infringements of patents or other rights of third parties that may result from its use.

FMXS-2206S

Aug, 2011

Fast Recovery Diode

★ Package information (mm)

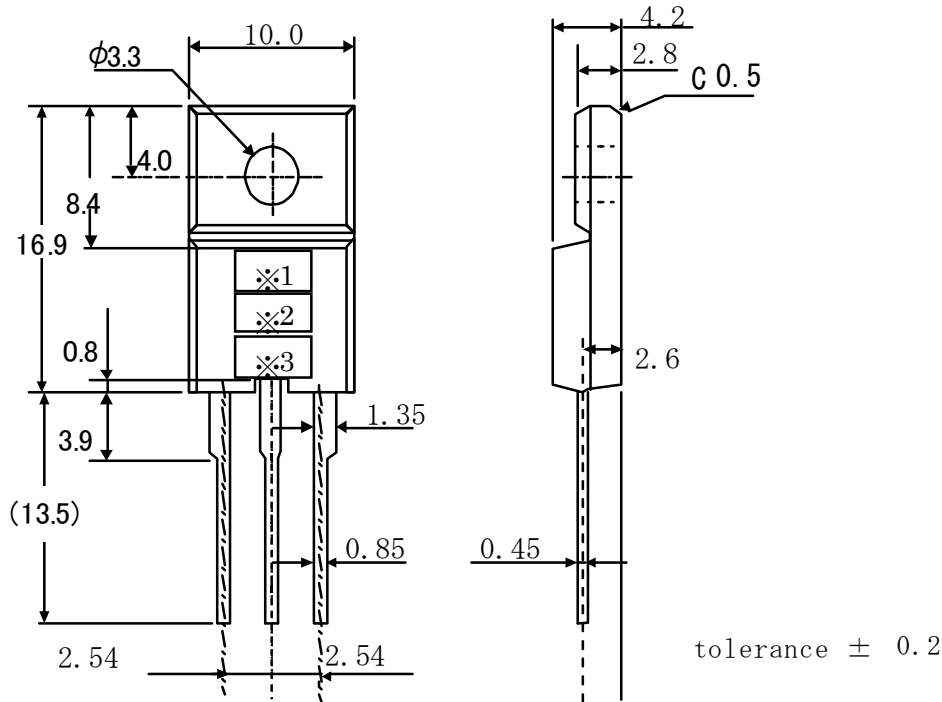

Type Name	Marking		
	※1 Type Name	※2 Polarity	※3 Lot number
FMXS-2206S	XS2206		1st letter: Last digit of year 2nd letter: Month From 1 to 9 for Jan. to Sep., O for Oct., N for Nov., D for Dec. 3rd & 4th letter: Day ex. 0004 (Oct. 4, 2010)

The information included herein is believed to be accurate and reliable. However, SANKEN ELECTRIC CO., LTD assumes no responsibility for its use ; nor for any infringements of patents or other rights of third parties that may result from its use.