

## Thyristor/Diode Modules



**VRRM / VDRM** 800 to 1800V  
**IFAV / ITAV** 110A

### Applications

- Power Converters
- Lighting Control
- DC Motor Control and Drives
- Heat and temperature control

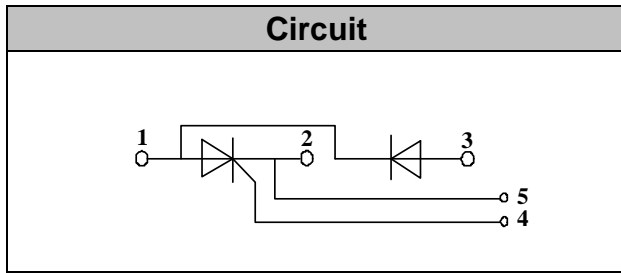

### Features

- International standard package
- High Surge Capability
- Glass passivated chip
- Simple Mounting
- Heat transfer through aluminum oxide DBCceramic isolated metal baseplate
- UL recognized applied for file no. E360040

### Module Type

TYPE	VRRM/VDRM	VRSM
MT110CB08T1	800V	900V
MT110CB12T1	1200V	1300V
MT110CB16T1	1600V	1700V
MT110CB18T1	1800V	1900V

### ◆ Diode

#### Maximum Ratings

Symbol	Item	Conditions	Values	Units
ID	Output Current(D.C.)	Tc=85°C	110	A
IFSM	Surge forward current	t=10mS Tvj =45°C	2250	A
i <sup>2</sup> t	Circuit Fusing Consideration		25000	A <sup>2</sup> s
Visol	Isolation Breakdown Voltage(R.M.S)	a.c.50HZ;r.m.s.;1min	3000	V
Tvj	Operating Junction Temperature		-40 to +125	°C
Tstg	Storage Temperature		-40 to +125	°C
Mt	Mounting Torque	To terminals(M5)	3±15%	Nm
Ms		To heatsink(M6)	5±15%	Nm
Weight	Module (Approximately)		100	g

#### Thermal Characteristics

Symbol	Item	Conditions	Values	Units
Rth(j-c)	Thermal Impedance, max.	Junction to Case	0.14	°C/W
Rth(c-s)	Thermal Impedance, max.	Case to Heatsink	0.10	°C/W

#### Electrical Characteristics

Symbol	Item	Conditions	Values			Units
			Min.	Typ.	Max.	
VFM	Forward Voltage Drop, max.	T=25°C IF =300A			1.65	V
IRRM	Repetitive Peak Reverse Current, max.	Tvj =25°C VRD=VRRM	≤0.5			mA
		Tvj =125°C VRD=VRRM	≤6			mA



## ◆Thyristor

### Maximum Ratings

Symbol	Item	Conditions	Values	Units
$I_{TAV}$	Average On-State Current	Sine 180°; $T_c=85^\circ\text{C}$	110	A
$I_{TSM}$	Surge On-State Current	$T_{VJ}=45^\circ\text{C}$ $t=10\text{ms}$ , sine $T_{VJ}=125^\circ\text{C}$ $t=10\text{ms}$ , sine	2250 1900	A
$i^2t$	Circuit Fusing Consideration	$T_{VJ}=45^\circ\text{C}$ $t=10\text{ms}$ , sine $T_{VJ}=125^\circ\text{C}$ $t=10\text{ms}$ , sine	25000 18000	A <sup>2</sup> s
Visol	Isolation Breakdown Voltage(R.M.S)	a.c.50HZ;r.m.s.;1min	3000	V
$T_{vj}$	Operating Junction Temperature		-40 to +130	°C
$T_{stg}$	Storage Temperature		-40 to +125	°C
$M_t$	Mounting Torque	To terminals(M5)	$3 \pm 15\%$	Nm
$M_s$		To heatsink(M6)	$5 \pm 15\%$	Nm
$di/dt$	Critical Rate of Rise of On-State Current	$T_{VJ}=T_{VJM}$ , $2/3V_{DRM}$ , $I_G=500\text{mA}$ $T_r < 0.5\mu\text{s}$ , $t_p > 6\mu\text{s}$	150	A/ $\mu\text{s}$
$dv/dt$	Critical Rate of Rise of Off-State Voltage, min.	$T_J=T_{VJM}$ , $2/3V_{DRM}$ linear voltage rise	1000	V/ $\mu\text{s}$
a	Maximum allowable acceleration		50	$\text{m/s}^2$

### Thermal Characteristics

Symbol	Item	Conditions	Values	Units
$R_{th(j-c)}$	Thermal Impedance, max.	Junction to Case	0.28	°C/W
$R_{th(c-s)}$	Thermal Impedance, max.	Case to Heatsink	0.20	°C/W

### Electrical Characteristics

Symbol	Item	Conditions	Values			Units
			Min.	Typ.	Max.	
$V_{TM}$	Peak On-State Voltage, max.	$T=25^\circ\text{C}$ $I_T=300\text{A}$			1.65	V
$I_{RRM}/I_{DRM}$	Repetitive Peak Reverse Current, max. / Repetitive Peak Off-State Current, max.	$T_{VJ}=T_{VJM}$ , $V_R=V_{RRM}$ , $V_D=V_{DRM}$			20	mA
$V_{TO}$	On state threshold voltage	For power-loss calculations only ( $T_{VJ}=125^\circ\text{C}$ )			0.9	V
$r_T$	Value of on-state slope resistance. max	$T_{VJ}=T_{VJM}$			2	$\text{m}\Omega$
$V_{GT}$	Gate Trigger Voltage, max.	$T_{VJ}=25^\circ\text{C}$ , $V_D=6\text{V}$			3	V
$I_{GT}$	Gate Trigger Current, max.	$T_{VJ}=25^\circ\text{C}$ , $V_D=6\text{V}$			150	mA
$V_{GD}$	Non-triggering gate voltage, max.	$T_{VJ}=125^\circ\text{C}$ , $V_D=2/3V_{DRM}$			0.25	V
$I_{GD}$	Non-triggering gate current, max.	$T_{VJ}=125^\circ\text{C}$ , $V_D=2/3V_{DRM}$			6	mA
$I_L$	Latching current, max.	$T_{VJ}=25^\circ\text{C}$ , $R_G=33\Omega$		300	600	mA
$I_H$	Holding current, max.	$T_{VJ}=25^\circ\text{C}$ , $V_D=6\text{V}$		150	250	mA
tgd	Gate controlled delay time	$T_{VJ}=25^\circ\text{C}$ , $I_G=1\text{A}$ , $di/dt=1\text{A}/\mu\text{s}$		1		$\mu\text{s}$
tq	Circuit commutated turn-off time	$T_{VJ}=T_{VJM}$		100		$\mu\text{s}$



## Performance Curves

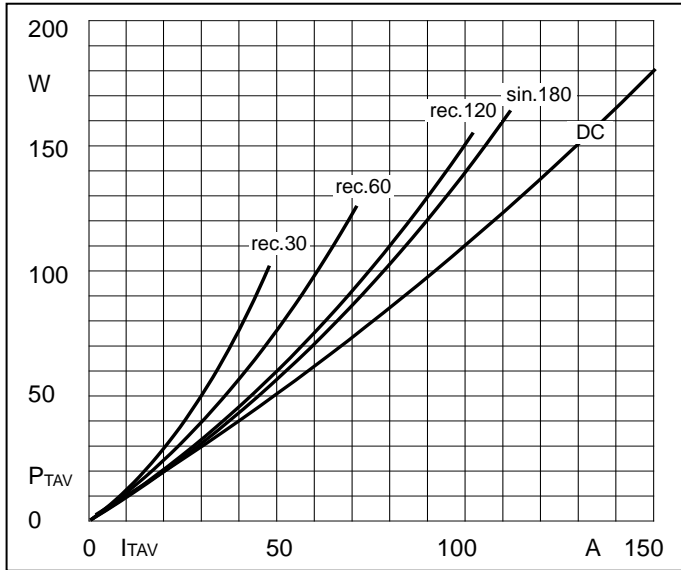

Fig1. Power dissipation

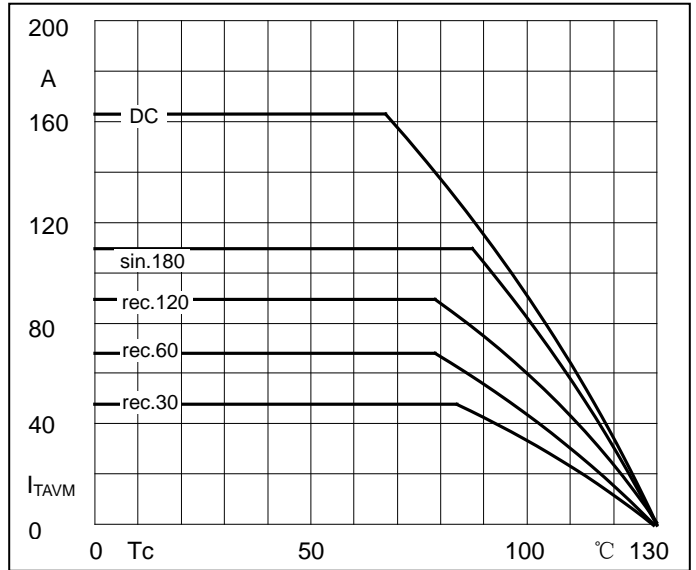

Fig2. Forward Current Derating Curve

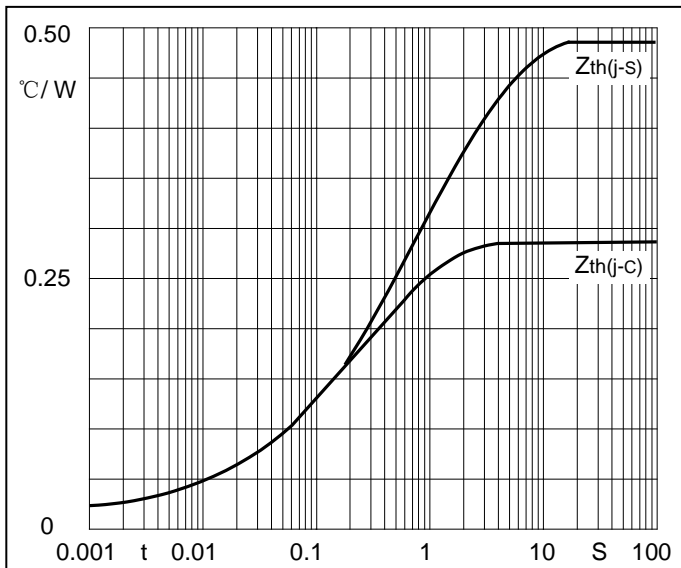

Fig3. Transient thermal impedance

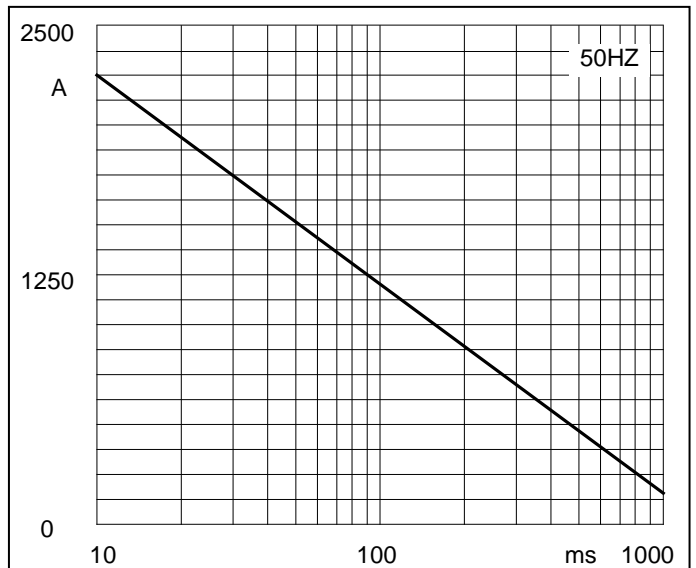

Fig4. Max Non-Repetitive Forward Surge Current

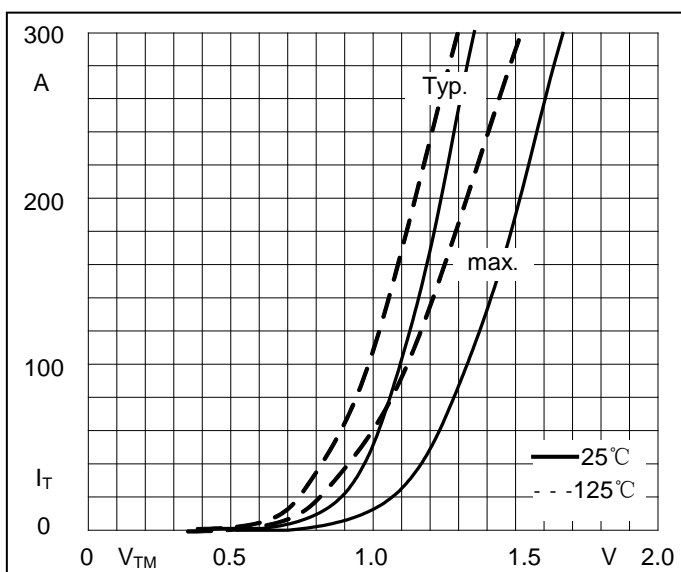
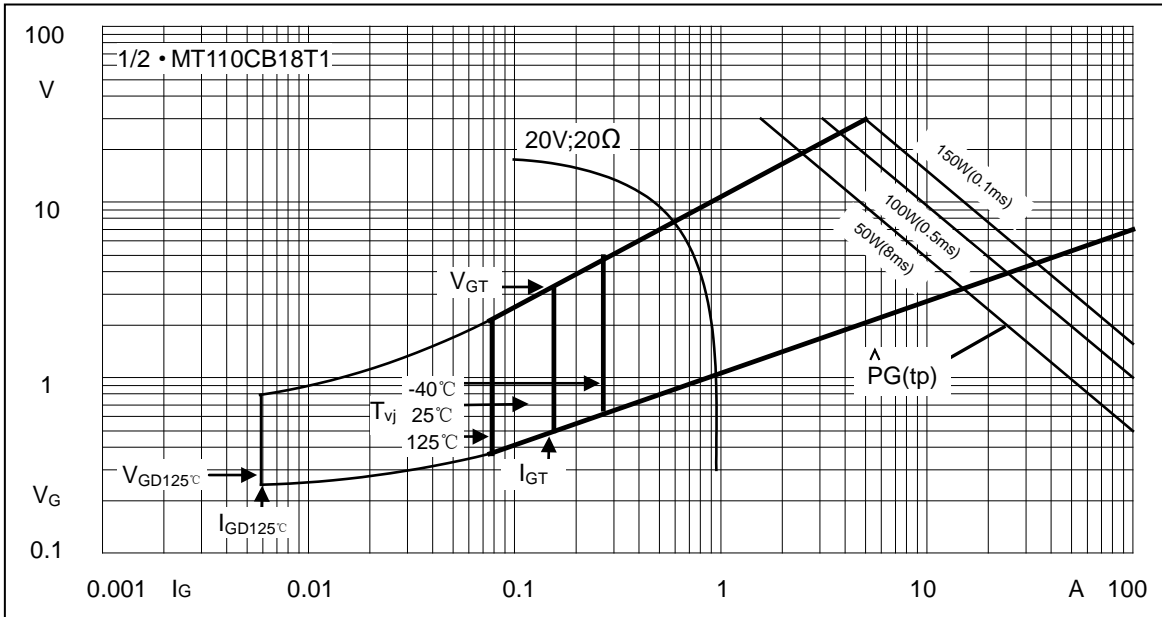

Fig5. Forward Characteristics



**Fig6. Gate trigger Characteristics**

## Package Outline Information

**CASE: T1**

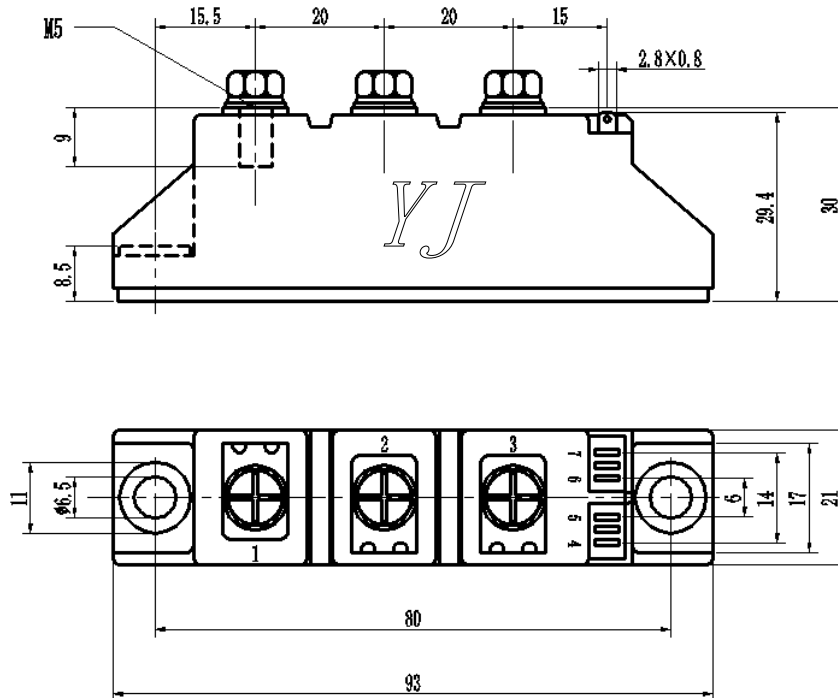

**Dimensions in mm**