



WR-75 Waveguide Gasket kit Square Cover, Choke Flange, Non-Conductive

Waveguide Accessories Technical Data Sheet

PEWGK1004

Description

This is a gasket kit consisting of a non-conductive gasket, stainless steel screws, nuts, and washers to connect two waveguide flanges together. The PEWGK1004 is the kit made expressly for WR-75 Square Cover/Choke waveguide flange. The gasket is made of Shore "A" 70 silicone elastomer. The screws, nuts and washers are made of stainless steel.

Pasternack has waveguide gaskets (both conductive and non-conductive), screws and other accessories that you need for your waveguides. Often people can forget to order items like screws or waveguide supports. Pasternack has a full line of waveguide accessories available for same day shipment so that you do not have to wait for weeks to get your system working.

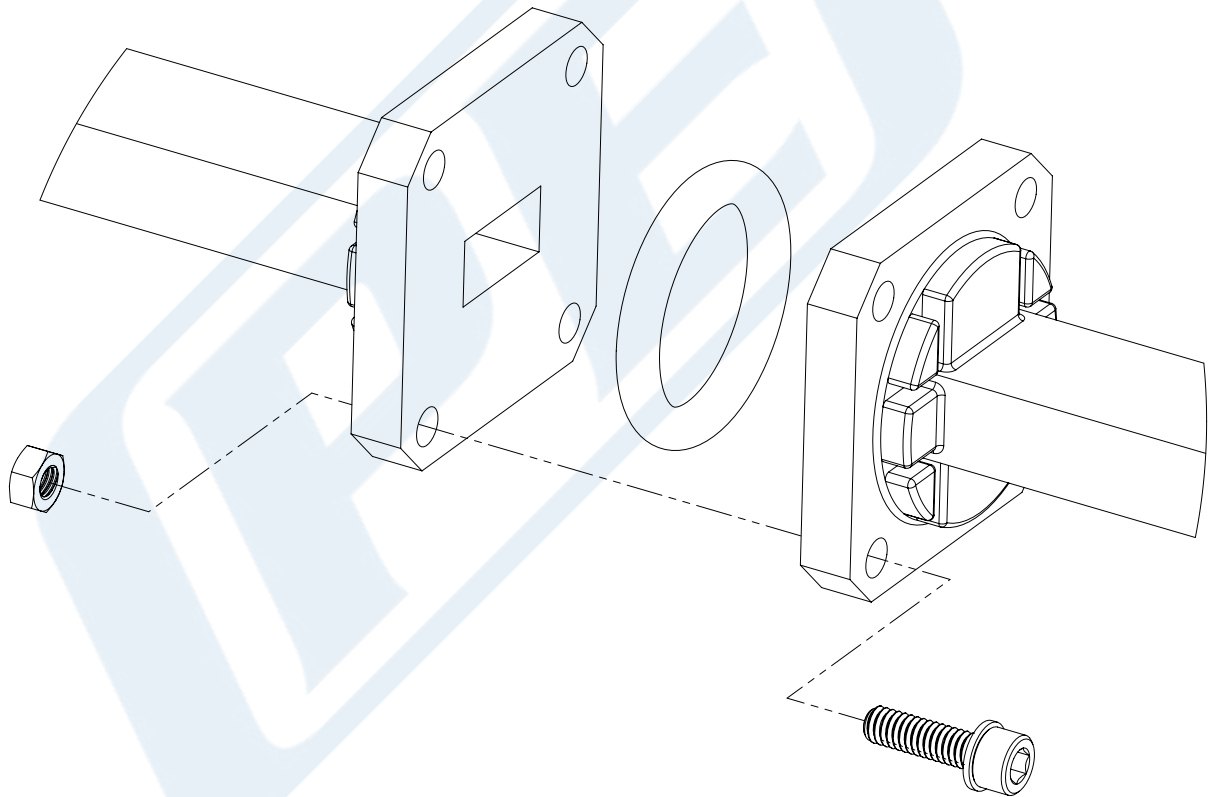

Click the following link (or enter part number in "SEARCH" on website) to obtain additional part information including price, inventory and certifications: [WR-75 Waveguide Gasket kit Square Cover, Choke Flange, Non-Conductive PEWGK1004](#)



WR-75 Waveguide Gasket kit Square Cover, Choke Flange, Non-Conductive

Waveguide Accessories Technical Data Sheet

PEWVK1004

Compliance Certifications (see [product page](#) for current document)

WR-75 Waveguide Gasket kit Square Cover, Choke Flange, Non-Conductive from Pasternack Enterprises has same day shipment for domestic and International orders. Our RF, microwave and millimeter wave products maintain a 99.4% availability and are part of the broadest selection in the industry.

Click the following link (or enter part number in "SEARCH" on website) to obtain additional part information including price, inventory and certifications: [WR-75 Waveguide Gasket kit Square Cover, Choke Flange, Non-Conductive PEWVK1004](#)

URL: <https://www.pasternack.com/wr-75-waveguide-gasket-kit-square-cover-choke-flange-non-conductive-pewvk1004-p.aspx>

The information contained in this document is accurate to the best of our knowledge and representative of the part described herein. It may be necessary to make modifications to the part and/or the documentation of the part, in order to implement improvements. Pasternack reserves the right to make such changes as required. Unless otherwise stated, all specifications are nominal. Pasternack does not make any representation or warranty regarding the suitability of the part described herein for any particular purpose, and Pasternack does not assume any liability arising out of the use of any part or documentation.

