

### 1. PART NO. EXPRESSION :

P I C 1 2 3 5 H P 1 R 0 M F - □ □  
 (a) (b) (c) (d) (e)(f) (g)

- (a) Series code
- (b) Dimension code
- (c) Type code

- (d) Inductance code : 1R0 = 1.0uH
- (e) Tolerance code : M = ±20%, Y = ±30%
- (f) F : RoHS Compliant
- (g) 11-99 : Internal controlled number

### 2. CONFIGURATION & DIMENSIONS :

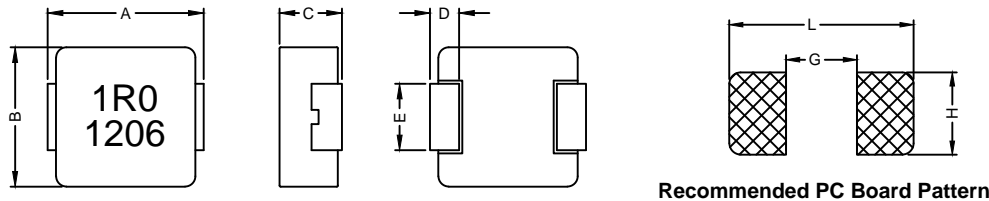

Unit:m/m

A	B	C	D	E	G	H	L
13.5±0.5	12.5±0.3	3.3±0.2	2.3±0.3	4.7±0.3	8.0	5.0	14.2

### 3. SCHEMATIC :

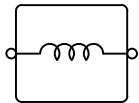

### 4. MATERIALS :

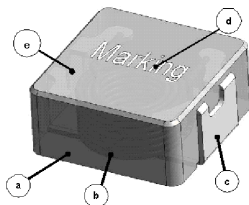

- (a) Core
- (b) Wire
- (c) Terminal
- (d) Ink
- (e) Paint

### 5. GENERAL SPECIFICATION :

- a) Test Freq. : L : 100KHz/1.0V
- b) Operating Temp. : -40°C to +125°C
- c) Storage Temp. : -40°C to +125°C
- d) Humidity Range : 85 ± 3% RH
- e) Heat Rated Current (Irms) will cause the coil temperature rise approximately Δt of 40°C (keep 1min)
- f) Saturation Current (Isat) will cause L0 to drop 20%.
- g) Part Temperature (Ambient+Temp. Rise) : Should not exceed 125°C under worst case operating conditions.
- h) Storage condition (component in its packaging)
  - i) Temperature: -10 to 40°C
  - ii) Humidity : 50~60% RH



**RoHS Compliant**

NOTE : Specifications subject to change without notice. Please check our website for latest information.

### 6. ELECTRICAL CHARACTERISTICS :

Part No.	Inductance Lo ( $\mu$ H) @ 0 A	I <sub>rms</sub> (A) Typ.	I <sub>sat</sub> (A) Typ.	DCR (m $\Omega$ ) Typ. @ 25°C	DCR (m $\Omega$ ) Max. @ 25°C
PIC1235HPR10YF	0.10	43	84	0.36	0.43
PIC1235HPR15YF	0.15	41	75	0.4	0.48
PIC1235HPR22MF	0.22	38.5	65	0.7	0.81
PIC1235HPR33MF	0.33	36.5	62	0.85	1.0
PIC1235HPR36MF	0.36	36	60	0.87	1.1
PIC1235HPR45MF	0.45	33	58	1.05	1.5
PIC1235HPR47MF	0.47	32	55	1.2	1.8
PIC1235HPR56MF	0.56	30	53	1.3	1.9
PIC1235HPR60MF	0.60	29	51	1.5	2.2
PIC1235HPR67MF	0.67	28	49	1.9	2.5
PIC1235HPR68MF	0.68	28	49	1.9	2.5
PIC1235HPR82MF	0.82	25	44	2.2	3.0
PIC1235HP1R0MF	1.00	24	40	2.7	3.5
PIC1235HP1R2MF	1.20	21	37	4.0	5.0
PIC1235HP1R5MF	1.50	19	35	4.8	5.5
PIC1235HP1R8MF	1.80	17	30	5.2	7.0
PIC1235HP2R2MF	2.20	16	29	6.3	8.0
PIC1235HP3R3MF	3.30	12	27	11	13.5
PIC1235HP4R7MF	4.70	10	24	15.3	18.5
PIC1235HP5R6MF	5.60	9.5	19	18	22
PIC1235HP6R8MF	6.80	9.0	18	20	24
PIC1235HP8R2MF	8.20	8.5	16	23	28
PIC1235HP100MF	10.0	7.0	14	29	34

Tolerance : M =  $\pm$ 20%, Y =  $\pm$ 30%



**RoHS Compliant**

NOTE : Specifications subject to change without notice. Please check our website for latest information.

06.11.2015



**SUPERWORLD ELECTRONICS (S) PTE LTD**

### 7. CHARACTERISTICS CURVES :

PIC1235HPR10YF

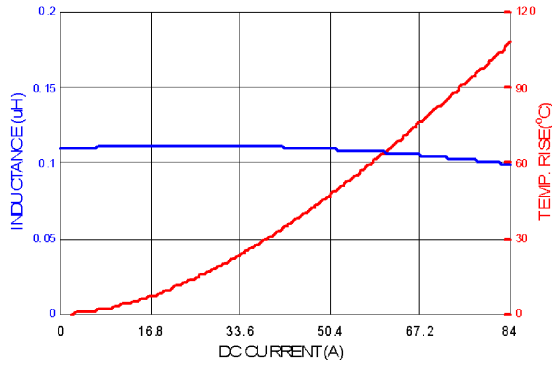

PIC1235HPR15YF

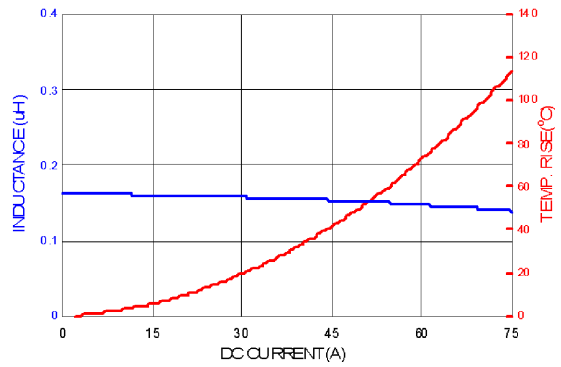

PIC1235HPR22MF

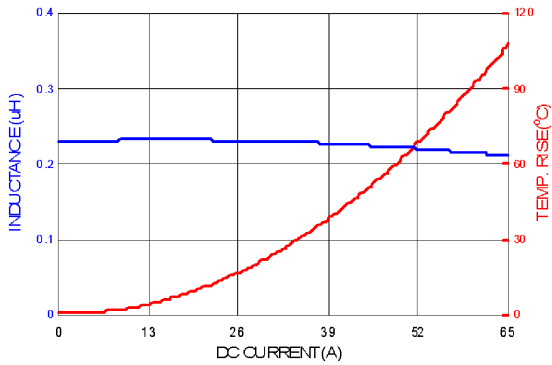

PIC1235HPR33MF

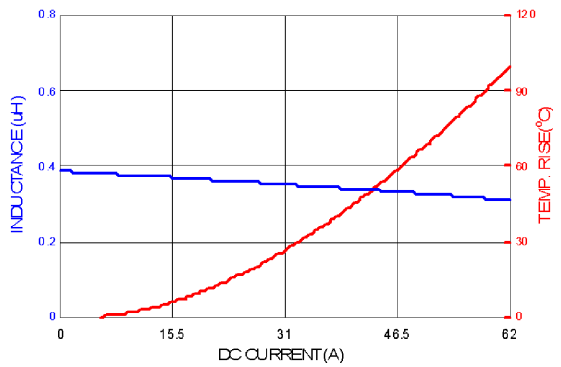

PIC1235HPR36MF

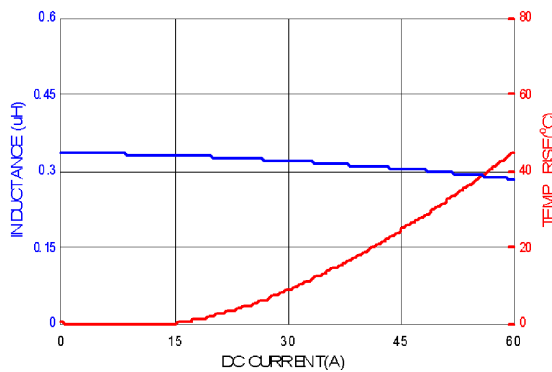

PIC1235HPR45MF

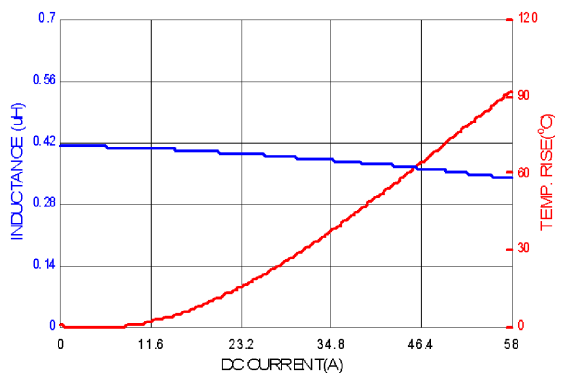

**RoHS Compliant**

NOTE : Specifications subject to change without notice. Please check our website for latest information.

06.11.2015



**SUPERWORLD ELECTRONICS (S) PTE LTD**

PIC1235HPR47MF

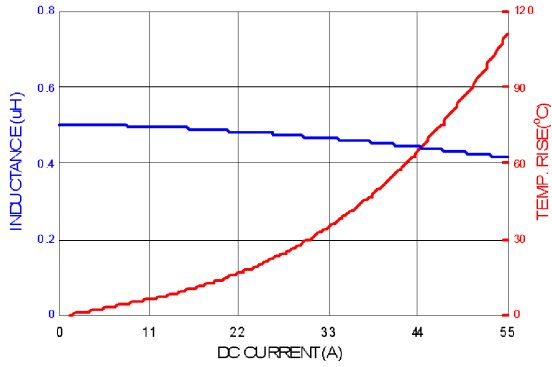

PIC1235HPR56MF

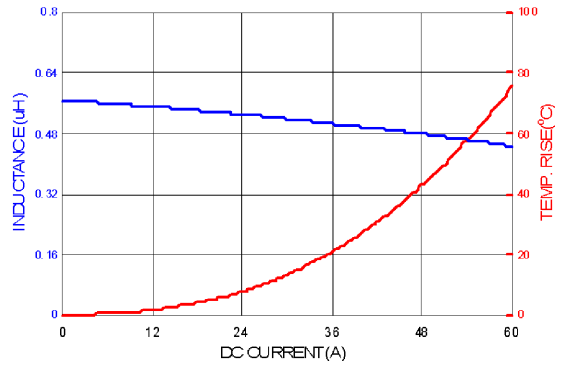

PIC1235HPR60MF

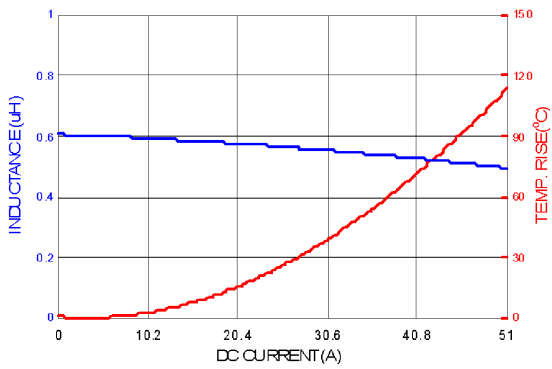

PIC1235HPR68MF

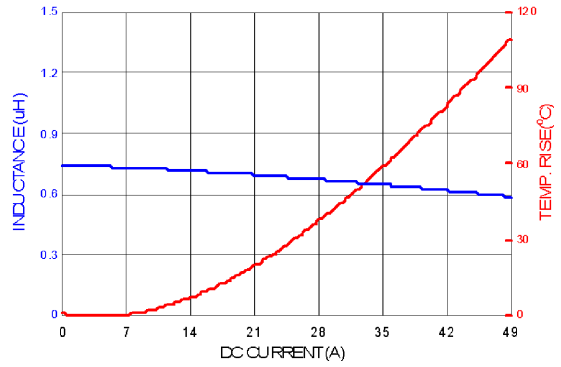

PIC1235HPR82MF

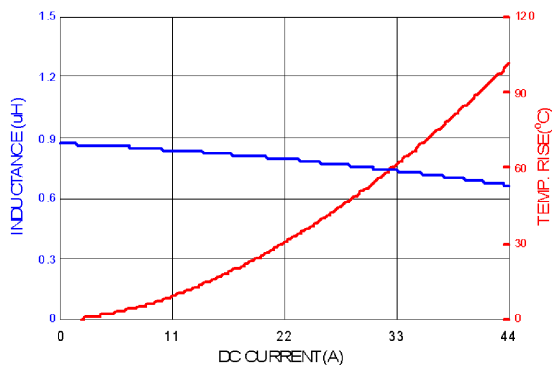

PIC1235HP1R0MF

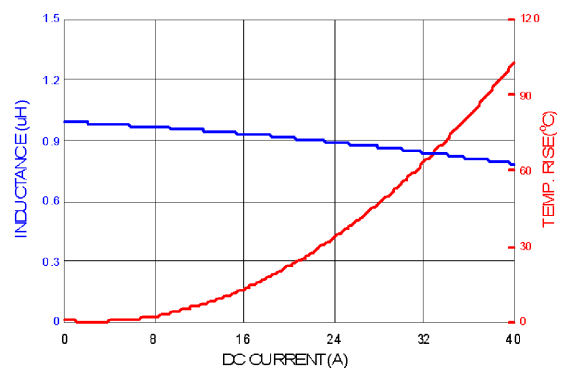

**RoHS Compliant**

NOTE : Specifications subject to change without notice. Please check our website for latest information.

06.11.2015



**SUPERWORLD ELECTRONICS (S) PTE LTD**

PIC1235HP1R2MF

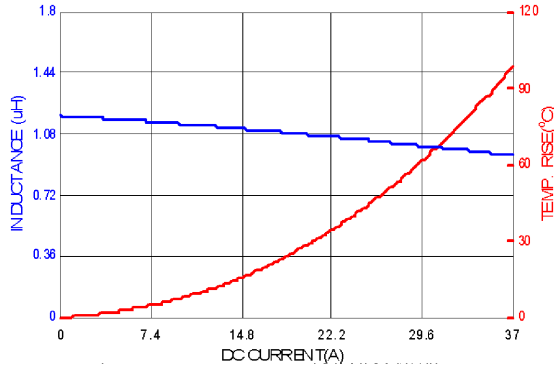

PIC1235HP1R5MF

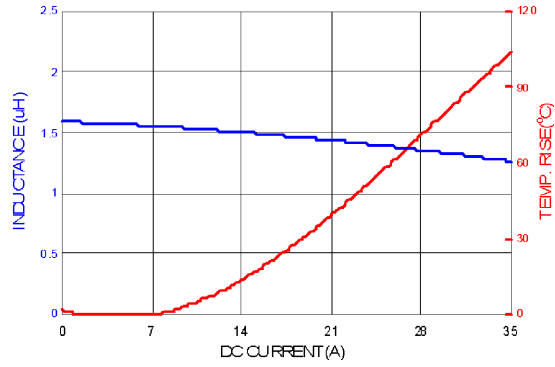

PIC1235HP1R8MF

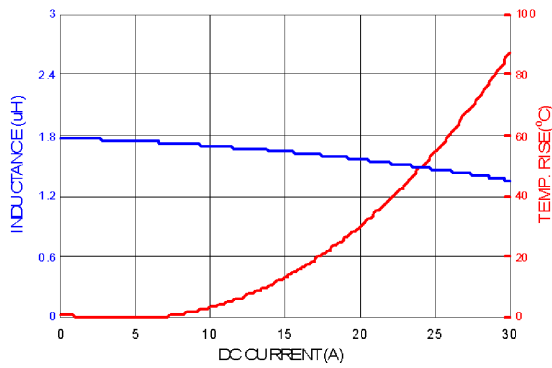

PIC1235HP2R2MF

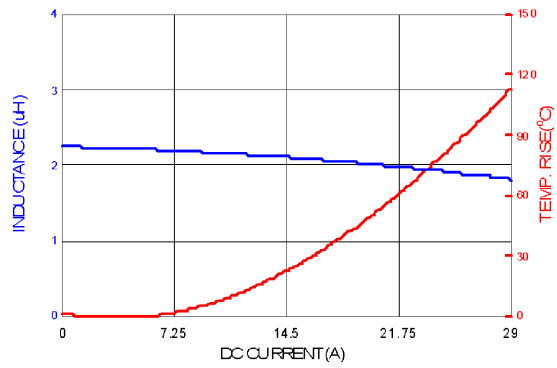

PIC1235HP3R3MF

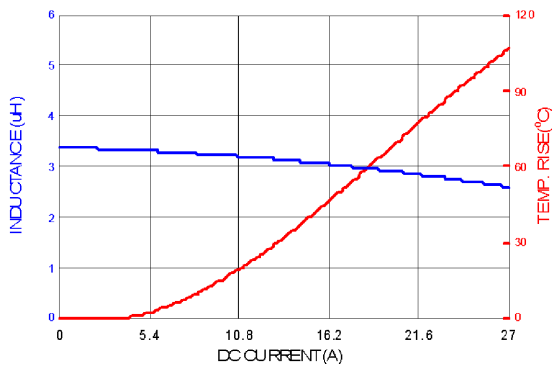

PIC1235HP4R7MF

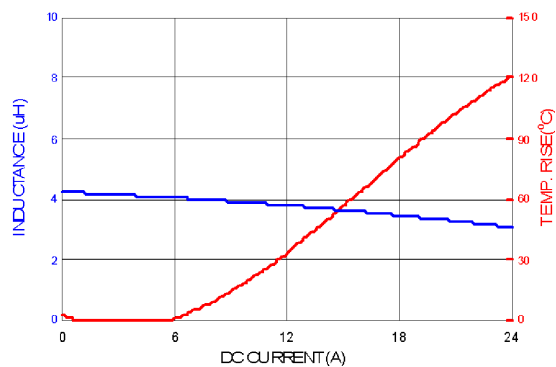

**RoHS Compliant**

NOTE : Specifications subject to change without notice. Please check our website for latest information.

06.11.2015



**SUPERWORLD ELECTRONICS (S) PTE LTD**

PIC1235HP5R6MF

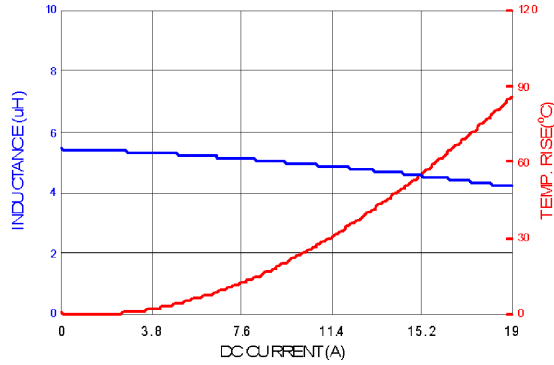

PIC1235HP6R8MF

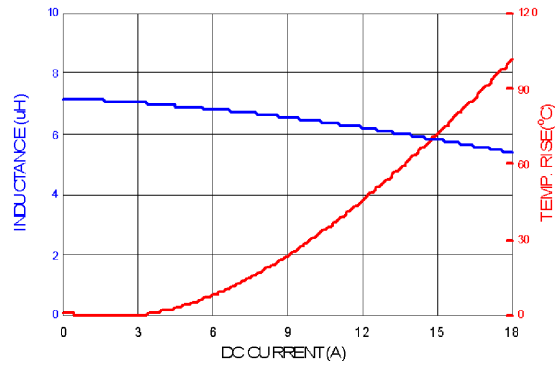

PIC1235HP8R2MF

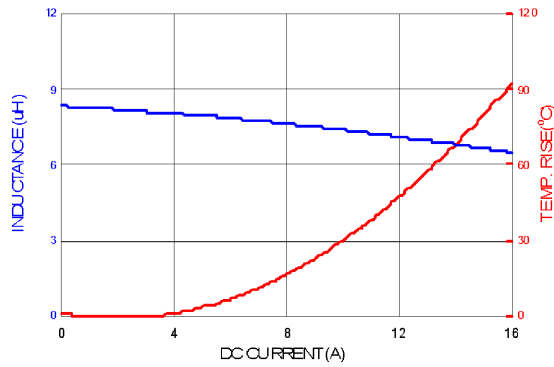

PIC1235HP100MF

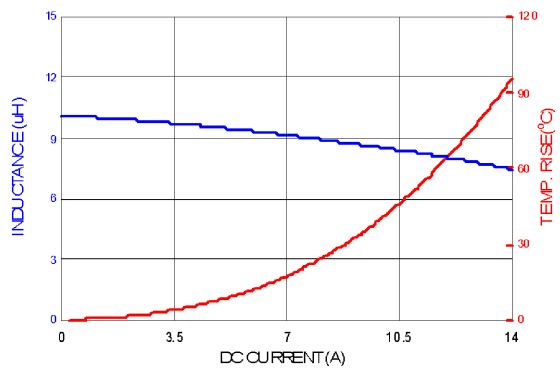

**RoHS Compliant**

NOTE : Specifications subject to change without notice. Please check our website for latest information.

06.11.2015



**SUPERWORLD ELECTRONICS (S) PTE LTD**

## 8. SOLDERING

Mildly activated rosin fluxes are preferred. The minimum amount of solder can lead to damage from the stresses caused by the difference in coefficients of expansion between solder, chip and substrate. Our terminations are suitable for all re-flow soldering systems. If hand soldering cannot be avoided, the preferred technique is the utilization of hot air soldering tools.

### 8-1.1 Solder Re-flow :

Recommended temperature profiles for re-flow soldering in Figure 1.

### 8-1.2 Soldering Iron (Figure 2) :

Products attachment with soldering iron is discouraged due to the inherent process control limitations. In the event that a soldering iron must be employed the following precautions are recommended.

Note :

- a) Preheat circuit and products to 150°C.
- b) 355°C tip temperature (max)
- c) Never contact the ceramic with the iron tip
- d) 1.0mm tip diameter (max)
- e) Use a 20 watt soldering iron with tip diameter of 1.0mm
- f) Limit soldering time to 4~5 secs.

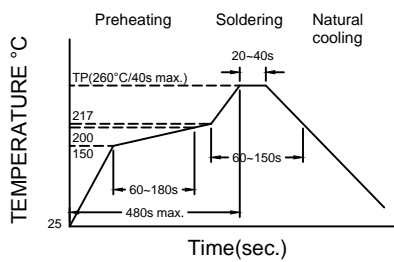

Figure 1. Re-flow Soldering: 3 times max.

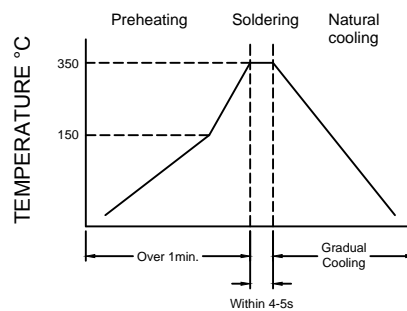

Figure 2. Hand Soldering: 1 times max.



**RoHS Compliant**

NOTE : Specifications subject to change without notice. Please check our website for latest information.

06.11.2015



**SUPERWORLD ELECTRONICS (S) PTE LTD**

### 9. PACKAGING INFORMATION :

#### 9-1. Reel Dimension

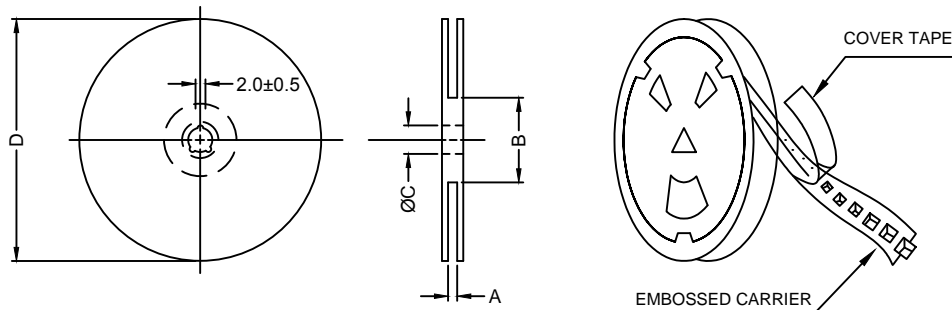

Type	A(mm)	B(mm)	C(mm)	D(mm)
13" x 24mm	24.4+2.0/-0	100±2.0	13.5±0.5	330

#### 9-2. Tape Dimension

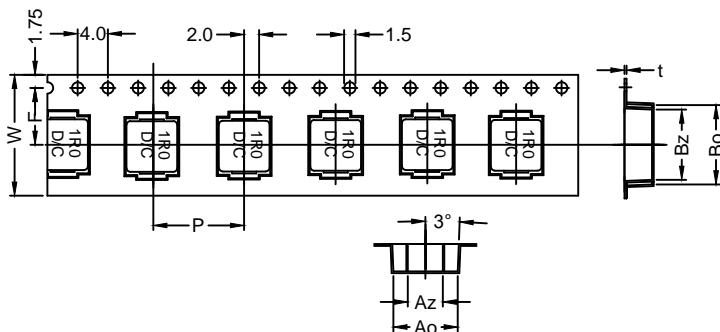

Series	Ao(mm)	Az(mm)	Bo(mm)	Bz(mm)	Ko(mm)	P(mm)	W(mm)	F(mm)	t(mm)
PIC1235	12.9±0.1	7.0±0.1	14.1±0.1	13.0±0.1	4.0±0.1	16.0±0.1	24±0.3	11.5±0.1	0.35±0.05

#### 9-3. Packaging Quantity

Size	PIC1235
Chip / Reel	500
Inner Box	1000
Carton	4000



**RoHS Compliant**

NOTE : Specifications subject to change without notice. Please check our website for latest information.

06.11.2015



**SUPERWORLD ELECTRONICS (S) PTE LTD**



### 9-4. Tearing Off Force

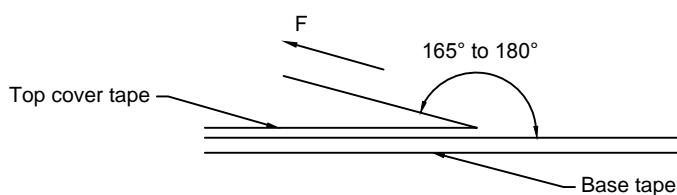

The force for tearing off cover tape is 10 to 130 grams in the arrow direction under the following conditions. (referenced ANSI/EIA-481-C-2003 of 4.11 standard)

Room Temp. (°C)	Room Humidity (%)	Room atm (hPa)	Tearing Speed (mm/min)
5~35	45~85	860~1060	300

### Application Notice

#### 1. Storage Conditions :

To maintain the solderability of terminal electrodes :

- a) Recommended products should be used within 12 months from the time of delivery.
- b) The packaging material should be kept where no chlorine or sulfur exists in the air.

#### 2. Transportation :

- a) Products should be handled with care to avoid damage or contamination from perspiration and skin oils.
- b) Vacuum pick up is strongly recommended for individual components.
- c) Bulk handling should ensure that abrasion and mechanical shock are minimized.



**RoHS Compliant**

NOTE : Specifications subject to change without notice. Please check our website for latest information.

06.11.2015



**SUPERWORLD ELECTRONICS (S) PTE LTD**