

描述 / Descriptions

SOT-23 塑封封装 NPN 半导体三极管。Silicon NPN transistor in a SOT-23 Plastic Package.

特征 / Features

与 8550MG 互补。无卤产品。
Complementary pair with 8550MG.HF Product.

用途 / Applications

用于功率放大电路。
Power amplifier applications.

内部等效电路 / Equivalent Circuit

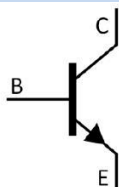

引脚排列 / Pinning



PIN1 : Base PIN 2 : Emitter PIN 3 : Collector

放大及印章代码 / h_{FE} Classifications & Marking

h_{FE} Classifications Symbol	B	C	D
h_{FE} Range	85~160	120~200	160~300
Marking	GY1B	GY1C	GY1D

极限参数 / Absolute Maximum Ratings(Ta=25°C)

参数 Parameter	符号 Symbol	数值 Rating	单位 Unit
Collector to Base Voltage	V_{CBO}	40	V
Collector to Emitter Voltage	V_{CEO}	25	V
Emitter to Base Voltage	V_{EBO}	6.0	V
Collector Current	I_C	1.5	A
Base Current	I_B	0.5	A
Collector Power Dissipation	P_C	625	mW
Junction Temperature	T_j	150	°C
Storage Temperature Range	T_{stg}	-55~150	°C

电性能参数 / Electrical Characteristics(Ta=25°C)

参数 Parameter	符号 Symbol	测试条件 Test Conditions	最小值 Min	典型值 Typ	最大值 Max	单位 Unit
Collector to Base Breakdown Voltage	V_{CBO}	$I_C=0.1mA$ $I_E=0$	40			V
Collector to Emitter Breakdown Voltage	V_{CEO}	$I_C=2.0mA$ $I_B=0$	25			V
Emitter to Base Breakdown Voltage	V_{EBO}	$I_E=0.1mA$ $I_C=0$	6.0			V
Collector Cut-Off Current	I_{CBO}	$V_{CB}=35V$ $I_E=0$			0.1	μA
Emitter Cut-Off Current	I_{EBO}	$V_{EB}=6.0V$ $I_C=0$			0.1	μA
DC Current Gain	$h_{FE(1)}$	$V_{CE}=1.0V$ $I_C=100mA$	85		300	
	$h_{FE(2)}$	$V_{CE}=1.0V$ $I_C=800mA$	40			
	$h_{FE(3)}$	$V_{CE}=1.0V$ $I_C=5.0mA$	45			
Collector-Emitter Saturation Voltage	$V_{CE(sat)}$	$I_C=800mA$ $I_B=80mA$		0.28	0.5	V
Base-Emitter Saturation Voltage	$V_{BE(sat)}$	$I_C=800mA$ $I_B=80mA$		0.98	1.2	V
Base-Emitter Voltage	V_{BE}	$V_{CE}=1.0V$ $I_C=10mA$		0.66	1.0	V
Transition Frequency	f_T	$V_{CE}=10V$ $I_C=50mA$	100	190		MHz
Collector Output Capacitance	C_{ob}	$V_{CB}=10V$ $I_E=0$ $f=1.0MHz$		9.0		pF

电参数曲线图 / Electrical Characteristic Curve

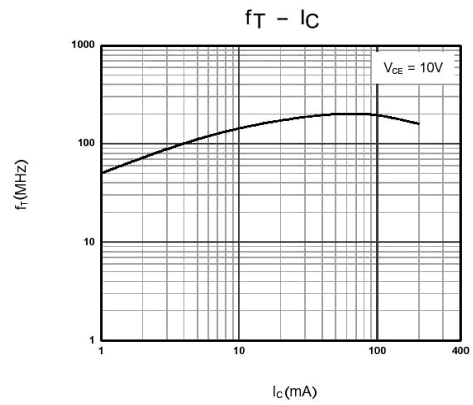
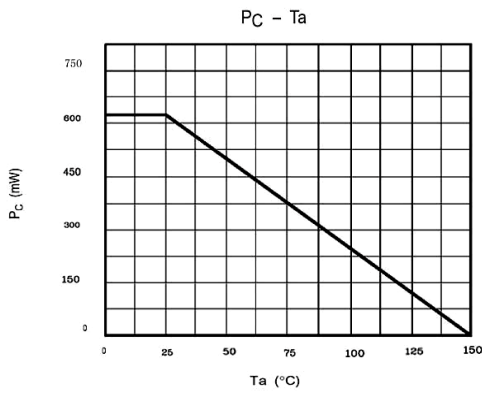
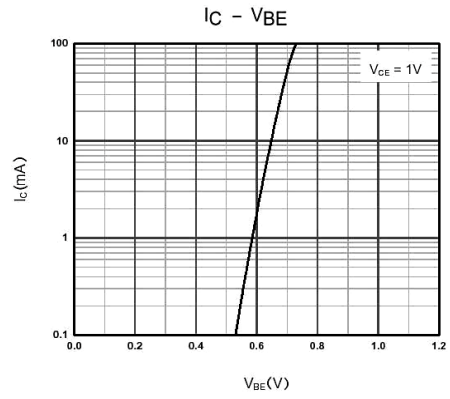
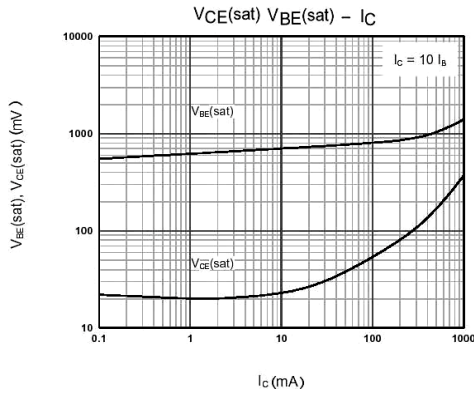
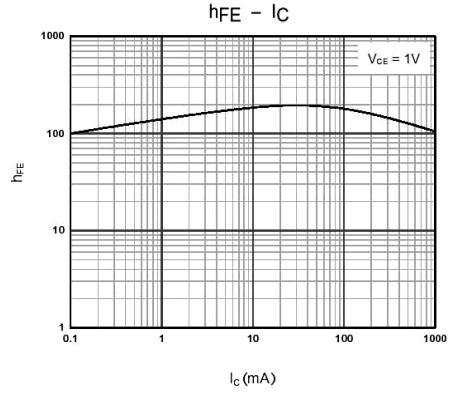
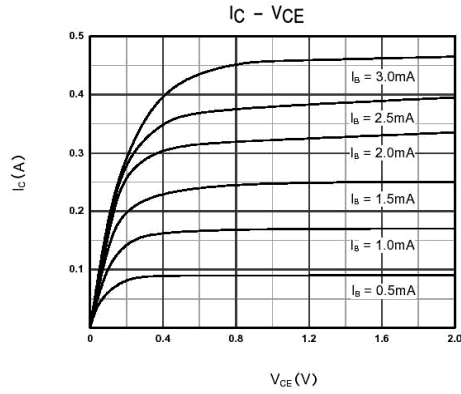

外形尺寸图 / Package Dimensions

SOT-23

单位: mm

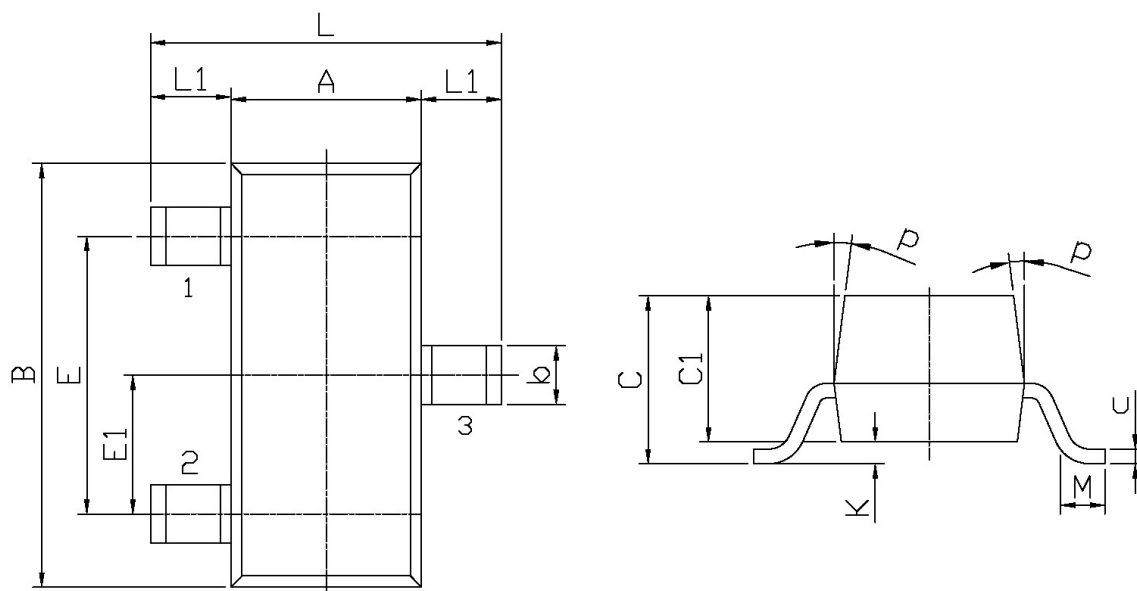

Symbol	Dimensions In Millimeters		Symbol	Dimensions In Millimeters	
	Min	Max		Min	Max
L	2.2	2.7	C	1.30Max	
L1	0.45	0.65	C1	0.90	1.20
A	1.15	1.50	c	0.05	0.20
B	2.70	3.10	K	0	0.10
E	1.70	2.10	M	0.20MIN	
E1	0.85	1.05	P	7°	
b	0.35	0.55			

印章说明 / Marking Instructions

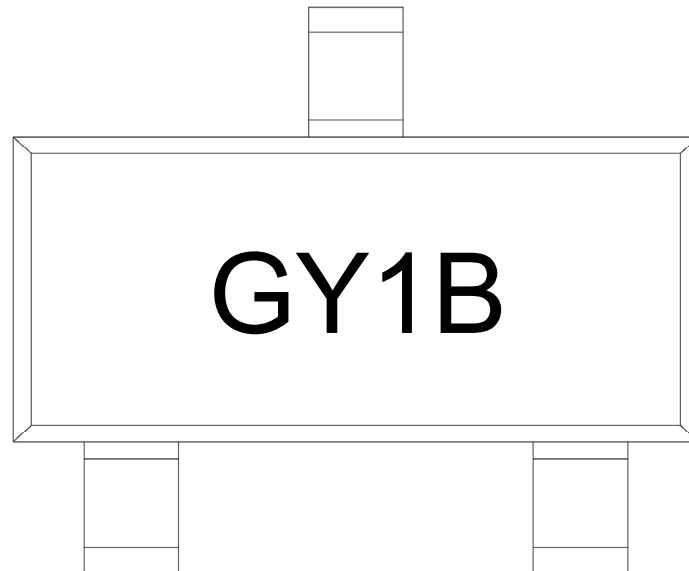

说明：

G： 为无卤产品代码

Y1： 为型号代码

B： 为 h_{FE} 档次代码

Note:

G： Halogen Free Product Code

Y1： Product Type Code

B： h_{FE} Classifications Symbol Code

回流焊温度曲线图(无铅) / Temperature Profile for IR Reflow Soldering(Pb-Free)



说明：

- 1、预热温度 25 ~ 150°C，时间 60 ~ 90sec;
- 2、峰值温度 245±5°C，时间持续为 5±0.5sec;
- 3、焊接制程冷却速度为 2 ~ 10°C/sec.

Note:

- 1.Preheating:25~150°C, Time:60~90sec.
- 2.Peak Temp.:245±5°C, Duration:5±0.5sec.
3. Cooling Speed: 2~10°C/sec.

耐焊接热试验条件 / Resistance to Soldering Heat Test Conditions

温度：260±5°C

时间：10±1 sec.

Temp.:260±5°C

Time:10±1 sec

包装规格 / Packaging SPEC.

卷盘包装 / REEL

Package Type 封装形式	Units 包装数量					Dimension 包装尺寸 (unit: mm ³)		
	Units/Reel 只/卷盘	Reels/Inner Box 卷盘/盒	Units/Inner Box 只/盒	Inner Boxes/Outer Box 盒/箱	Units/Outer Box 只/箱	Reel	Inner Box 盒	Outer Box 箱
SOT-23	3,000	10	30,000	6	180,000	7" ×8	180×120×180	390×385×205

使用说明 / Notices