

## LARISA-W-PIN

~50° wide beam and holder with location pins

### TECHNICAL SPECIFICATIONS:

Dimensions	9.9 +9.9 mm
Height	7.5 mm
Fastening	glue, pin
Colour	black
Box size	254 x 298 x 241 mm
Box weight	7.1 kg
Quantity in Box	10000 pcs
ROHS compliant	yes ⓘ



### MATERIAL SPECIFICATIONS:

Component	Type	Material	Colour
LARISA-W	Lens	PMMA	clear
LARISA-HOLDER-PIN	Holder	PC	black

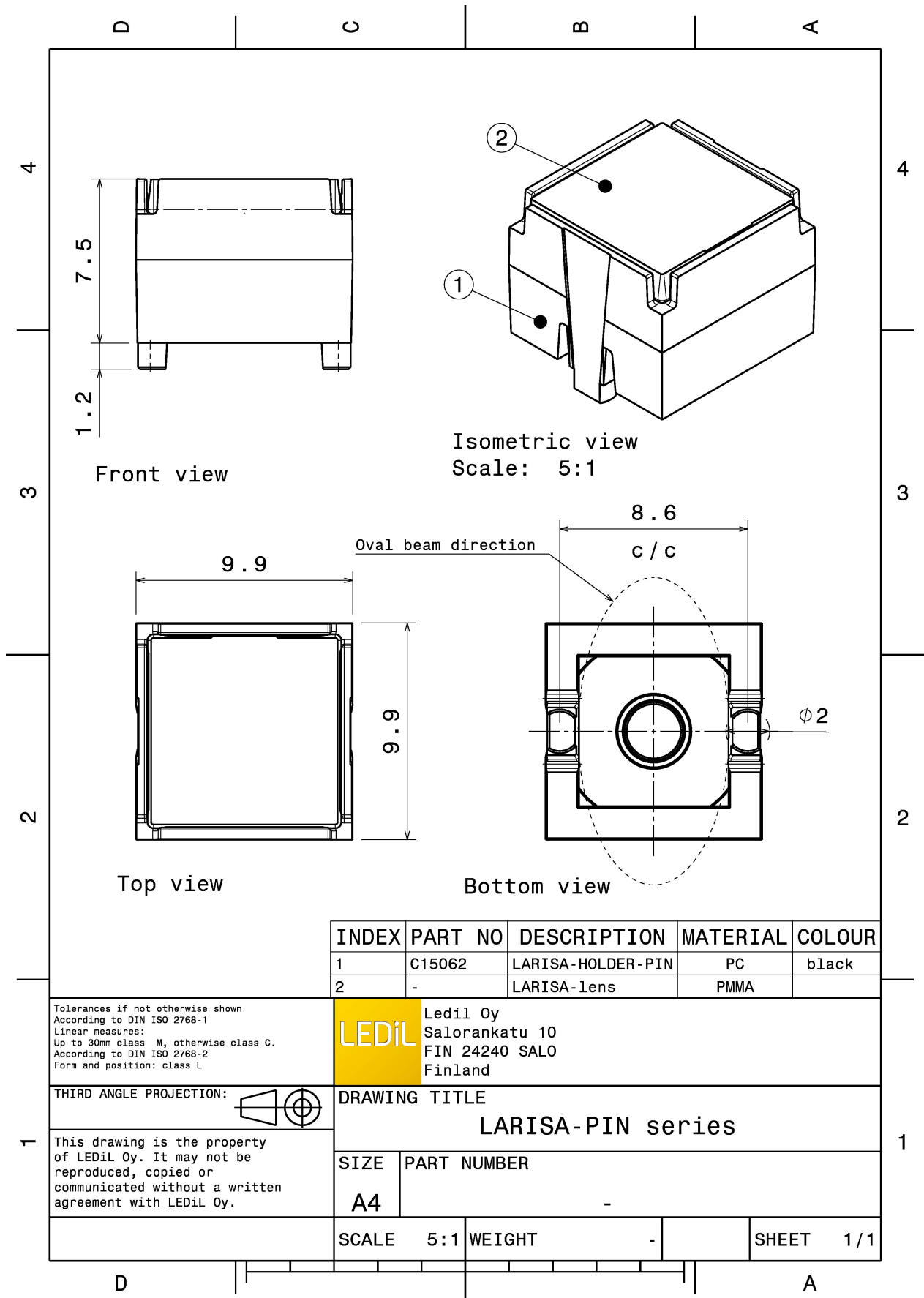

#### PHOTOMETRIC DATA (MEASURED):



LED XB-D  
 FWHM 43.0°  
 Efficiency 79 %  
 Peak intensity 1.300 cd/lm  
 Required components:

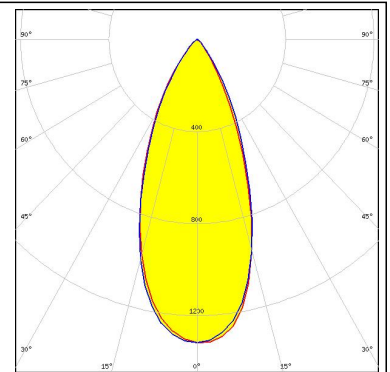
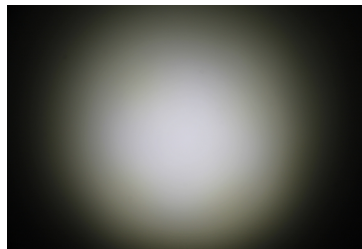

LED XQ-E  
 FWHM 46.0°  
 Efficiency 84 %  
 Peak intensity 1.200 cd/lm  
 Required components:

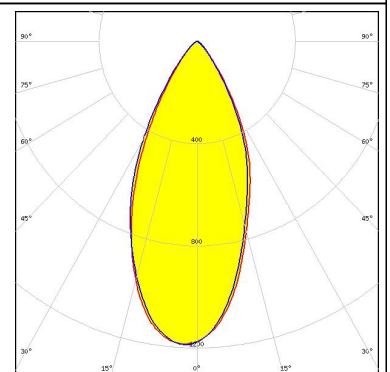
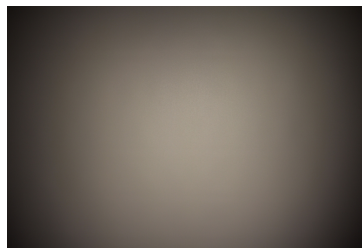

LED LUXEON C  
 FWHM 43.0°  
 Efficiency 85 %  
 Peak intensity 1.500 cd/lm  
 Required components:

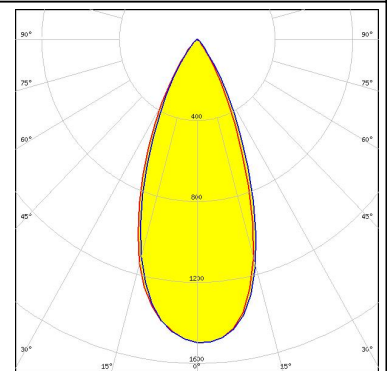
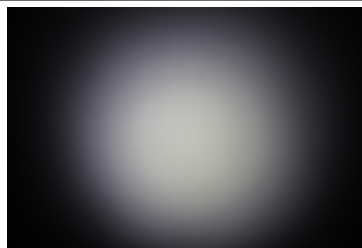

LED NCSxE17A  
 FWHM 30.0°  
 Efficiency 75 %  
 Peak intensity 2.100 cd/lm  
 Required components:

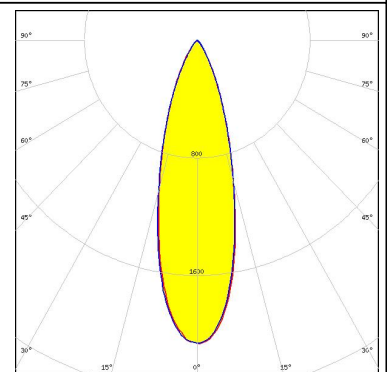
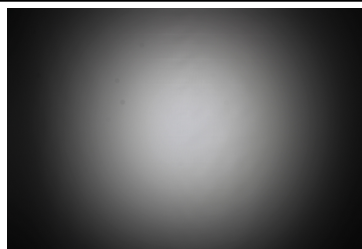

## PHOTOMETRIC DATA (MEASURED):



LED NVSxE21A  
FWHM 32.0°  
Efficiency 73 %  
Peak intensity 1.800 cd/lm  
Required components:

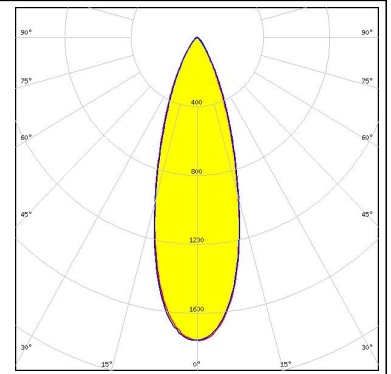

### PHOTOMETRIC DATA (SIMULATED):

**OSRAM**  
Opto Semiconductors

LED                    Oslon SSL 80  
FWHM                49.0°  
Efficiency            83 %  
Peak intensity      1.160 cd/lm  
Required components:

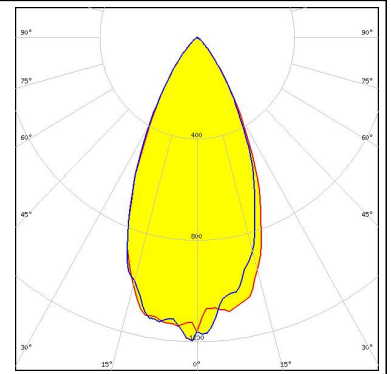

#### GENERAL INFORMATION:

NOTE: The typical beam angle will be changed by different color, chip size and chip position tolerance. The typical total beam angle is the full angle measured where the luminous intensity is half of the peak value.

#### MATERIALS:

As part of our continuous research and improvement processes, and to ensure the best possible quality and availability of our products, LEDiL reserves the right to change material grades without notice.

#### PRODUCT DATA USER AGREEMENT AND DISCLAIMER:

The measured data in the provided downloadable LEDiL Product Datasheets and Mechanical 2D-Drawings is rounded and provided as reference for planning. LEDiL Oy's optical specifications have been verified by conducting performance testing of the products in accordance with the company's quality system. The reported data are averaged results of multiple measurements with typical variation. LEDiL Oy reserves the right to without prior notification make changes and improvements to its products.

LEDiL Oy assumes neither warranty, nor guarantee nor any other liability of any kind for the contents and correctness of the provided data. The provided data has been generated with highest diligence but the provided data may in reality not represent the complete possible variation range of all intrinsic parameters. Therefore, in certain cases a deviation from the provided data could occur.

LEDiL Oy reserves the right to undertake technical changes of its products without further notification which could lead to changes in the provided data. LEDiL Oy assumes no liability of any kind for the possible deviation from any provided data or any other damage resulting from the usage of the provided data.

The user agrees to this disclaimer and user agreement with the download or usage of the provided files.

#### LEDiL Oy

Joensuunkatu 13  
FI-24240 SALO  
Finland

#### LEDiL Inc.

228 West Page Street  
Suite D  
Sycamore IL 60178  
USA

#### Local sales and technical support

[www.ledil.com/where\\_to\\_buy](http://www.ledil.com/where_to_buy)

#### Shipping locations

Salo, Finland  
Hong Kong, China

#### Distribution Partners

[www.ledil.com/where\\_to\\_buy](http://www.ledil.com/where_to_buy)