

Data Sheet

Description

Avago Technologies' ASMB-6WD0/6WZ0 is a tricolor LED in thin DFN6 packaging. It is designed with 6 separate leads enabling higher flexibility in circuitry design for the control of individual color. This LED offers high reliability, high intensity light output and a wide viewing angle making it ideally suited for amusement and pachinko machine application.

For easy pick & place, the LEDs are shipped in tape and reel form. Each reel is shipped from a single intensity and color bin to provide better intensity and color uniformity. These tricolor LEDs are compatible with reflow soldering process.

Features

- Diffused encapsulation for uniform light up appearance
- High brightness using AlInGaP and InGaN die technology
- Wide viewing angle
- Compatible with reflow soldering process
- Binned in White color for superior color uniformity
- With or without ESD protection

Applications

- Amusement lighting
- Decorative lighting
- Audio system illumination
- Gaming machine

CAUTION These LEDs are ESD sensitive. Please observe appropriate precautions during handling and processing. Refer to Avago Application Note AN-1142 for additional details.

CAUTION It is advised that LEDs are kept in the MBB when not in use, as prolonged exposure to environment might cause the silver plated leads to tarnish, which might cause difficulties in soldering.

Package Dimensions

With ESD Protection

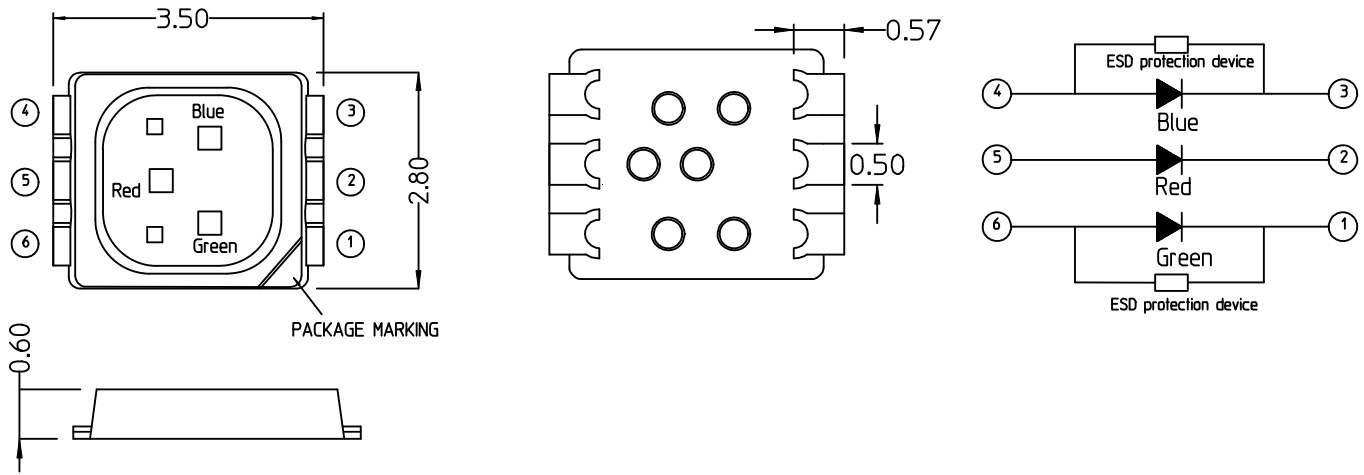

Without ESD Protection

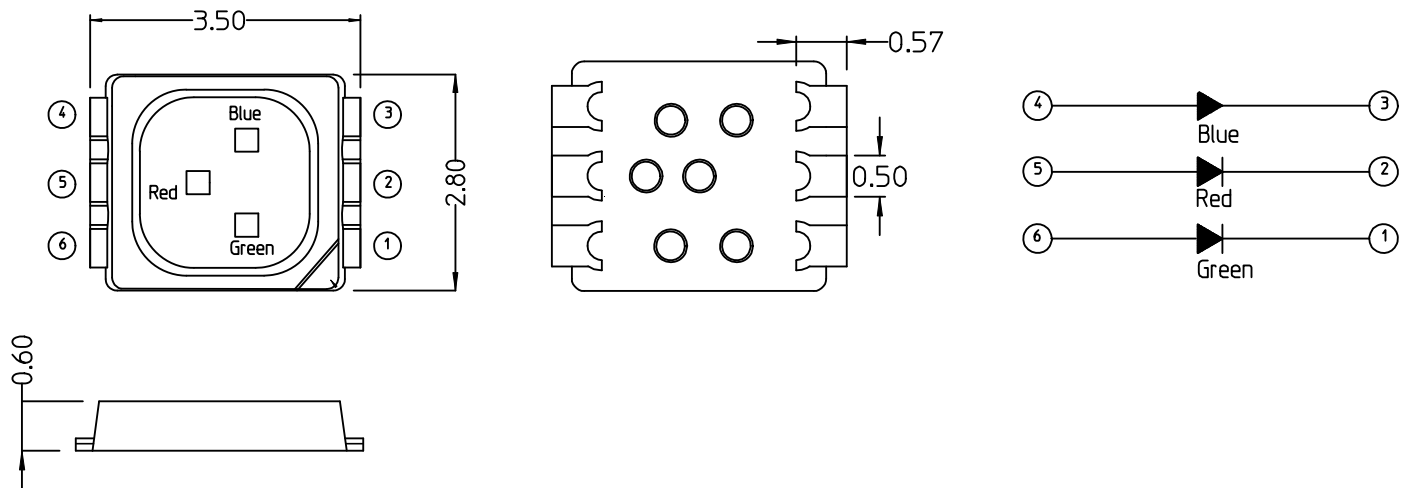

Lead	Configuration
1	Cathode(Green)
2	Cathode(Red)
3	Cathode (Blue)
4	Anode (Blue)
5	Anode (Red)
6	Anode (Green)

Notes:

1. All dimensions are in millimeter (mm).
2. Unless otherwise specified, tolerance is ± 0.2 mm.
3. Encapsulation = silicone
4. Terminal finish = silver plating

Device Selection Guide

Part Number	ESD Protection
ASMB-6WD0-0A101	Without ESD protection
ASMB-6WZ0-0A101	With ESD protection

Absolute Maximum Ratings ($T_J = 25\text{ }^\circ\text{C}$)

Parameter	Red	Green & Blue	Unit
DC forward current	50	30	mA
Peak forward current ^[1]	100	100	mA
Power dissipation	130	111	mW
Reverse voltage	Not recommended for reverse bias		
Junction temperature	100		$^\circ\text{C}$
Operating temperature range	-40 to +85		$^\circ\text{C}$
Storage temperature range	-40 to +100		$^\circ\text{C}$

Notes:

1. Duty factor = 10%, frequency = 1 KHz.

Optical Characteristics (T_J = 25 °C)

Individual Color Light Up

Color	Luminous Intensity, I _v (mcd) ^[1]			Dominant Wavelength, λ _d (nm) ^[2]			Test Current, I _F (mA)
	Min.	Typ.	Max.	Min.	Typ.	Max.	
Red	500	750	1150	618	624	628	20
Green	1000	1800	2400	520	524	530	
Blue	220	340	500	462	466	472	

RGB Mix White

Color	Luminous Intensity, I _v (mcd) ^[1]			Chromaticity Coordinate	Test Current, I _F (mA)
	Min	Typ	Max	Typ	
Red	1600	1900	2600	0.30, 0.30	14
Green					11
Blue					9

- Notes:
1. The luminous intensity I_v is measured at the mechanical axis of LED package and it is tested with single current pulse. The actual peak of the spatial radiation pattern may not be aligned with the axis.
 2. The dominant wavelength is derived from the CIE Chromaticity Diagram and represents the perceived color of the device.

Electrical Characteristics (T_J = 25 °C)

Color	Forward Voltage, V _F (V) @ I _F = 20mA ^[1]			Reverse Voltage, V _R @ 10μA ^[2]	Reverse Voltage, V _R @ 10μA ^[2, 3]	Thermal Resistance, Rθ _{J-5} (°C/W)	
	Min	Typ	Max	Min	Min	1 Chip On	3 Chips On
						Typ	Typ
Red	1.8	2.1	2.6	4	4	240	240
Green	2.7	3.0	3.7	4	NA	320	320
Blue	2.7	3.0	3.7	4	NA	320	320

- Notes:
1. Tolerance ± 0.1 V.
 2. Indicates product final test condition. Long terms reverse bias is not recommended.
 3. For part number with ESD protection.

Bin Information

Intensity Bins (CAT)

Bin ID	Luminous intensity (mcd)	
	Min	Max
A	1600	2600

Tolerance: $\pm 12\%$

Chromaticity Diagram

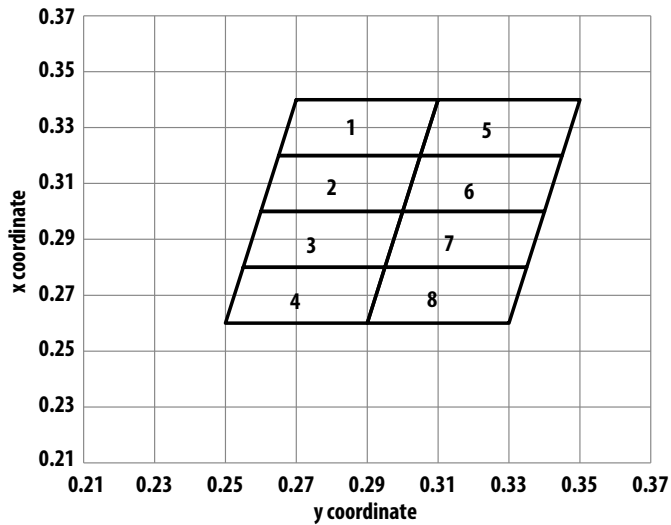

White Color Bins (BIN)

Bin ID	Chromaticity Coordinate	
	Cx	Cy
1	0.270	0.340
	0.265	0.320
	0.305	0.320
	0.310	0.340
2	0.265	0.320
	0.260	0.300
	0.300	0.300
	0.305	0.320
3	0.260	0.300
	0.255	0.280
	0.295	0.280
4	0.300	0.300
	0.255	0.280
	0.250	0.260
	0.290	0.260
5	0.295	0.280
	0.310	0.340
	0.305	0.320
	0.345	0.320
6	0.350	0.340
	0.305	0.320
	0.300	0.300
	0.340	0.300
7	0.345	0.320
	0.300	0.300
	0.295	0.280
	0.335	0.280
8	0.340	0.300
	0.295	0.280
	0.290	0.260
	0.330	0.260
	0.335	0.280

Tolerance: ± 0.01

Performance

Figure 1 Relative Intensity vs Wavelength

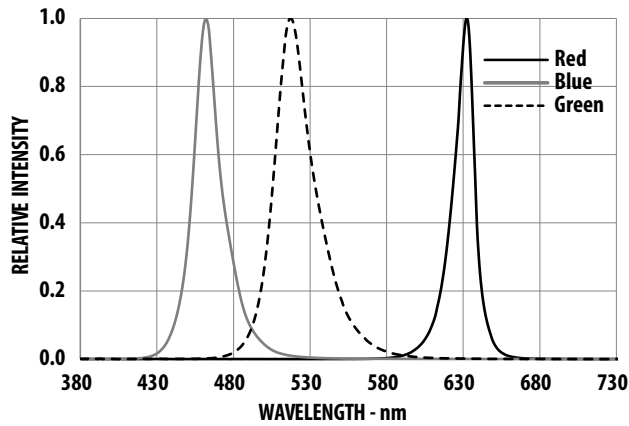

Figure 2 Forward Current vs Forward Voltage

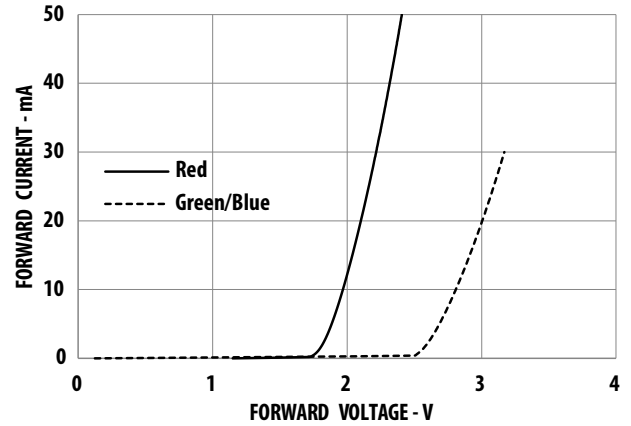

Figure 3 Relative Intensity vs Forward Current

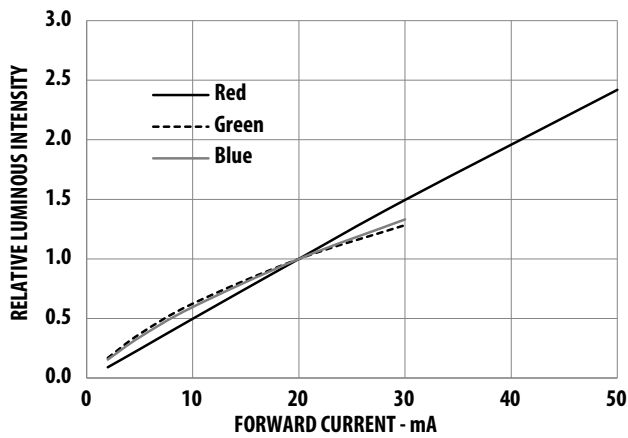

Figure 4 Dominant Wavelength Shift vs Forward Current

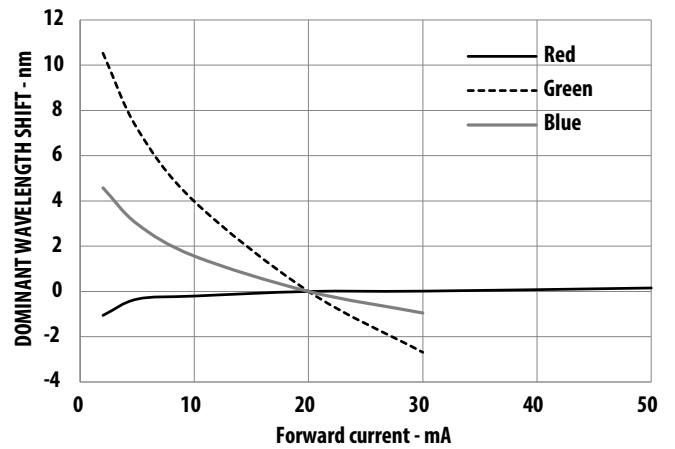

Figure 5 Relative Intensity vs Junction Temperature

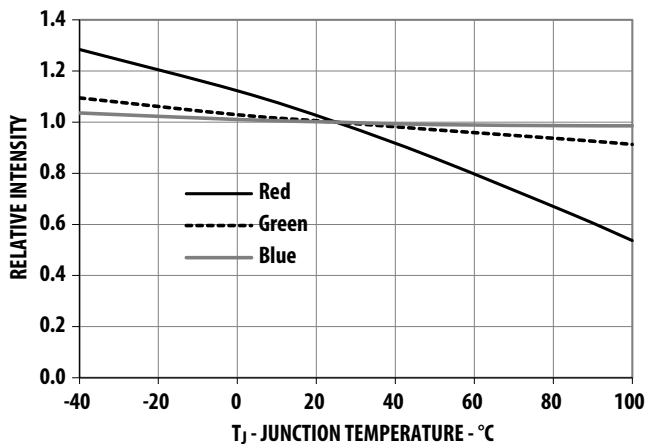

Figure 6 Forward Voltage vs Junction Temperature

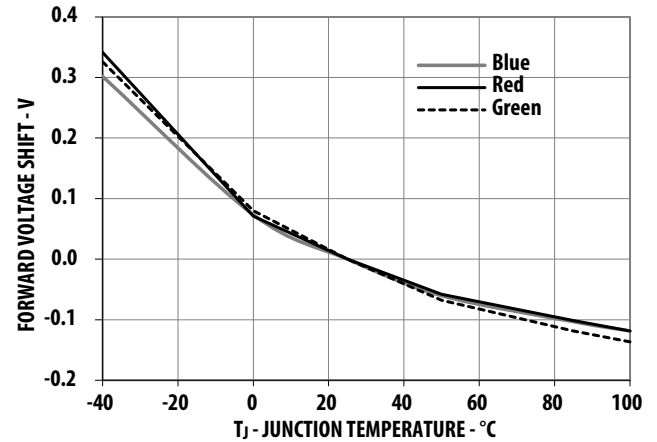

Figure 7 Maximum Forward Current vs Temperature for Red (1 chip on)

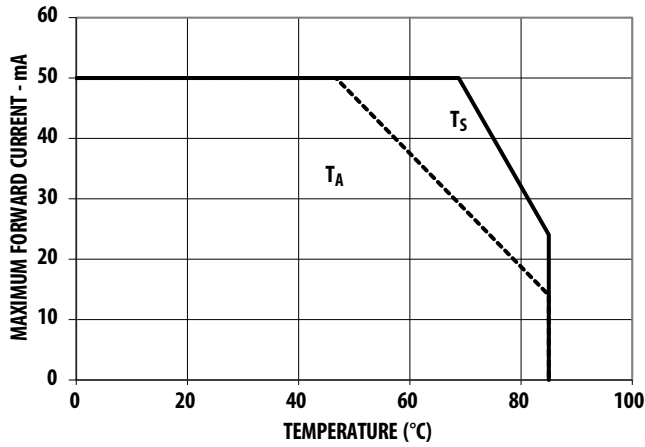

Figure 8 Maximum Forward Current vs Temperature for Red (3 chips on)

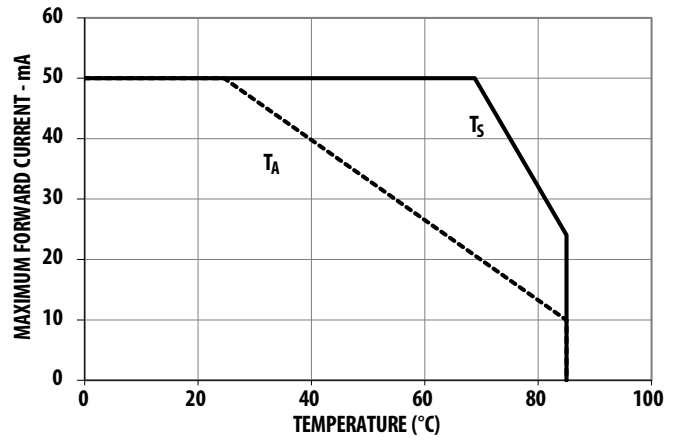

Figure 9 Maximum Forward Current vs Temperature for Green & Blue (1 chip on)

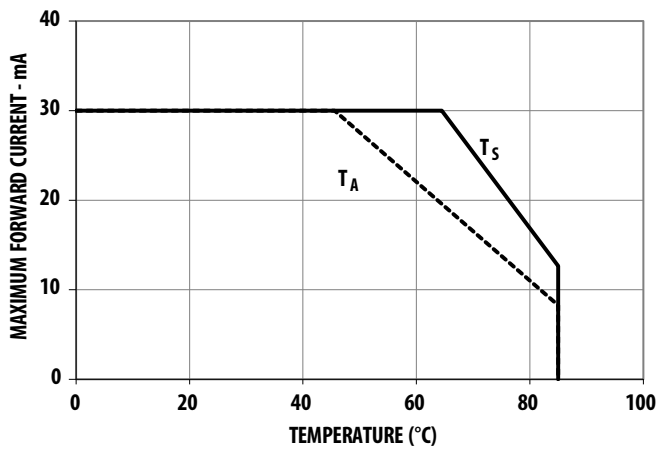
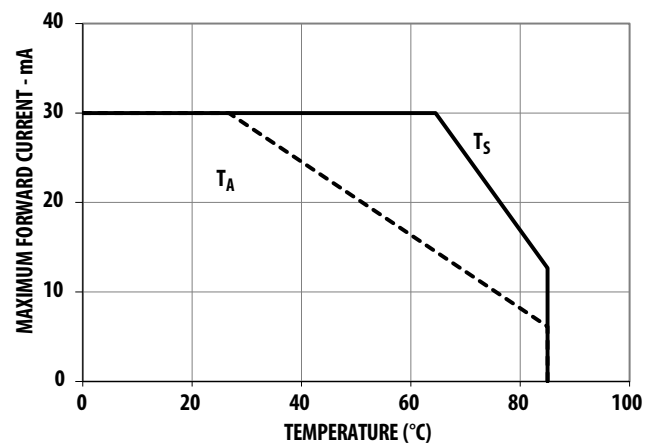

Figure 10 Maximum Forward Current vs Temperature for Green & Blue (3 chips on)



Note:
Maximum forward current graphs based on ambient temperature, T_A are with reference to thermal resistance $R\theta_{J-A}$ below.

Condition	Thermal Resistance from LED Junction to Ambient, $R\theta_{J-A}$ (°C/W)	
	Red	Green / Blue
1 chip on	410	490
3 chips on	580	660

Figure 11 Radiation Pattern along X-axis of the Package

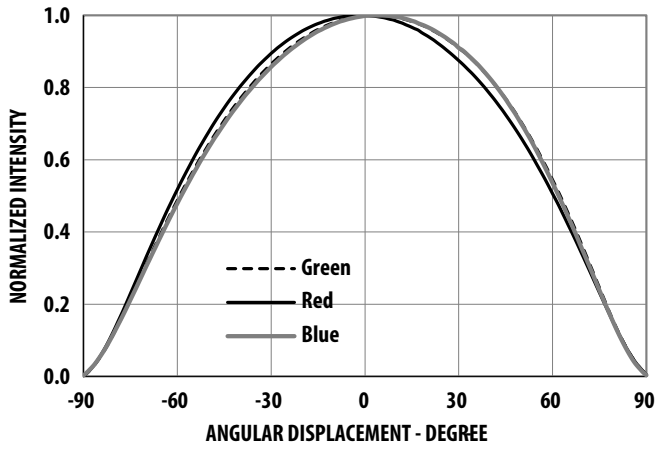

Figure 12 Radiation Pattern along Y-axis of the Package

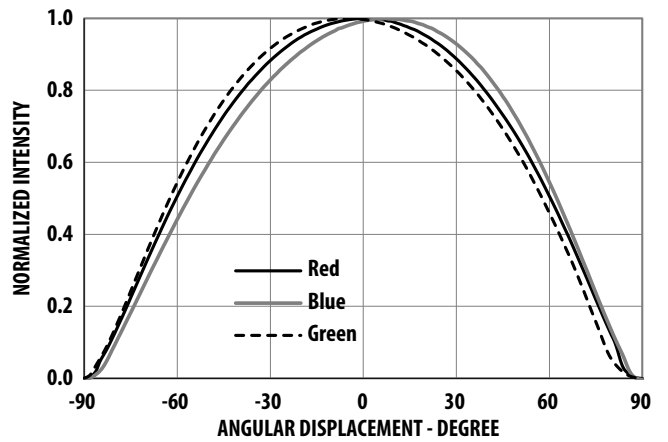

Figure 13 Illustration of Package Axis for Radiation Pattern

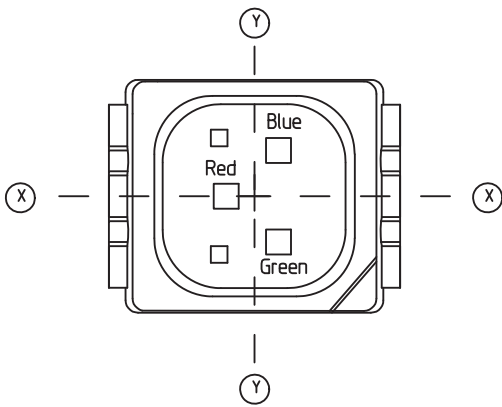
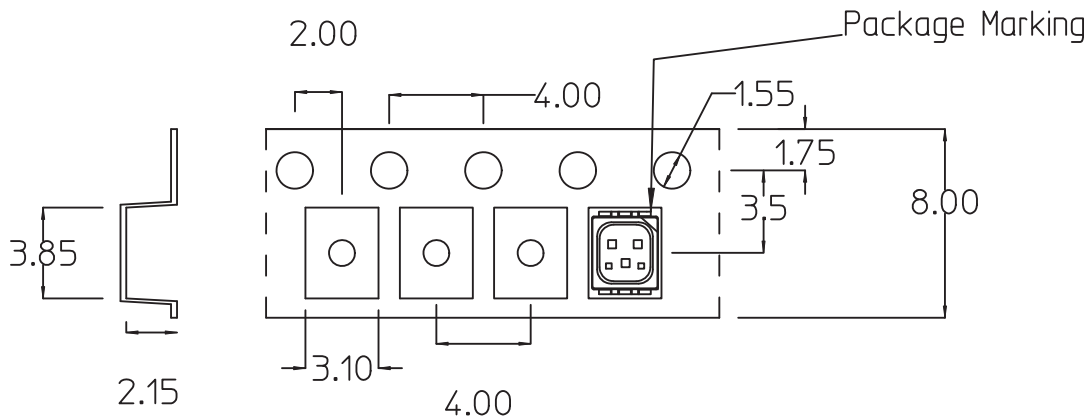

Figure 14 Carrier Tape



Note: All dimension in mm, tolerance is ± 0.20 unless otherwise specific

Reel Dimensions and Orientation

Figure 15 Reel Dimensions

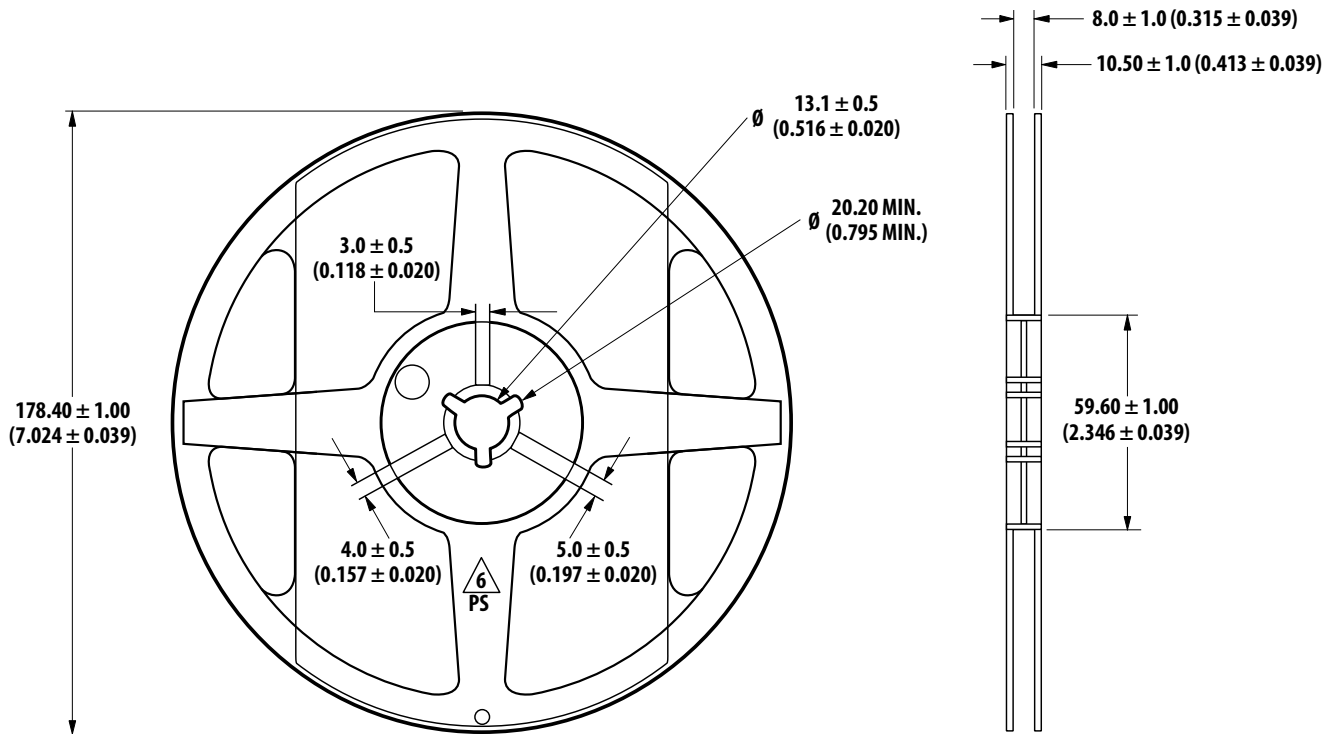
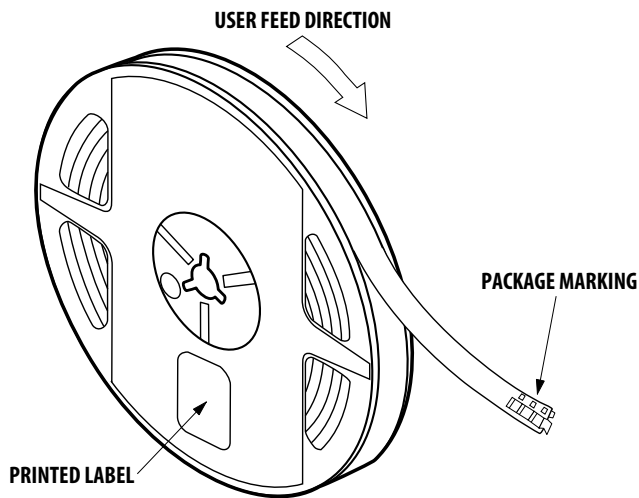

Figure 16 Reeling Orientation









Packing Label

Standard Label (attached on moisture barrier bag)

 Avago TECHNOLOGIES	
(1P) Item: Part Number 	STANDARD LABEL LS0002 RoHS Compliant Halogen Free e4 Max Temp 260C MSL4
(1T) Lot: Lot Number 	(Q) QTY: Quantity 
LPN: 	CAT: Intensity Bin 
(9D)MFG Date: Manufacturing Date 	BIN: Color Bin 
(P) Customer Item: 	
(V) Vendor ID: 	(9D) Date Code: Date Code 
DeptID: 	Made In: Country of Origin 

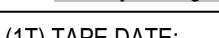
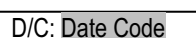
Baby Label (attached on plastic reel)

 Avago TECHNOLOGIES BABY LABEL COSB001B V0.0	
(1P) PART #: Part Number 	
(1T) LOT #: Lot Number 	
(9D)MFG DATE: Manufacturing Date 	QUANTITY: Packing Quantity 
C/O: Country of Origin 	(9D): DATE CODE: 
(1T) TAPE DATE: 	D/C: Date Code VF: CAT: INTENSITY BIN BIN: COLOR BIN

Soldering

Recommended lead free reflow soldering condition:

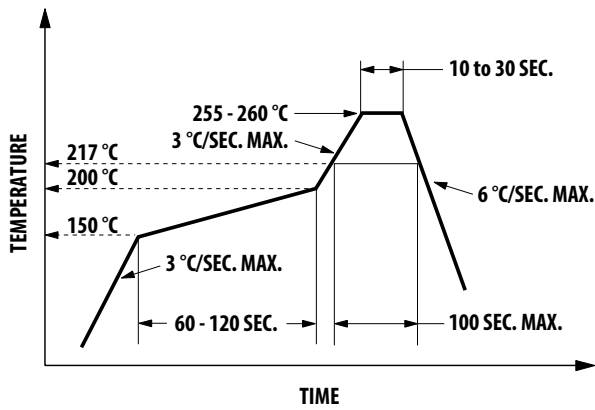

- Reflow soldering must not be done more than 2 times. Do observe necessary precautions of handling moisture sensitive device as stated in below section.
- Recommended land pattern and recommended board reflow direction:

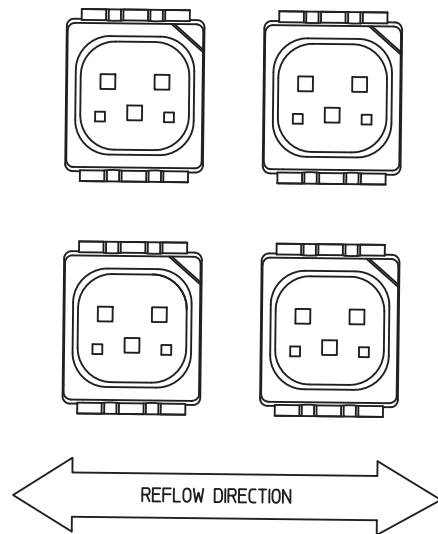
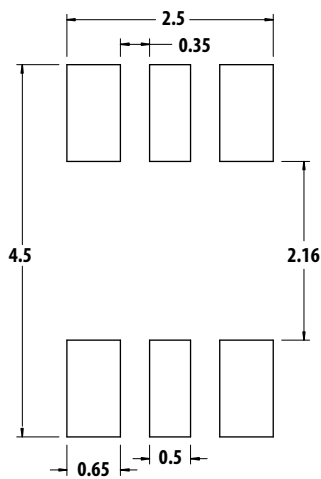

- Do not apply any pressure or force on the LED during reflow and after reflow when the LED is still hot.
- Do not touch the LED body with hot soldering iron except the soldering terminals as it may cause damage to the LED.
- For de-soldering, it is recommended to use suitable soldering iron tip.
- User is advised to confirm beforehand whether the functionality and performance of the LED is affected by hand soldering.

Precautionary Notes

Handling Precautions

- a. Do not poke sharp objects into the encapsulant. Sharp object like tweezers or syringes might apply excessive force or even pierce through the encapsulant and induce failures to the LED die or wire bond.
- b. Do not touch the encapsulant. Uncontrolled force acting on the encapsulant might result in excessive stress on the wire bond. The LED should only be held by the body.
- c. Do not stack assembled PCBs together. Use an appropriate rack to hold the PCBs.
- d. To remove foreign particles on the surface of encapsulant, a cotton bud can be used with isopropyl alcohol (IPA). During cleaning, rub the surface gently without putting much pressure. Ultrasonic cleaning is not recommended.
- e. For automated pick and place, Avago has tested nozzle size below to be working fine with this LED. However, due to the possibility of variations in other parameters such as pick and place machine maker/model and other settings of the machine, customer is recommended to verify the nozzle selected will not cause damage to the LED.

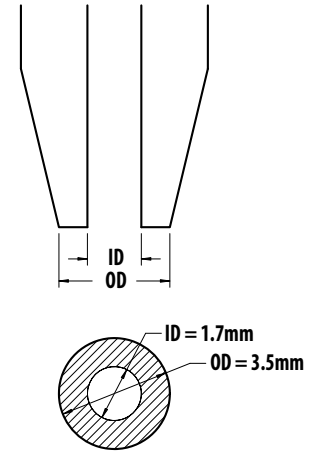

Handling of Moisture Sensitive Device

This product has a Moisture Sensitive Level 4 rating per JEDEC J-STD-020. Refer to Avago Application Note AN5305, Handling of Moisture Sensitive Surface Mount Devices, for additional details and a review of proper handling procedures.

- a. Before use
 - An unopened moisture barrier bag (MBB) can be stored at $<40^{\circ}\text{C}/90\%\text{RH}$ for 12 months. If the actual shelf life has exceeded 12 months and the humidity Indicator Card (HIC) indicates that baking is not required, then it is safe to reflow the LEDs per the original MSL rating.
 - It is recommended that the MBB not be opened prior to assembly (e.g. for IQC).
- b. Control after opening the MBB
 - The humidity indicator card (HIC) shall be read immediately upon opening of MBB.
 - The LEDs must be kept at $<30^{\circ}\text{C} / 60\%\text{RH}$ at all times and all high temperature related processes including soldering, curing or rework need to be completed within 72 hours.
- c. Control for unfinished reel
 - Unused LEDs must be stored in a sealed MBB with desiccant or desiccator at $<5\%\text{RH}$.
- d. Control of assembled boards
 - If the PCB soldered with the LEDs is to be subjected to other high temperature processes, the PCB need to be stored in sealed MBB with desiccant or desiccator at $<5\%\text{RH}$ to ensure that all LEDs have not exceeded their floor life of 72 hours.
- e. Baking is required if:
 - The HIC indicator is not BLUE at 10% and is PINK at 5%.
 - The LEDs are exposed to condition of $>30^{\circ}\text{C} / 60\% \text{RH}$ at any time.
 - The LED floor life exceeded 72hrs.
 - The recommended baking condition is: $60\pm 5^{\circ}\text{C}$ for 24hrs
 - Baking should be performed only once.
- f. Storage
 - The soldering terminals of these Avago LEDs are silver plated. If the LEDs are exposed in ambient environment for too long, the silver plating might be oxidized and thus affecting its solderability performance. As such, unused LEDs must be kept in sealed MBB with desiccant or in desiccator at $<5\%\text{RH}$.

Application Precautions

- Drive current of the LED must not exceed the maximum allowable limit across temperature as stated in the datasheet. Constant current driving is recommended to ensure consistent performance.
- LEDs do exhibit slightly different characteristics at different drive currents that might result in larger performance variations (i.e., intensity, wavelength, and forward voltage). The user is recommended to set the application current as close as possible to the test current to minimize these variations.
- LED is not intended for reverse bias. Do use other appropriate components for such purpose. When driving the LED in matrix form, it is crucial to ensure that the reverse bias voltage is not exceeding the allowable limit of the LED.
- Do not use the LED in the vicinity of material with sulfur content, in environment of high gaseous sulfur compound and corrosive elements. Examples of material that may contain sulfur are rubber gasket, RTV (room temperature vulcanizing) silicone rubber, rubber gloves etc. Prolonged exposure to such environment may affect the optical characteristics and product life.
- Avoid rapid change in ambient temperature especially in high humidity environment as this will cause condensation on the LED.
- Number of reflow cycle and reflow temperature condition used may affect optical characteristics of the LED. It is recommended to use LEDs with the same number of reflow cycle and same reflow temperature condition within the same finished good.

Thermal Management

Optical, electrical and reliability characteristics of LED are affected by temperature. The junction temperature (T_J) of the LED must be kept below allowable limit at all times. T_J can be calculated as below:

$$T_J = T_A + R_{\theta_{J-A}} \times I_F \times V_{F_{max}}$$

where T_A = ambient temperature [°C]

R_{θ_{J-A}} = thermal resistance from LED junction to ambient [°C/W]

I_F = forward current [A]

V_{F_{max}} = maximum forward voltage [V]

The complication of using this formula lies in T_A and R_{θ_{J-A}}. Actual T_A is sometimes subjective and hard to determine. R_{θ_{J-A}} varies from system to system depending on design and is usually not known.

Another way of calculating T_J is by using solder point temperature T_S as shown below:

$$T_J = T_S + R_{\theta_{J-S}} \times I_F \times V_{F_{max}}$$

where T_S = LED solder point temperature as shown in illustration below [°C]

R_{θ_{J-S}} = thermal resistance from junction to solder point [°C/W]

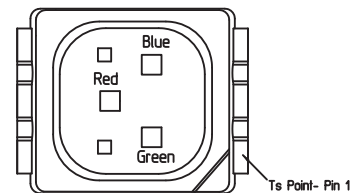

T_S can be measured easily by mounting a thermocouple on the soldering joint as shown in illustration above, while R_{θ_{J-S}} is provided in the datasheet. User is advised to verify the T_S of the LED in the final product to ensure that the LEDs are operated within all maximum ratings stated in the datasheet.

Eye Safety Precautions

LEDs may pose optical hazards when in operation. It is not advisable to view directly at operating LEDs as it may be harmful to the eyes. For safety reasons, use appropriate shielding or personal protective equipment.

For product information and a complete list of distributors, please go to our web site:
www.avagotech.com

Avago Technologies and the A logo are trademarks of Avago Technologies in the United States and other countries. All other brand and product names may be trademarks of their respective companies.

This data sheet (including, without limitation, the Avago component[s] identified herein) is not designed, intended, or certified for use in any military, nuclear, medical, mass transportation, aviation, navigations, pollution control, hazardous substances management, or other high-risk application. Avago provides this data sheet "as-is," without warranty of any kind. Avago disclaims all warranties, expressed and implied, including, without limitation, the implied warranties of merchantability, fitness for a particular purpose, and noninfringement.

Data subject to change. Copyright © 2015–2016 Avago Technologies. All Rights Reserved.

pub-005359 – June 3, 2016

AVAGO
TECHNOLOGIES



Lead (Pb) Free
RoHS 6 fully
compliant