

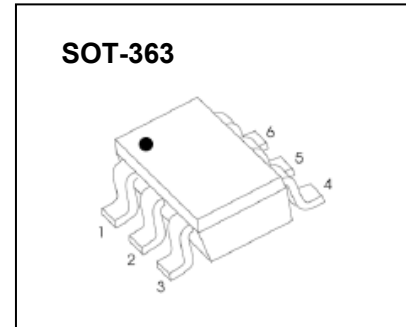

SOT-363 Power Management MOSFETs-Schottky

CJ7203KDW N-channel MOSFET and Schottky Barrier Diode

$V_{(BR)DSS}/V_R$	$R_{DS(on)MAX}$	I_D/I_O
60V	5Ω@10V	340mA
	5.3Ω@5V	
40V	/	350mA



FEATURE

- High density cell design for Low $R_{DS(on)}$
- High saturation current capability
- Low Forward Voltage Drop
- Guard Ring Construction for Transient Protection
- Negligible Reverse Recovery Time
- Low Capacitance

APPLICATION

- Load Switch for Portable Devices
- DC/DC Converter

MARKING

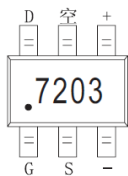

Equivalent Circuit

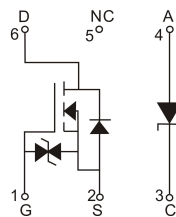

MAXIMUM RATINGS ($T_a=25^{\circ}C$ unless otherwise noted)

Symbol	Parameter	Value	Unit
B-MOSFET			
V_{DS}	Drain-Source Voltage	60	V
V_{GS}	Gate-Source Voltage	±20	V
I_D	Continuous Drain Current	0.34	A
I_{DM}^*	Pulse Drain Current	1.36	A
Schottky Barrier Diode			
V_{RRM}	Peak Repetitive Reverse Voltage	40	V
V_R	DC Blocking Voltage	40	V
I_O	Average Rectified Forward Current	0.35	A
Power Dissipation, Temperature and Thermal Resistance			
P_D	Power Dissipation	0.15	W
$R_{\theta JA}$	Thermal Resistance from Junction to Ambient	833	$^{\circ}C/W$
T_j	Junction Temperature	150	$^{\circ}C$
T_{stg}	Storage Temperature	-55~+150	$^{\circ}C$
T_L	Lead Temperature for Soldering Purposes(1/8" from case for 10 s)	260	$^{\circ}C$

*Repetitive rating: Pluse width limited by junction temperature.

MOSFET ELECTRICAL CHARACTERISTICS

$T_a=25^\circ\text{C}$ unless otherwise specified

Parameter	Symbol	Test Condition	Min	Typ	Max	Units
B-MOSFET						
Static Characteristics						
Drain-Source Breakdown Voltage	V_{DS}	$V_{GS} = 0V, I_D = 250\mu A$	60			V
Gate Threshold Voltage*	$V_{GS(th)}$	$V_{DS} = V_{GS}, I_D = 1mA$	1	1.3	2.5	V
Zero Gate Voltage Drain Current	I_{DSS}	$V_{DS} = 48V, V_{GS} = 0V$			1	μA
Gate –Source leakage current	I_{GSS1}	$V_{GS} = \pm 20V, V_{DS} = 0V$			± 10	μA
	I_{GSS2}	$V_{GS} = \pm 10V, V_{DS} = 0V$			± 200	nA
	I_{GSS3}	$V_{GS} = \pm 5V, V_{DS} = 0V$			± 100	nA
Drain-Source On-Resistance*	$R_{DS(on)}$	$V_{GS} = 4.5V, I_D = 200mA$		1.1	5.3	Ω
		$V_{GS} = 10V, I_D = 500mA$		0.9	5	Ω
Diode Forward Voltage	V_{SD}	$V_{GS} = 0V, I_S = 300mA$			1.5	V
Recovered charge	Q_r	$V_{GS} = 0V, I_S = 300mA, V_R = 25V, di/dt = -100A/\mu S$		30		nC
Dynamic Characteristics**						
Input Capacitance	C_{iss}	$V_{DS} = 10V, V_{GS} = 0V, f = 1MHz$			40	pF
Output Capacitance	C_{oss}				30	pF
Reverse Transfer Capacitance	C_{rss}				10	pF
Switching Characteristics**						
Turn-On Delay Time	$t_{d(on)}$	$V_{GS} = 10V, V_{DD} = 50V, R_G = 50\Omega, R_{GS} = 50\Omega, R_L = 250\Omega$			10	ns
Turn-Off Delay Time	$t_{d(off)}$				15	ns
Reverse recovery Time	t_{rr}	$V_{GS} = 0V, I_S = 300mA, V_R = 25V, di/dt = -100A/\mu S$		30		ns
GATE-SOURCE ZENER DIODE						
Gate-Source Breakdown Voltage	BV_{GSO}	$I_{gs} = \pm 1mA$ (Open Drain)	± 21.5		± 30	V
SCHOTTKY BARRIER DIODE						
Reverse voltage	$V_{(BR)}$	$I_R = 100\mu A$	40			V
Reverse current	I_R	$V_R = 30V$			5	μA
Forward voltage	V_F	$I_F = 20mA$			0.37	V
		$I_F = 200mA$			0.6	
Total capacitance	C_{tot}	$V_R = 0V, f = 1MHz$		50		pF
Reverse recovery time	t_{rr}	$I_F = I_R = 200mA, I_{rr} = 0.1 \times I_R, R_L = 100\Omega$		10		ns

Notes :

*Pulse Test : Pulse Width $\leq 300\mu s$, Duty Cycle $\leq 2\%$.

**These parameters have no way to verify.

Typical Characteristics

N-channel Characteristics

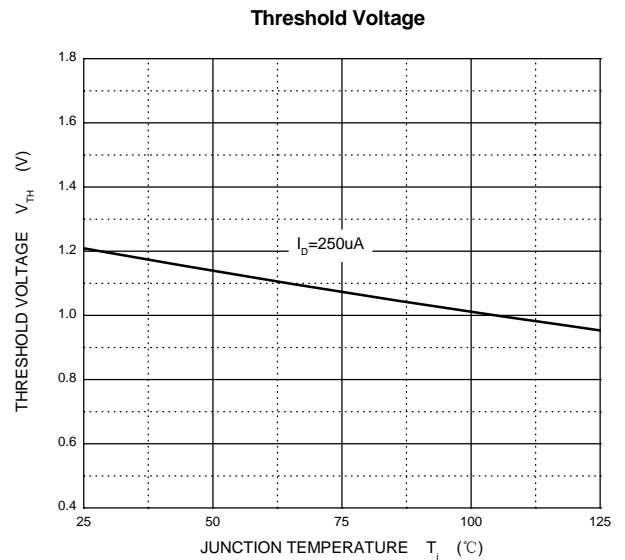
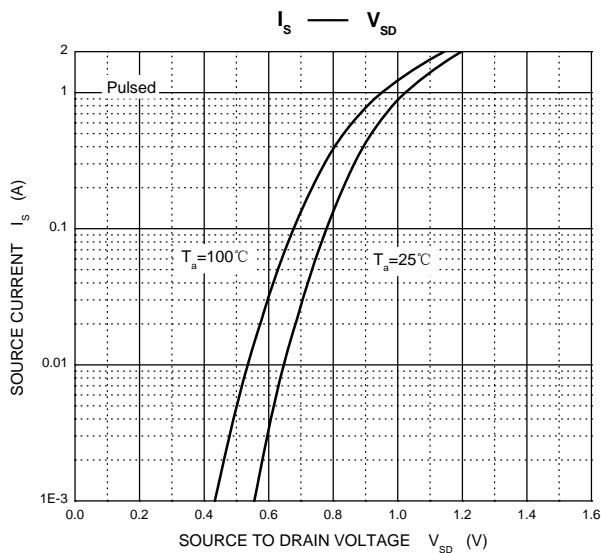
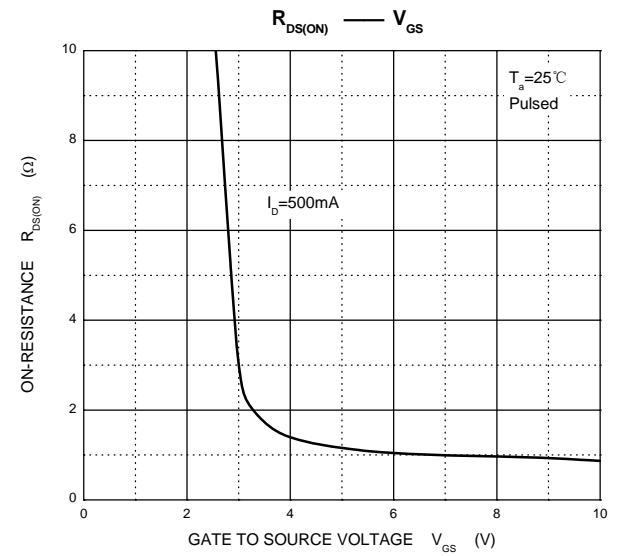
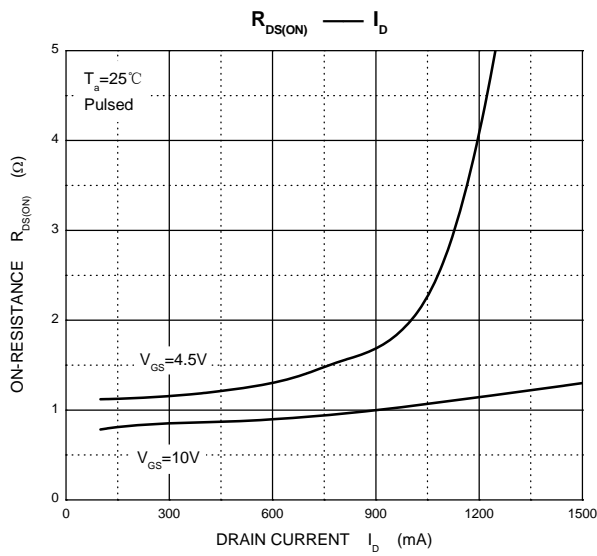
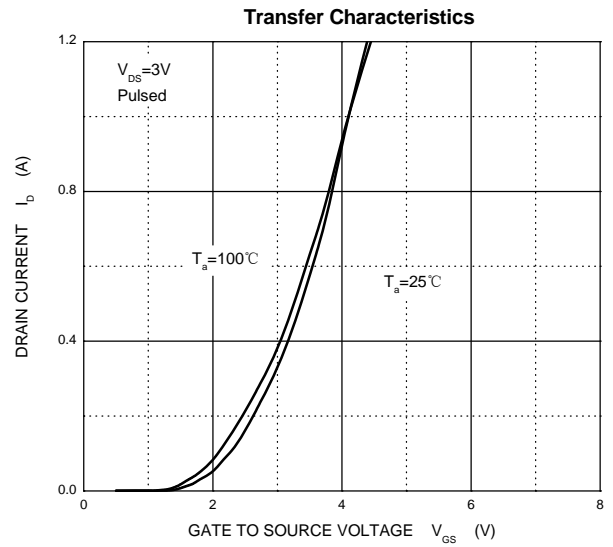
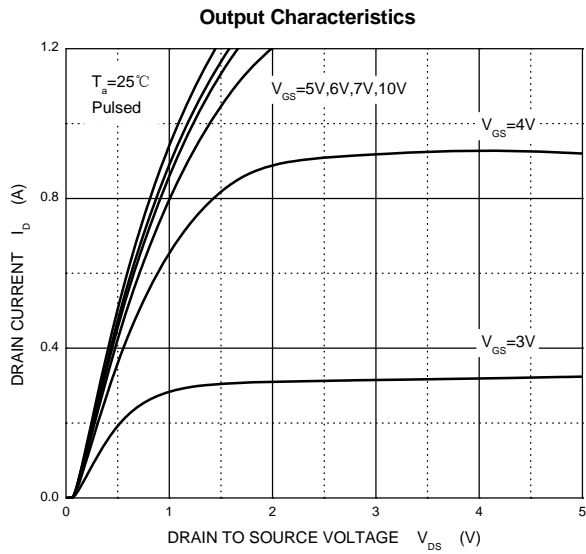

Typical Characteristics

Schottky Characteristics

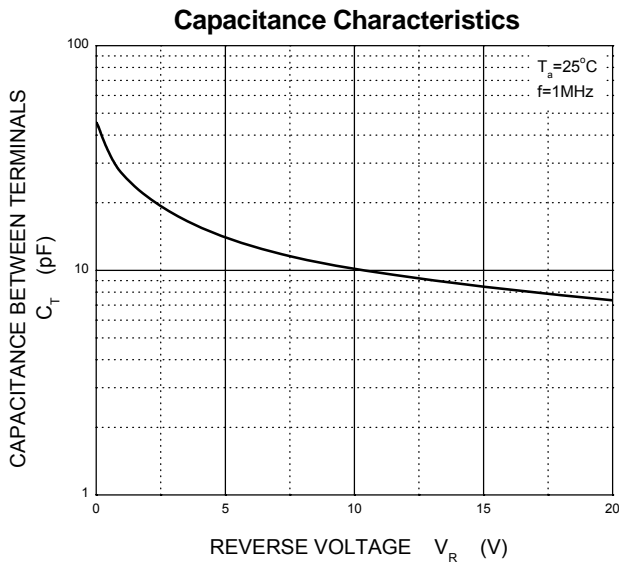
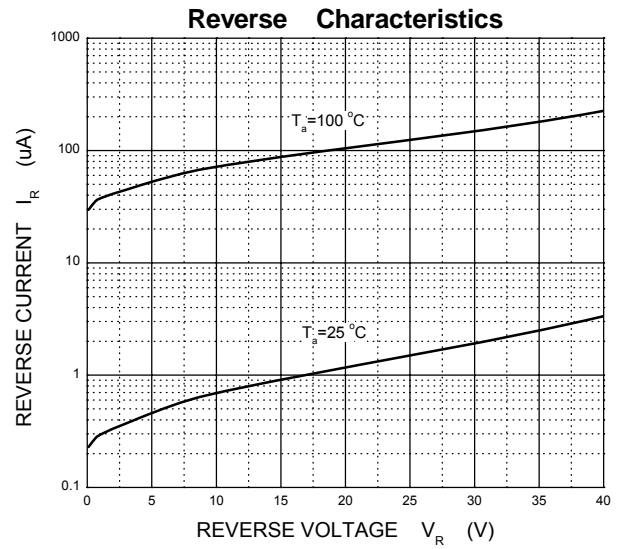
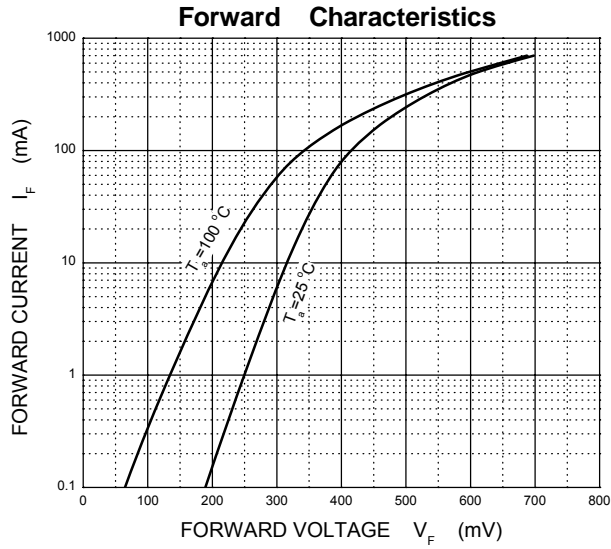

SOT-363 Package Outline Dimensions

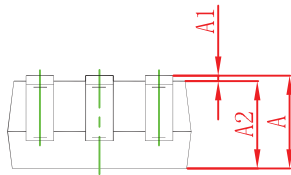
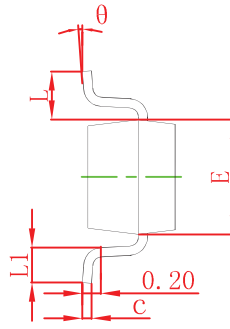
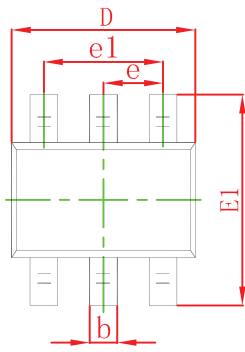

Symbol	Dimensions In Millimeters		Dimensions In Inches	
	Min	Max	Min	Max
A	0.900	1.100	0.035	0.043
A1	0.000	0.100	0.000	0.004
A2	0.900	1.000	0.035	0.039
b	0.150	0.350	0.006	0.014
c	0.100	0.150	0.004	0.006
D	2.000	2.200	0.079	0.087
E	1.150	1.350	0.045	0.053
E1	2.150	2.400	0.085	0.094
e	0.650 TYP		0.026 TYP	
e1	1.200	1.400	0.047	0.055
L	0.525 REF		0.021 REF	
L1	0.260	0.460	0.010	0.018
theta	0°	8°	0°	8°

SOT-363 Suggested Pad Layout

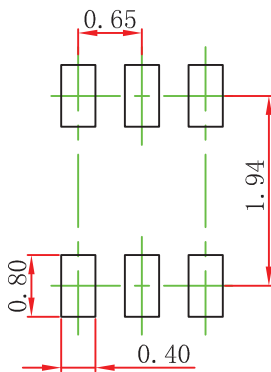

Note:

1. Controlling dimension: in millimeters.
2. General tolerance: $\pm 0.05\text{mm}$.
3. The pad layout is for reference purposes only.

NOTICE

JCET reserve the right to make modifications, enhancements, improvements, corrections or other changes without further notice to any product herein. JCET does not assume any liability arising out of the application or use of any product described herein.

SOT-363 Tape and Reel

SOT-363 Embossed Carrier Tape

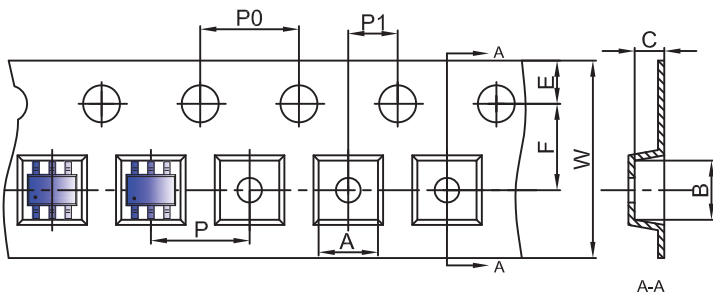

Packaging Description:

SOT-363 parts are shipped in tape. The carrier tape is made from a dissipative (carbon filled) polycarbonate resin. The cover tape is a multilayer film (Heat Activated Adhesive in nature) primarily composed of polyester film, adhesive layer, sealant, and anti-static sprayed agent. These reeled parts in standard option are shipped with 3,000 units per 7" or 17.8cm diameter reel. The reels are clear in color and is made of polystyrene plastic (anti-static coated).

Dimensions are in millimeter										
Pkg type	A	B	C	d	E	F	P0	P	P1	W
SOT-363	2.25	2.55	1.20	Ø1.50	1.75	3.50	4.00	4.00	2.00	8.00

SOT-363 Tape Leader and Trailer

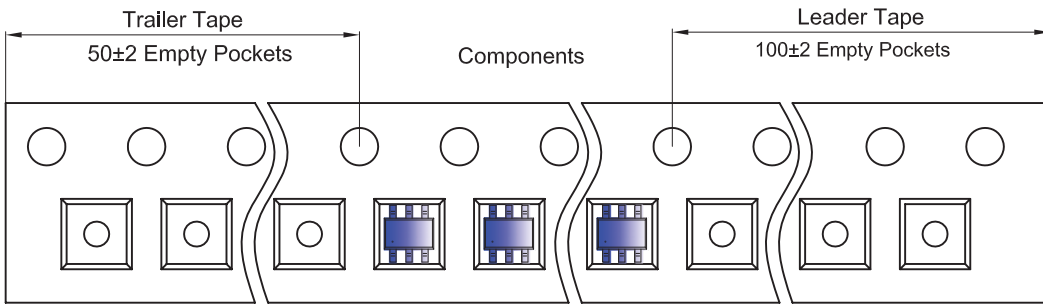

SOT-363 Reel

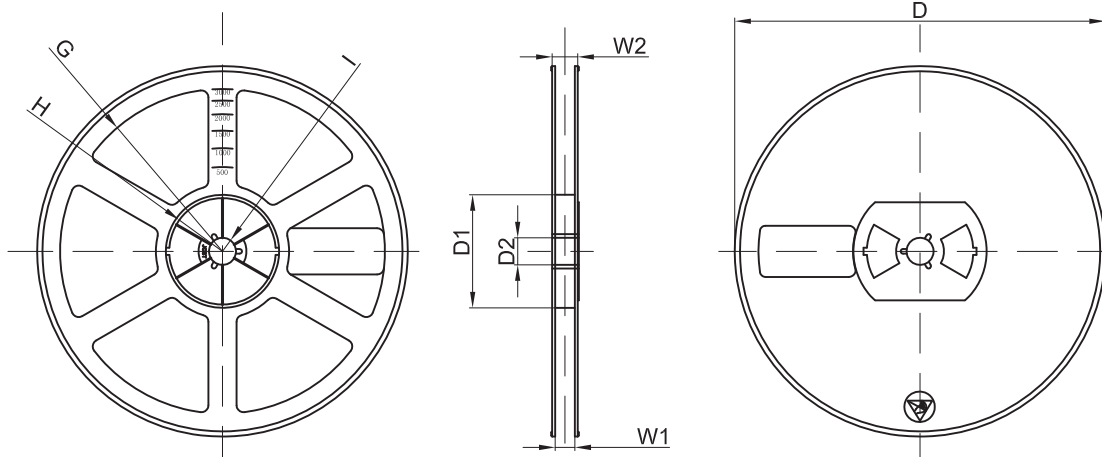

Dimensions are in millimeter								
Reel Option	D	D1	D2	G	H	I	W1	W2
7" Dia	Ø178.00	54.40	13.00	R78.00	R25.60	R6.50	9.50	12.30

REEL	Reel Size	Box	Box Size(mm)	Carton	Carton Size(mm)	G.W.(kg)
3000 pcs	7 inch	45,000 pcs	203×203×195	180,000 pcs	438×438×220	