

Standard Rectifier

$$V_{RRM} = 800V$$

$$I_{FAV} = 45A$$

$$V_F = 1.23V$$

Single Diode

Part number

DSI45-08A

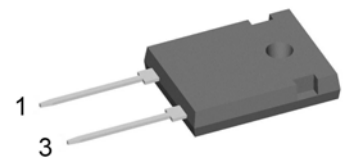

Backside: cathode

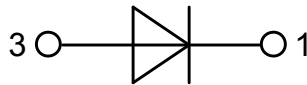

Features / Advantages:

- Planar passivated chips
- Very low leakage current
- Very low forward voltage drop
- Improved thermal behaviour

Applications:

- Diode for main rectification
- For single and three phase bridge configurations

Package: TO-247

- Industry standard outline
- RoHS compliant
- Epoxy meets UL 94V-0

Rectifier				Ratings		
Symbol	Definition	Conditions	min.	typ.	max.	Unit
V_{RSM}	max. non-repetitive reverse blocking voltage	$T_{VJ} = 25^{\circ}C$			900	V
V_{RRM}	max. repetitive reverse blocking voltage	$T_{VJ} = 25^{\circ}C$			800	V
I_R	reverse current, drain current	$V_R = 800 V$	$T_{VJ} = 25^{\circ}C$		40	μA
		$V_R = 800 V$	$T_{VJ} = 150^{\circ}C$		1.5	mA
V_F	forward voltage drop	$I_F = 45 A$	$T_{VJ} = 25^{\circ}C$		1.26	V
					1.57	V
		$I_F = 90 A$	$T_{VJ} = 150^{\circ}C$		1.23	V
					1.66	V
I_{FAV}	average forward current	$T_C = 130^{\circ}C$ 180° sine	$T_{VJ} = 175^{\circ}C$		45	A
V_{FO}	threshold voltage	} for power loss calculation only	$T_{VJ} = 175^{\circ}C$		0.81	V
r_F	slope resistance				9.1	m Ω
R_{thJC}	thermal resistance junction to case				0.55	K/W
R_{thCH}	thermal resistance case to heatsink			0.25		K/W
P_{tot}	total power dissipation		$T_C = 25^{\circ}C$		270	W
I_{FSM}	max. forward surge current	t = 10 ms; (50 Hz), sine	$T_{VJ} = 45^{\circ}C$		480	A
				t = 8,3 ms; (60 Hz), sine	$V_R = 0 V$	520
		t = 10 ms; (50 Hz), sine	$T_{VJ} = 150^{\circ}C$		410	A
				t = 8,3 ms; (60 Hz), sine	$V_R = 0 V$	440
I^2t	value for fusing	t = 10 ms; (50 Hz), sine	$T_{VJ} = 45^{\circ}C$		1.15	kA ² s
				t = 8,3 ms; (60 Hz), sine	$V_R = 0 V$	1.13
		t = 10 ms; (50 Hz), sine	$T_{VJ} = 150^{\circ}C$		840	A ² s
				t = 8,3 ms; (60 Hz), sine	$V_R = 0 V$	805
C_J	junction capacitance	$V_R = 400 V; f = 1 MHz$	$T_{VJ} = 25^{\circ}C$		18	pF

Package TO-247			Ratings			
Symbol	Definition	Conditions	min.	typ.	max.	Unit
I_{RMS}	RMS current	per terminal			70	A
T_{stg}	storage temperature		-55		150	°C
T_{vj}	virtual junction temperature		-40		175	°C
Weight				6		g
M_D	mounting torque		0.8		1.2	Nm
F_C	mounting force with clip		20		120	N

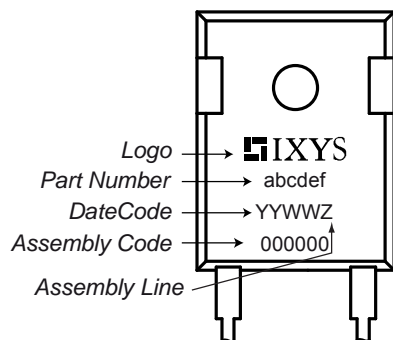
Product Marking

Ordering	Part Number	Marking on Product	Delivery Mode	Quantity	Code No.
Standard	DSI45-08A	DSI45-08A	Tube	30	471887

Similar Part	Package	Voltage class
DSI45-12A	TO-247AD (2)	1200
DSI45-16A	TO-247AD (2)	1600
DSI45-16AR	ISOPLUS247 (2)	1600

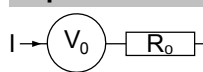
Equivalent Circuits for Simulation
** on die level*
 $T_{vj} = 175^{\circ}\text{C}$

Rectifier

$V_{0\max}$	threshold voltage	0.81	V
$R_{0\max}$	slope resistance *	6.5	mΩ

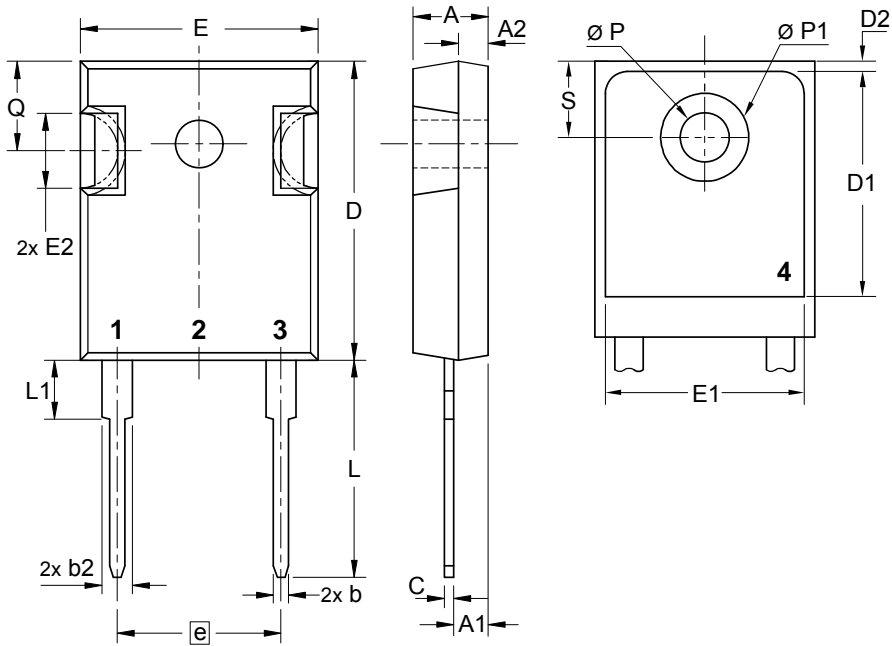
Outlines TO-247



Sym.	Inches		Millimeter	
	min.	max.	min.	max.
A	0.185	0.209	4.70	5.30
A1	0.087	0.102	2.21	2.59
A2	0.059	0.098	1.50	2.49
D	0.819	0.845	20.79	21.45
E	0.610	0.640	15.48	16.24
E2	0.170	0.216	4.31	5.48
e	0.430 BSC		10.92 BSC	
L	0.780	0.800	19.80	20.30
L1	-	0.177	-	4.49
Ø P	0.140	0.144	3.55	3.65
Q	0.212	0.244	5.38	6.19
S	0.242 BSC		6.14 BSC	
b	0.039	0.055	0.99	1.40
b2	0.065	0.094	1.65	2.39
b4	0.102	0.135	2.59	3.43
c	0.015	0.035	0.38	0.89
D1	0.515	-	13.07	-
D2	0.020	0.053	0.51	1.35
E1	0.530	-	13.45	-
Ø P1	-	0.29	-	7.39



Rectifier

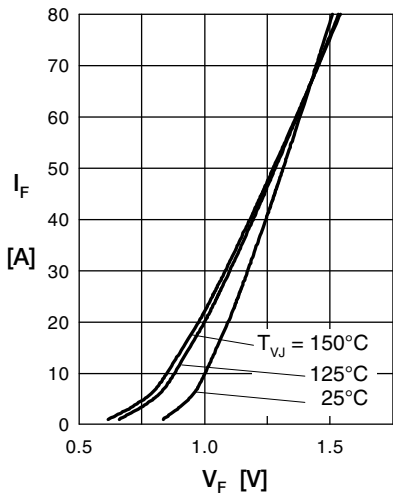

Fig. 1 Forward current versus voltage drop per diode

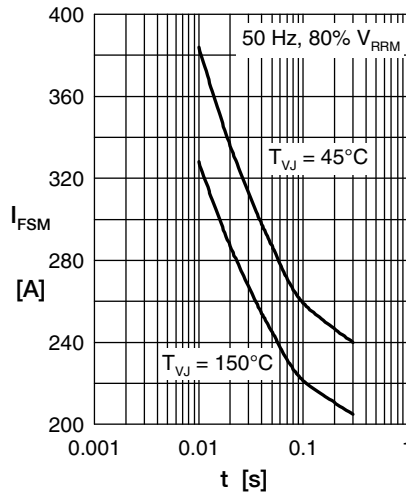

Fig. 2 Surge overload current

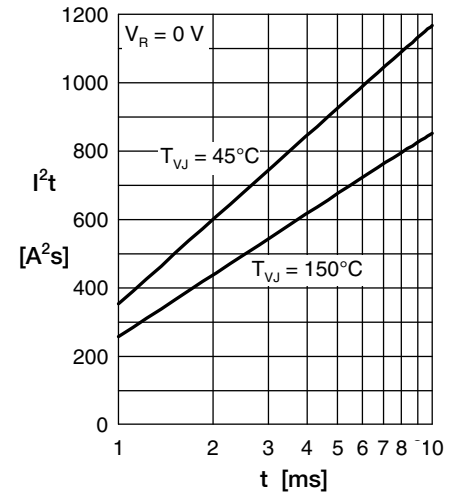

Fig. 3 I^2t versus time per diode

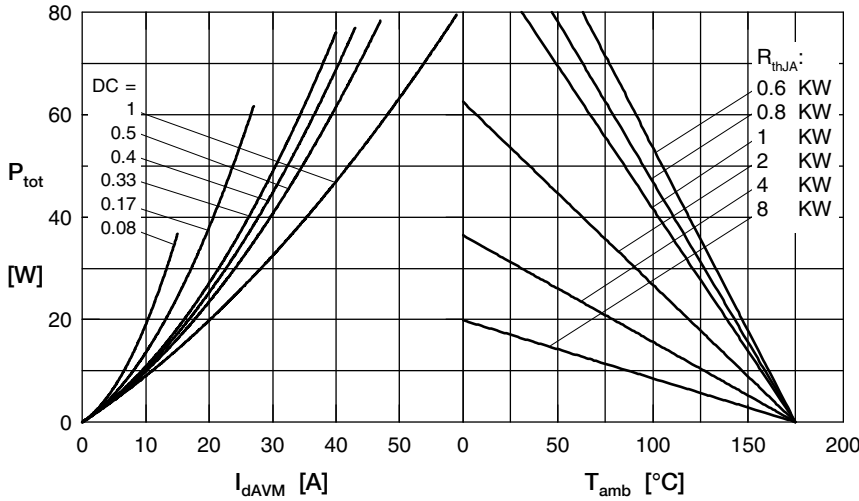

Fig. 4 Power dissipation vs. direct output current & ambient temperature

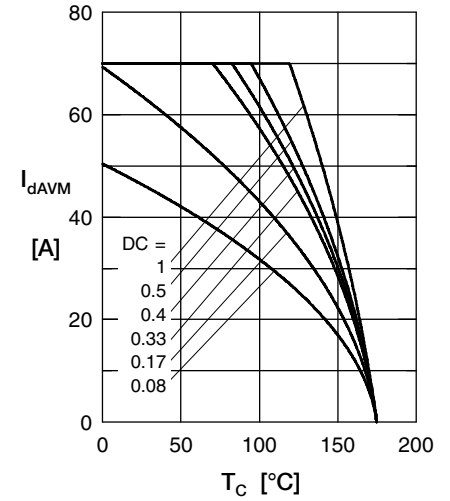

Fig. 5 Max. forward current vs. case temperature

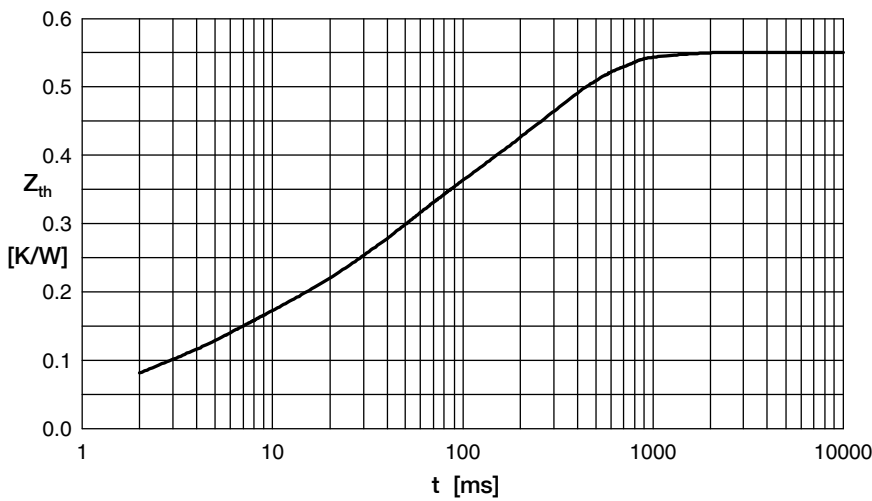

Fig. 6 Transient thermal impedance junction to case

i	R _i	t _i
1	0.033	0.0006
2	0.095	0.0039
3	0.164	0.033
4	0.258	0.272