



# IMP12-1B5PSVC0C

IMP

INDUCTIVE PROXIMITY SENSORS

**SICK**  
Sensor Intelligence.



Illustration may differ



## Ordering information

Type	Part no.
IMP12-1B5PSVC0C	6050119

Other models and accessories → [www.sick.com/IMP](http://www.sick.com/IMP)

## Detailed technical data

### Features

<b>Housing</b>	Cylindrical thread design
<b>Thread size</b>	M12 1
<b>Diameter</b>	Ø 12 mm
<b>Pressure resistance</b>	≤ 500 bar
<b>Sensing range S<sub>n</sub></b>	1.5 mm
<b>Safe sensing range S<sub>a</sub></b>	1.2 mm
<b>Installation type</b>	Flush
<b>Switching frequency</b>	600 Hz
<b>Connection type</b>	Male connector M12, 4-pin
<b>Switching output</b>	PNP
<b>Output function</b>	NO
<b>Electrical wiring</b>	DC 3-wire
<b>Enclosure rating</b>	IP68 <sup>1)</sup>
<b>Special features</b>	High pressure resistant

<sup>1)</sup> Sensing face.

### Mechanics/electronics

<b>Supply voltage</b>	10 V DC ... 30 V DC
<b>Ripple</b>	≤ 20 % <sup>1)</sup>
<b>Voltage drop</b>	≤ 2 V <sup>2)</sup>
<b>Current consumption</b>	≤ 10 mA <sup>3)</sup>

<sup>1)</sup> Of V<sub>S</sub>.

<sup>2)</sup> With I<sub>a</sub> = 200 mA.

<sup>3)</sup> Without load.

<sup>4)</sup> Typ. 8%.

<sup>5)</sup> U<sub>b</sub> = 20 ... 30 VDC.

<sup>6)</sup> T<sub>a</sub> = 23 °C ± 5 °C.

<sup>7)</sup> Front.

<b>Time delay before availability</b>	≤ 50 ms
<b>Hysteresis</b>	1 % ... 15 % <sup>4)</sup>
<b>Reproducibility</b>	≤ 7 % <sup>5) 6)</sup>
<b>Temperature drift (of S<sub>r</sub>)</b>	≤ 15 %
<b>EMC</b>	According to EN 60947-5-2
<b>Continuous current I<sub>a</sub></b>	≤ 200 mA
<b>Vacuum resistance</b>	10 <sup>-8</sup> Torr <sup>7)</sup>
<b>Large sealing ring</b>	5.3 mm x 2.4 mm
<b>Size support ring</b>	10 mm x 5.9 mm x 1 mm
<b>Short-circuit protection</b>	✓
<b>Reverse polarity protection</b>	✓
<b>Shock and vibration resistance</b>	30 g, 11 ms / 10 ... 55 Hz, 1 mm
<b>Ambient operating temperature</b>	-25 °C ... +80 °C
<b>Housing material</b>	Stainless steel, V2A
<b>Sensing face material</b>	Ceramics, ceramics
<b>Sealing ring material</b>	FPM
<b>Housing length</b>	69 mm
<b>Thread length</b>	38 mm
<b>Tightening torque, max.</b>	≤ 40 Nm

<sup>1)</sup> Of V<sub>S</sub>.

<sup>2)</sup> With I<sub>a</sub> = 200 mA.

<sup>3)</sup> Without load.

<sup>4)</sup> Typ. 8%.

<sup>5)</sup> U<sub>b</sub> = 20 ... 30 VDC.

<sup>6)</sup> T<sub>a</sub> = 23 °C ± 5 °C.

<sup>7)</sup> Front.

### Reduction factors

<b>Note</b>	The values are reference values which may vary
<b>St37 steel (Fe)</b>	1
<b>Stainless steel (V2A, 304)</b>	Approx. 0.75
<b>Aluminum (Al)</b>	Approx. 0.2
<b>Copper (Cu)</b>	Approx. 0.12
<b>Brass (Br)</b>	Approx. 0.34

### Installation note

<b>Remark</b>	Associated graphic see "Installation"
---------------	---------------------------------------

### Classifications

<b>ECl@ss 5.0</b>	27270101
<b>ECl@ss 5.1.4</b>	27270101
<b>ECl@ss 6.0</b>	27270101
<b>ECl@ss 6.2</b>	27270101
<b>ECl@ss 7.0</b>	27270101
<b>ECl@ss 8.0</b>	27270101

<b>ECl@ss 8.1</b>	27270101
<b>ECl@ss 9.0</b>	27270101
<b>ETIM 5.0</b>	EC002714
<b>ETIM 6.0</b>	EC002714
<b>UNSPSC 16.0901</b>	39122230

## Installation note

Flush installation

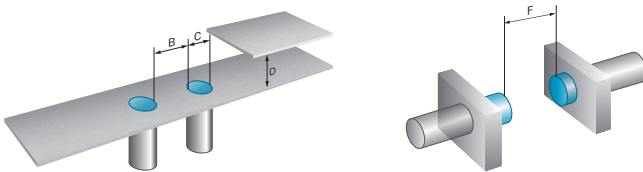

## Connection diagram

cd-007

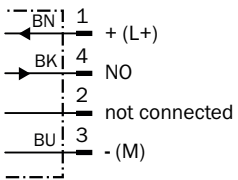

## Dimensional drawing (Dimensions in mm (inch))



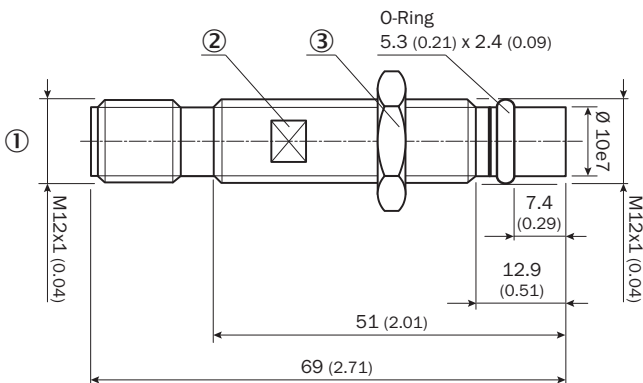





IMP12-xxxxxxxC, 69 mm



- ① Male connector M12, 4-pin
- ② Width across 10
- ③ Width across 17

## Recommended accessories

Other models and accessories → [www.sick.com/IMP](http://www.sick.com/IMP)

	Brief description	Type	Part no.
Other mounting accessories			
		O-ring IMP12	5327494
		Support ring IMP12	5327496
Plug connectors and cables			
	Head A: female connector, M12, 4-pin, straight, A-coded Head B: open cable ends Cable: Sensor/actuator cable, PUR, halogen-free, unshielded, 2 m	YF2A14-020UB3XLEAX	2095607
	Head A: female connector, M12, 4-pin, straight, A-coded Head B: open cable ends Cable: Sensor/actuator cable, PVC, unshielded, 2 m	YF2A14-020VB3XLEAX	2096234
	Head A: female connector, M12, 4-pin, straight, A-coded Head B: open cable ends Cable: Sensor/actuator cable, PUR, halogen-free, unshielded, 5 m	YF2A14-050UB3XLEAX	2095608
	Head A: female connector, M12, 4-pin, straight, A-coded Head B: open cable ends Cable: Sensor/actuator cable, PVC, unshielded, 5 m	YF2A14-050VB3XLEAX	2096235
	Head A: female connector, M12, 4-pin, angled, A-coded Head B: open cable ends Cable: Sensor/actuator cable, PUR, halogen-free, unshielded, 2 m	YG2A14-020UB3XLEAX	2095766
	Head A: female connector, M12, 4-pin, angled, A-coded Head B: open cable ends Cable: Sensor/actuator cable, PVC, unshielded, 2 m	YG2A14-020VB3XLEAX	2095895
	Head A: female connector, M12, 4-pin, angled, A-coded Head B: open cable ends Cable: Sensor/actuator cable, PUR, halogen-free, unshielded, 5 m	YG2A14-050UB3XLEAX	2095767
	Head A: female connector, M12, 4-pin, angled, A-coded Head B: open cable ends Cable: Sensor/actuator cable, PVC, unshielded, 5 m	YG2A14-050VB3XLEAX	2095897

## SICK AT A GLANCE

SICK is one of the leading manufacturers of intelligent sensors and sensor solutions for industrial applications. A unique range of products and services creates the perfect basis for controlling processes securely and efficiently, protecting individuals from accidents and preventing damage to the environment.

We have extensive experience in a wide range of industries and understand their processes and requirements. With intelligent sensors, we can deliver exactly what our customers need. In application centers in Europe, Asia and North America, system solutions are tested and optimized in accordance with customer specifications. All this makes us a reliable supplier and development partner.

Comprehensive services complete our offering: SICK LifeTime Services provide support throughout the machine life cycle and ensure safety and productivity.

For us, that is “Sensor Intelligence.”

## WORLDWIDE PRESENCE:

Contacts and other locations –[www.sick.com](http://www.sick.com)