



N-Channel Enhancement Mode Power MOSFET

MTN4N60BFP

BV _{DSS}	600V
I _D @ V _{GS} =10V, T _C =25°C	4.0A
R _{DS(on)(TYP)} @ V _{GS} =10V, I _D =2.4A	1.8Ω

Description

The MTN4N60BFP is a N-channel enhancement-mode MOSFET, providing the designer with the best combination of fast switching, ruggedized device design, low on-resistance and cost effectiveness. The TO-220FP package is universally preferred for all commercial-industrial applications

Features

- Low On Resistance
- Simple Drive Requirement
- Low Gate Charge
- Fast Switching Characteristic
- Insulating package, front/back side insulating voltage=2500V(AC)
- RoHS compliant package

Applications

- Open Framed Power Supply
- Adapter
- STB

Ordering Information

Device	Package	Shipping
MTN4N60BFP-0-UB-S	TO-220FP (RoHS compliant package)	50 pcs/tube, 20 tubes/box, 4 boxes / carton

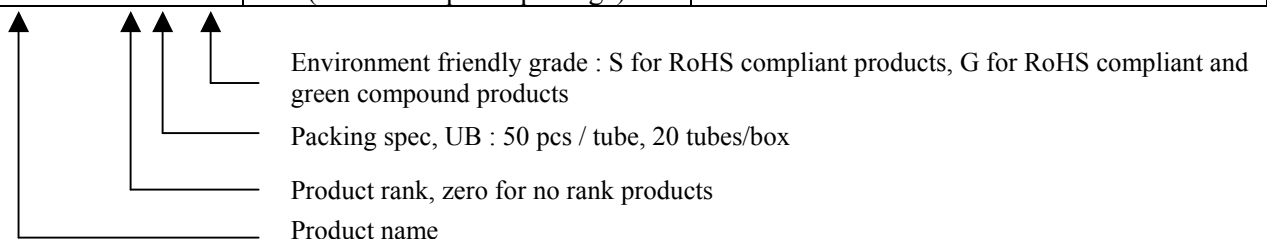

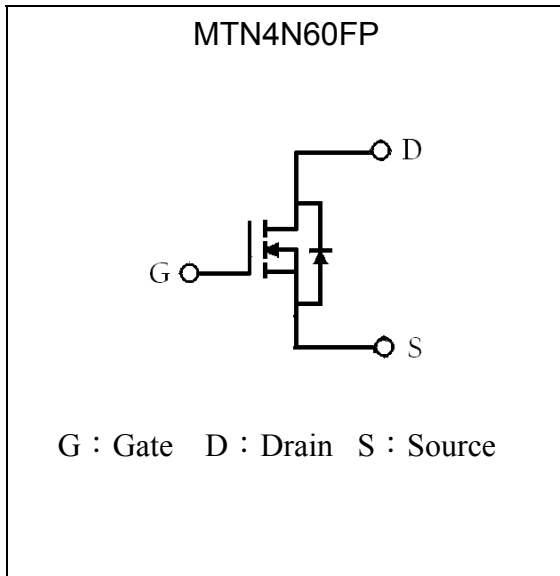
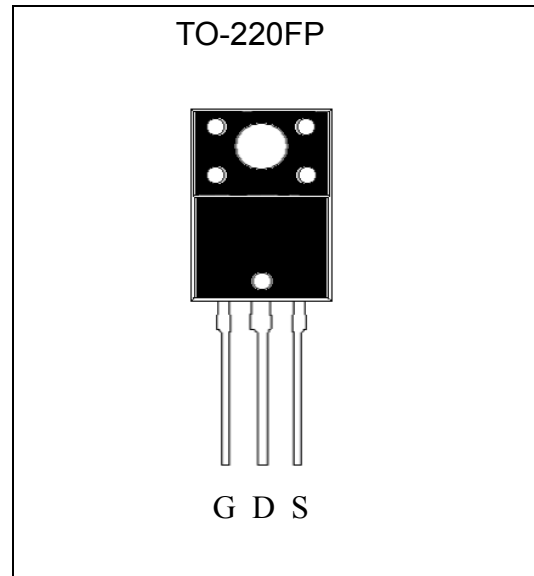
Symbol

Outline

Absolute Maximum Ratings ($T_C=25^\circ\text{C}$)

Parameter	Symbol	Limits	Unit
Drain-Source Voltage	V_{DS}	600	V
Gate-Source Voltage	V_{GS}	± 30	V
Continuous Drain Current	I_D	4*	A
Continuous Drain Current @ $T_C=100^\circ\text{C}$	I_D	2.5*	
Pulsed Drain Current @ $V_{GS}=10\text{V}$ (Note 1)	I_{DM}	16*	
Avalanche Current (Note 1)	I_{AS}	4	
Single Pulse Avalanche Energy (Note 2)	E_{AS}	58.6	mJ
Repetitive Avalanche Energy (Note 1)	E_{AR}	3.3	
Peak Diode Recovery dv/dt (Note 3)	dv/dt	4.5	V/ns
Maximum Temperature for Soldering @ Lead at 0.125 in(0.318mm) from case for 10 seconds	T_L	300	$^\circ\text{C}$
Maximum Temperature for Soldering @ Package Body for 10 seconds	T_{PKG}	260	
Total Power Dissipation ($T_C=25^\circ\text{C}$)	P_d	33	W
Linear Derating Factor		0.26	W/ $^\circ\text{C}$
Operating Junction and Storage Temperature	T_j, T_{stg}	-55~+150	$^\circ\text{C}$

*Drain current limited by maximum junction temperature

Note : 1.Repetitive rating; pulse width limited by maximum junction temperature.

2. $I_{AS}=4\text{A}$, $V_{DD}=50\text{V}$, $L=8\text{mH}$, $V_G=10\text{V}$, starting $T_J=+25^\circ\text{C}$.

3. $I_{SD}\leq 4\text{A}$, $di/dt\leq 100\text{A}/\mu\text{s}$, $V_{DD}\leq BV_{DSS}$, starting $T_J=+25^\circ\text{C}$.



Thermal Data

Parameter	Symbol	Value	Unit
Thermal Resistance, Junction-to-case, max	R _{th,j-c}	3.79	°C/W
Thermal Resistance, Junction-to-ambient, max	R _{th,j-a}	62.5	

Characteristics (T_c=25°C, unless otherwise specified)

Symbol	Min.	Typ.	Max.	Unit	Test Conditions
Static					
BV _{DSS}	600	-	-	V	V _{GS} =0V, I _D =250μA, T _j =25°C
ΔBV _{DSS} /ΔT _j	-	0.7	-	V/°C	Reference to 25°C, I _D =250μA
V _{GS(th)}	2.0	-	4.0	V	V _{DS} = V _{GS} , I _D =250μA
*G _{FS}	-	5	-	S	V _{DS} =15V, I _D =2.25A
I _{GSS}	-	-	±100	nA	V _{GS} =±30V
I _{DSS}	-	-	1	μA	V _{DS} =600V, V _{GS} =0V
	-	-	10		V _{DS} =480V, V _{GS} =0V, T _j =125°C
*R _{DS(ON)}	-	1.8	2.2	Ω	V _{GS} =10V, I _D =2.4A
Dynamic					
*Q _g	-	18.8	-	nC	I _D =4A, V _{DD} =300V, V _{GS} =10V
*Q _{gs}	-	3.0	-		
*Q _{gd}	-	8.8	-		
*t _{d(ON)}	-	9.6	-	ns	V _{DD} =300V, I _D =4A, V _{GS} =10V, R _G =10Ω, R _D =75Ω
*t _r	-	11	-		
*t _{d(OFF)}	-	37.2	-		
*t _f	-	14.8	-		
C _{iss}	-	549	-	pF	V _{GS} =0V, V _{DS} =25V, f=1MHz
C _{oss}	-	62	-		
C _{rss}	-	46	-		
Source-Drain Diode					
*V _{SD}	-	-	1.5	V	I _S =4A, V _{GS} =0V
*I _S	-	-	4	A	
*I _{SM}	-	-	16		
*t _{rr}	-	510	-	ns	V _{GS} =0V, I _F =4A, dI _F /dt=100A/μs
*Q _{rr}	-	1.4	-	μC	

*Pulse Test : Pulse Width ≤300μs, Duty Cycle≤2%



Typical Characteristics

Typical Output Characteristics

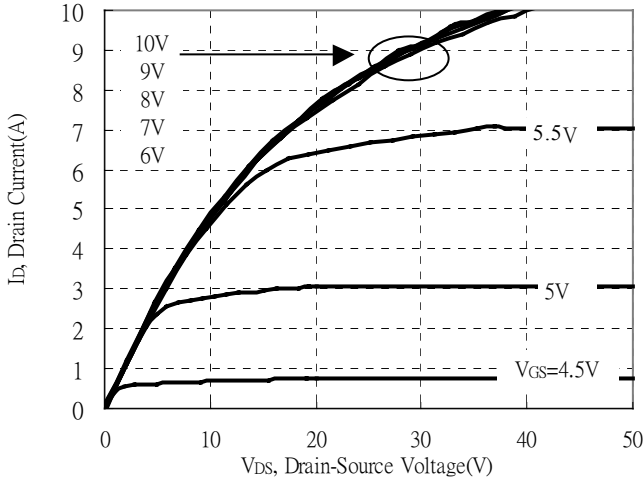

Static Drain-Source On-resistance vs Ambient Temperature

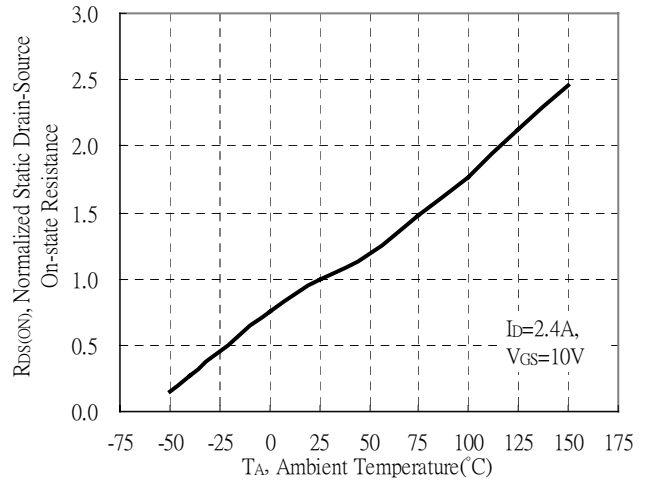

Static Drain-Source On-State resistance vs Drain Current

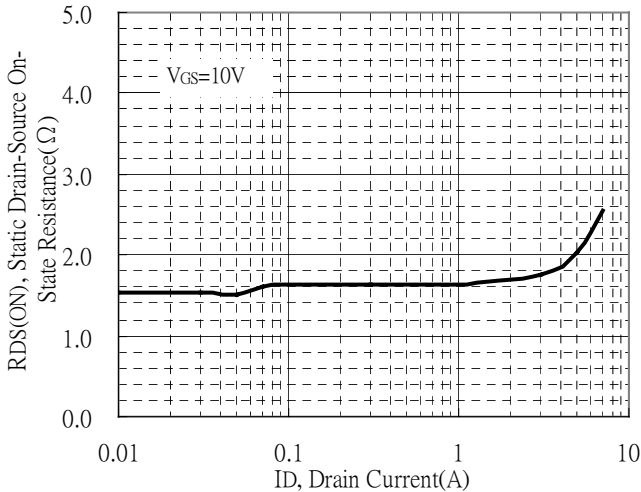

Drain Current vs Gate-Source Voltage

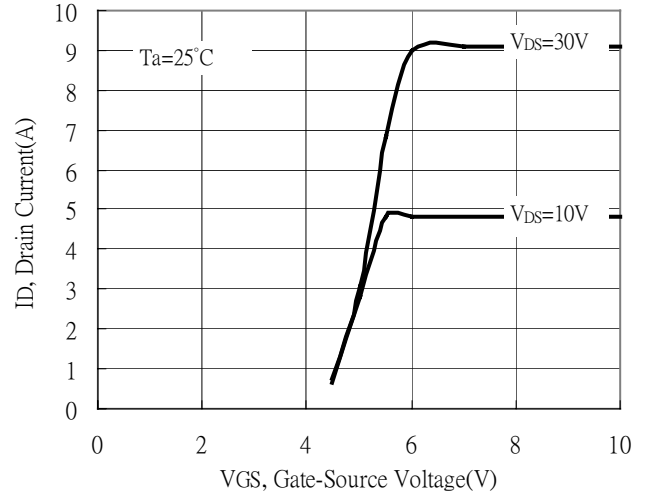

Static Drain-Source On-State Resistance vs Gate-Source Voltage

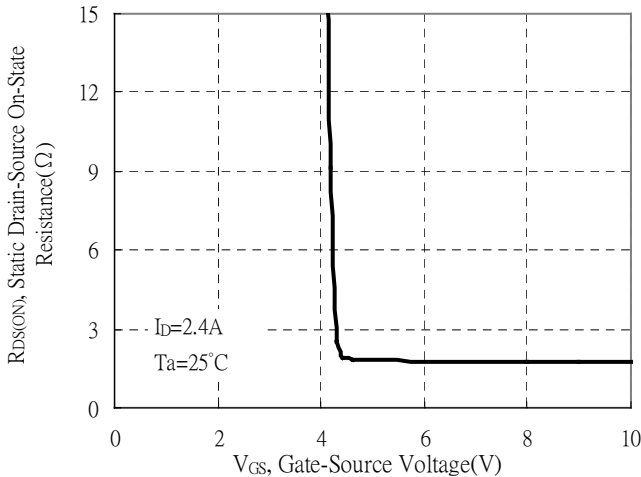

Forward Drain Current vs Source-Drain Voltage

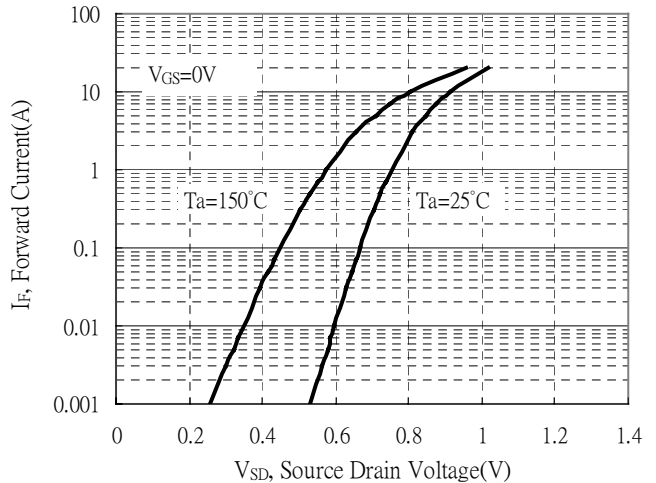



Typical Characteristics(Cont.)

Capacitance vs Reverse Voltage

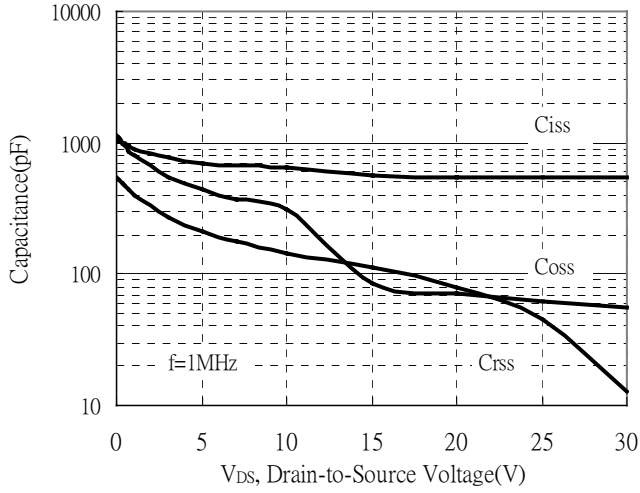

Brekdown Voltage vs Ambient Temperature

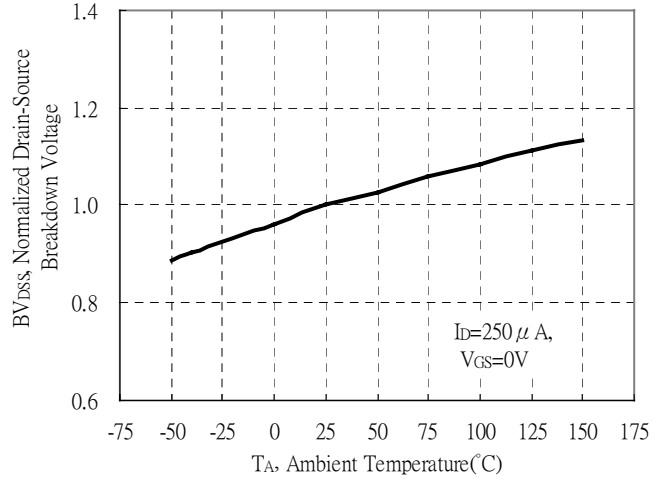

Maximum Safe Operating Area

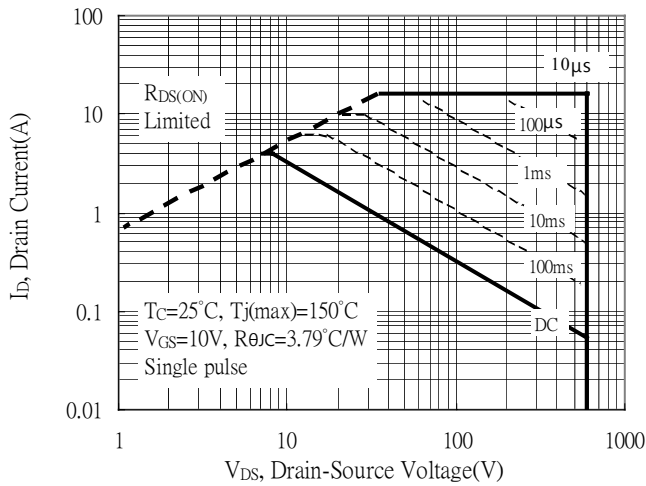

Gate Charge Characteristics

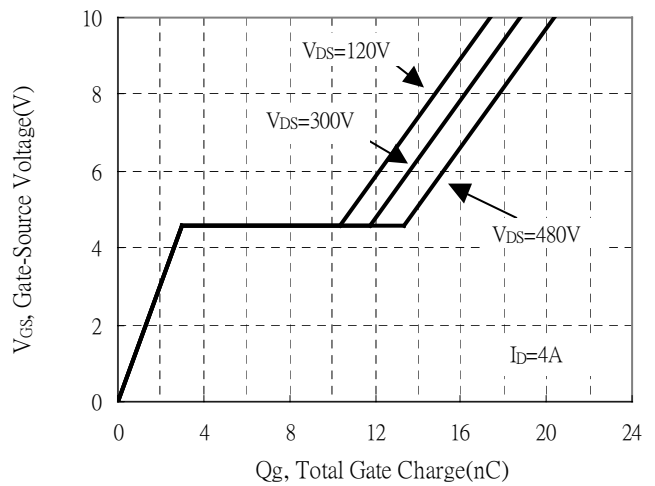

Maximum Drain Current vs Case Temperature

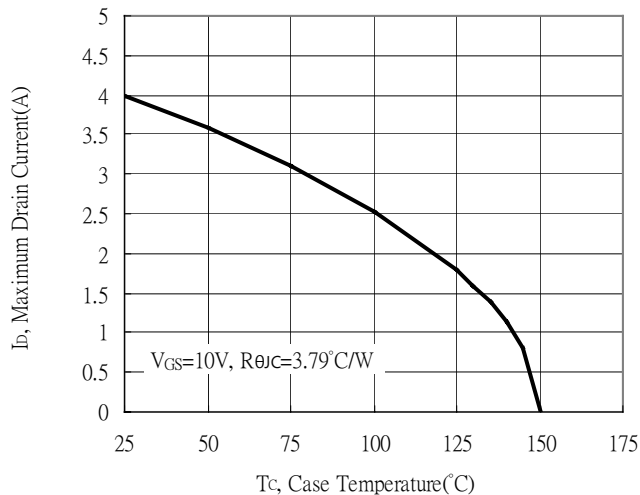

Threshold Voltage vs Junction Temperature

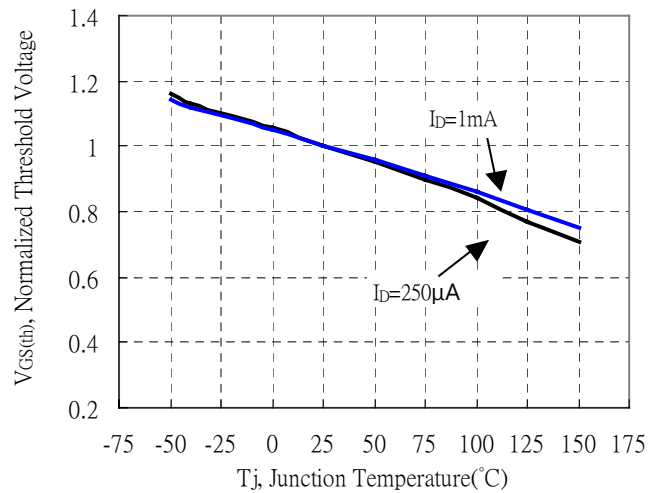



Typical Characteristics(Cont.)

Single Pulse Power Rating, Junction to Case

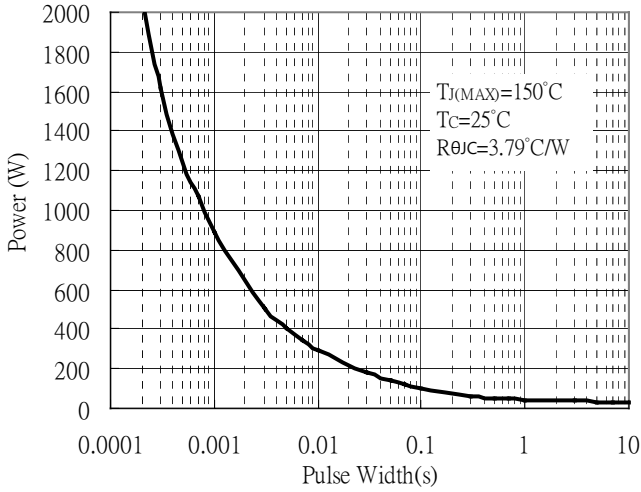

Forward Transfer Admittance vs Drain Current

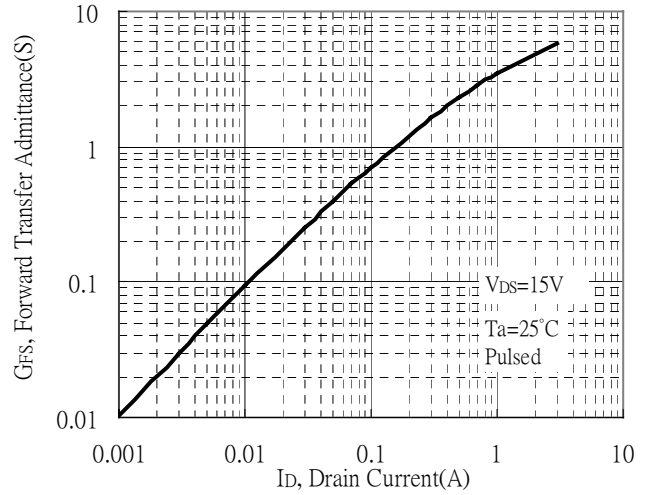

Transient Thermal Response Curves

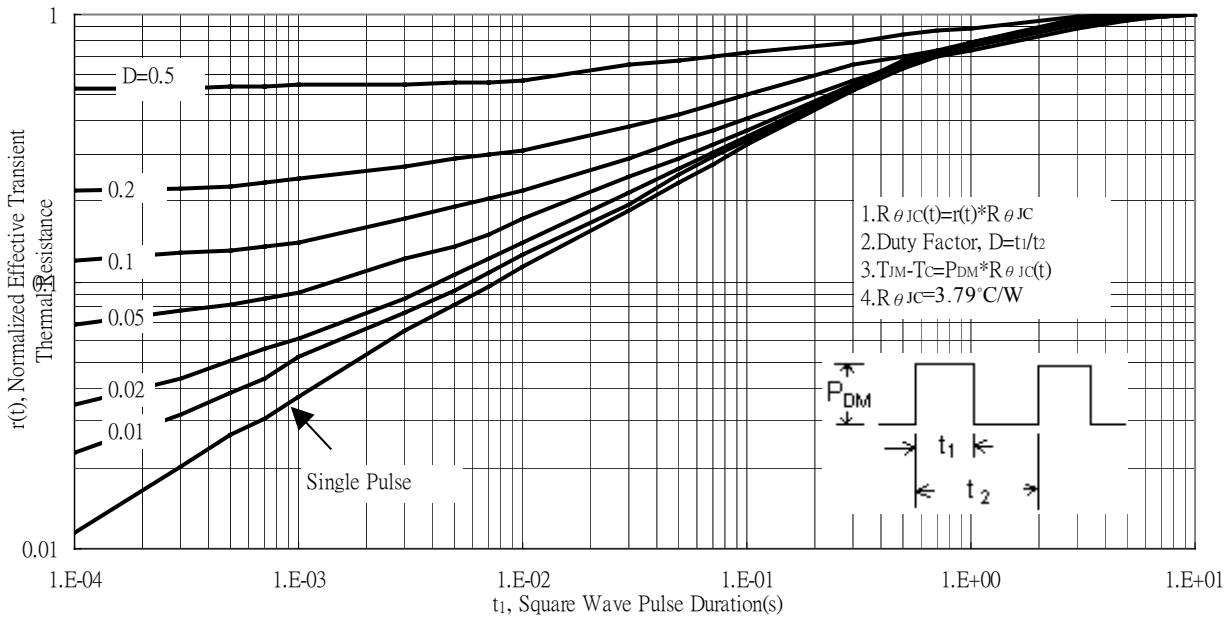

Test Circuits and Waveforms



Gate Charge Test Circuit

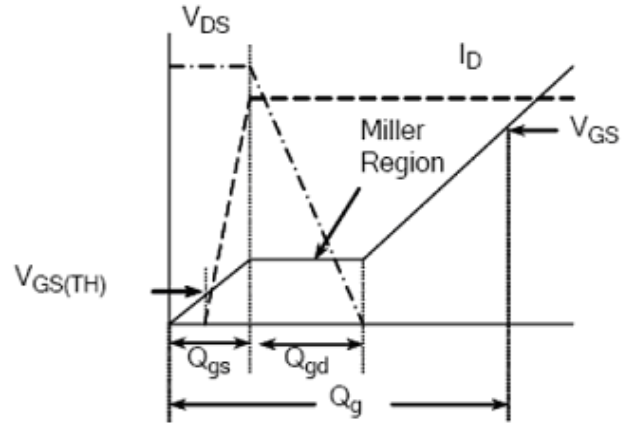

Gate Charge Waveform

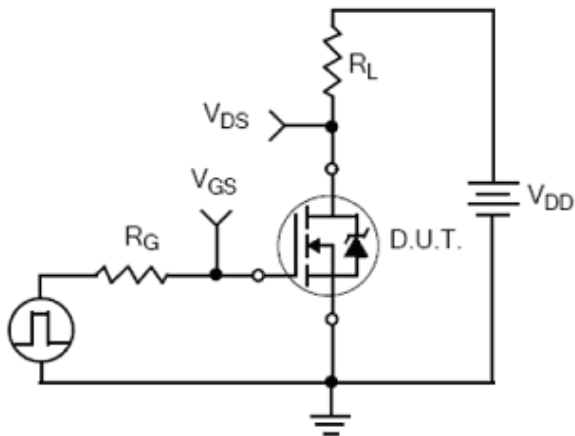

Resistive Switching Test Circuit



Resistive Switching Waveforms

Test Circuits and Waveforms(Cont.)



Diode Reverse Recovery Test Circuit

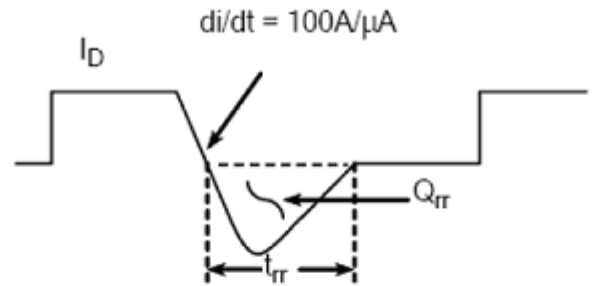

Diode Reverse Recovery Waveform

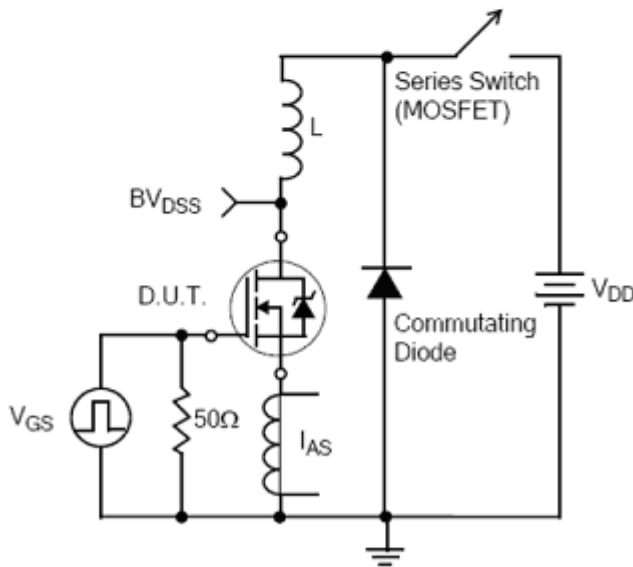

Unclamped Inductive Switching Test Circuit

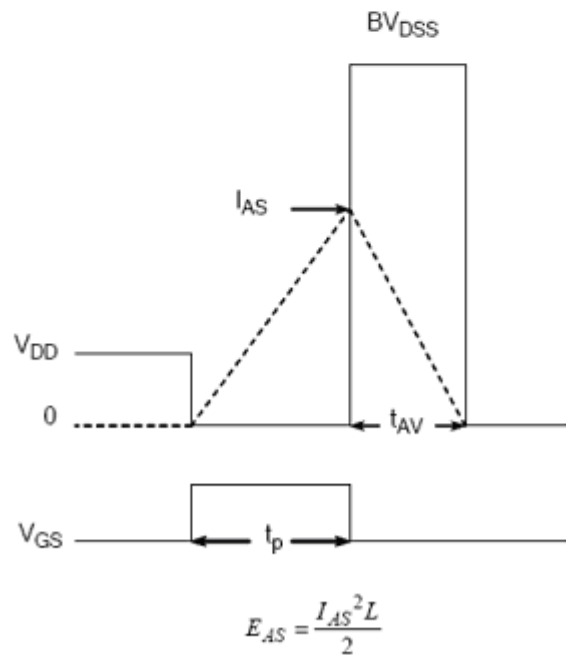

Unclamped Inductive Switching Waveforms

Recommended wave soldering condition

Product	Peak Temperature	Soldering Time
Pb-free devices	260 +0/-5 °C	5 +1/-1 seconds

Recommended temperature profile for IR reflow

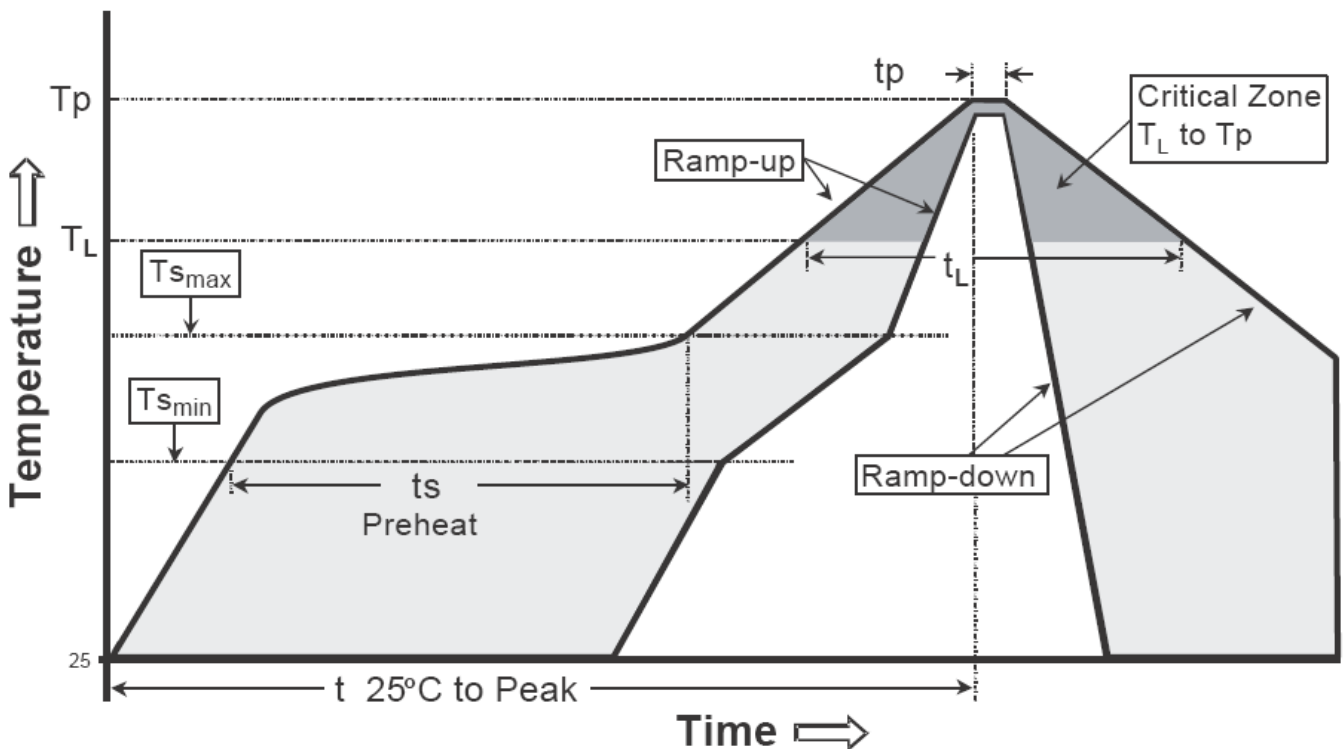

Profile feature	Sn-Pb eutectic Assembly	Pb-free Assembly
Average ramp-up rate (T _{smax} to T _p)	3°C/second max.	3°C/second max.
Preheat		
-Temperature Min(T _{s min})	100°C	150°C
-Temperature Max(T _{s max})	150°C	200°C
-Time(t _{s min} to t _{s max})	60-120 seconds	60-180 seconds
Time maintained above:		
-Temperature (T _L)	183°C	217°C
- Time (t _L)	60-150 seconds	60-150 seconds
Peak Temperature(T _P)	240 +0/-5 °C	260 +0/-5 °C
Time within 5°C of actual peak temperature(tp)	10-30 seconds	20-40 seconds
Ramp down rate	6°C/second max.	6°C/second max.
Time 25 °C to peak temperature	6 minutes max.	8 minutes max.

Note : All temperatures refer to topside of the package, measured on the package body surface.

TO-220FP Dimension

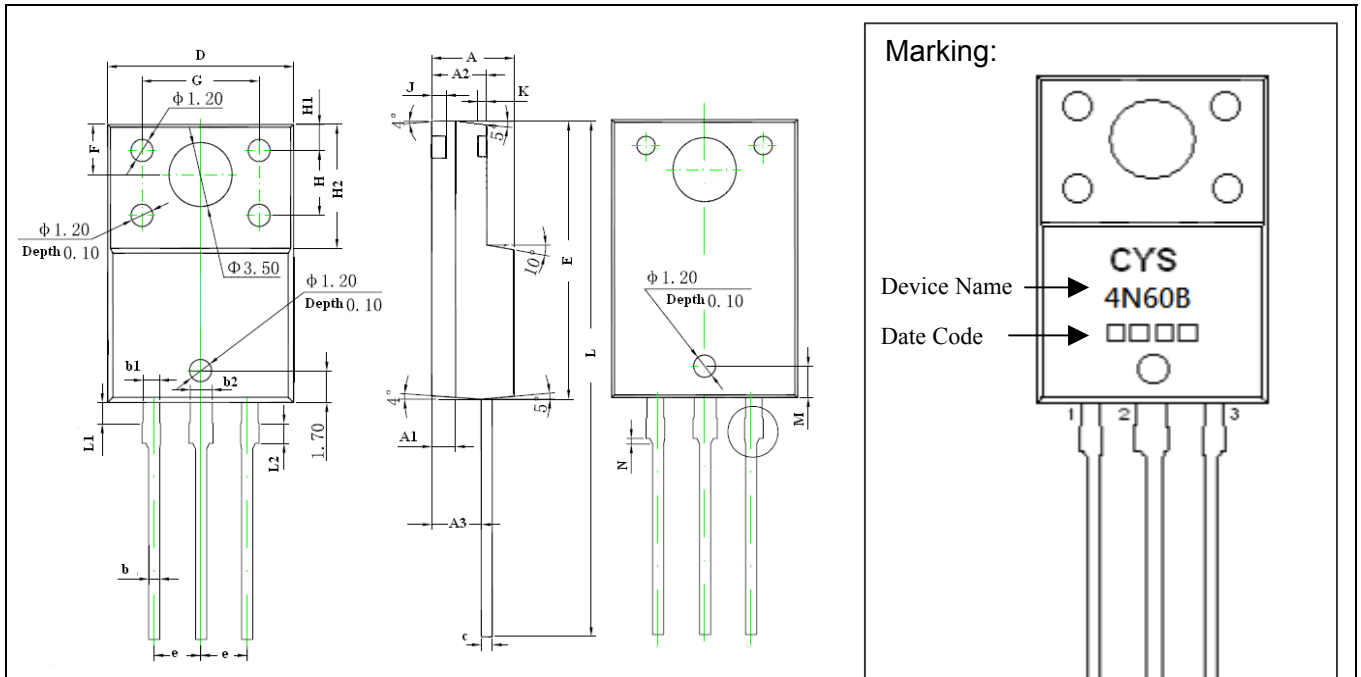

3-Lead TO-220FP Plastic Package
 CYStek Package Code: FP

Marking:

Device Name → **CYS 4N60B**
 Date Code → □□□□

Style: Pin 1.Gate 2.Drain 3.Source

*Typical

DIM	Inches		Millimeters		DIM	Inches		Millimeters	
	Min.	Max.	Min.	Max.		Min.	Max.	Min.	Max.
A	0.171	0.183	4.35	4.65	G	0.246	0.258	6.25	6.55
A1	0.051 REF		1.300 REF		H	0.138 REF		3.50 REF	
A2	0.112	0.124	2.85	3.15	H1	0.055 REF		1.40 REF	
A3	0.102	0.110	2.60	2.80	H2	0.256	0.272	6.50	6.90
b	0.020	0.030	0.50	0.75	J	0.031 REF		0.80 REF	
b1	0.031	0.041	0.80	1.05	K	0.020		0.50 REF	
b2	0.047 REF		1.20 REF		L	1.102	1.118	28.00	28.40
c	0.020	0.030	0.500	0.750	L1	0.043	0.051	1.10	1.30
D	0.396	0.404	10.06	10.26	L2	0.036	0.043	0.92	1.08
E	0.583	0.598	14.80	15.20	M	0.067 REF		1.70 REF	
e	0.100 *		2.54*		N	0.012 REF		0.30 REF	
F	0.106 REF		2.70 REF						

- Notes:** 1.Controlling dimension: millimeters.
 2.Maximum lead thickness includes lead finish thickness, and minimum lead thickness is the minimum thickness of base material.
 3.If there is any question with packing specification or packing method, please contact your local CYStek sales office.

Material:

- Lead: Pure tin plated.
- Mold Compound: Epoxy resin family, flammability solid burning class: UL94V-0.

Important Notice:

- All rights are reserved. Reproduction in whole or in part is prohibited without the prior written approval of CYStek.
- CYStek reserves the right to make changes to its products without notice.
- CYStek **semiconductor products are not warranted to be suitable for use in Life-Support Applications, or systems.**
- CYStek assumes no liability for any consequence of customer product design, infringement of patents, or application assistance.